



**SCOTT
DRAKE**

Driven Beyond Perfection

2016 RETAIL CATALOG

1964-1973 MUSTANG PARTS





Never out of style.™

Introducing the newest addition to the Drake Automotive Group, Legendary Wheel Company.



The new standard in classic Mustang styling.

www.LegendaryWheel.com



We offer quality parts from the top names in the industry



Scott Drake Guarantee Complete **100%** Satisfaction



Whether you are restoring, customizing or enhancing the performance of your vehicle, Scott Drake Enterprises is dedicated to giving you the world's finest parts. For over 30 years, our engineering techniques have offered unrivaled fit, performance and durability under daily conditions. Everyone at Scott Drake Enterprises strives for your complete satisfaction. If you are not happy with a product, for any reason, simply return it to Scott Drake Enterprises within 30 days of purchase* and we will replace it - no questions asked. We stand behind our products one hundred percent, so you can sit behind the wheel with pride.

*Product must be undamaged, in resalable condition.

© Copyright 2016 Drake Automotive Group Inc.

This entire catalog, photographs, line drawings, artwork and text is copyrighted.

Use of said material is strictly prohibited without written consent. Violators will be prosecuted to the fullest extent of the law.

Reproduction of this catalog in any form is a violation of the law.

Prices are subject to change without further notice. Additional freight charges may apply. We are not responsible for typographical errors.

Table of Contents

Accessories.....	4
Audio	8
Brakes	10
Bumpers	22
Convertible	24
Cooling	29
Decals & Striping	35
Door Parts	41
Electrical & Lighting	54
Emblems	71
Engine	75
Exhaust System.....	90
Fuel System	94
Grille	101
Hardware	103
Heater & A/C	111
Interior & Upholstery	118
Keys, Locks, & Latches	171
Literature	175
Mirrors	179
Molding	181
Paint, Tools, & Resto. Supplies	184
Rubber & Weather Stripping	188
Sheet Metal & Body Parts	195
Steering	210
Suspension	220
Transmission & Drivetrain.....	227
Trunk Compartment	238
Wheels	241
Windows	247
Wipers	250
Index	252

The Ford Trademark Licensing Program

All the parts represented with the O.L.P. logo are reproduced to the rigid quality standards and regulations of the Ford Motor Company. Working close with Ford and maintaining a strong relationship assures you the highest quality, most accurate reproductions.

Look for the trademark licensing sticker on trademarked products, because with it, you are assured quality and support.



ACCESSORIES

EXTERIOR

COWL COVERS



Scott Drake's Cowl Covers, help eliminate water, dirt, and leaves from entering through the cowl vent. The use of

Poly Methyl Methacrylate plastic (PMMA) helps prevent rusty cowls and soggy carpet that can lead to rusty floors.

Year	Part No.	Description	List
64-66	ACC-16741-65	1-Piece	\$29.95 ^{EA}
67-68	ACC-16741-67	2-Pieces	\$29.95 ^{EA}
69-70	ACC-16741-69	1-Piece	\$29.95 ^{EA}

HI PERFORMANCE MOTORS LICENSE PLATE FRAME

Beautiful reproduction of this very rare license plate frame originally available at Shelby's Southern California dealership "Hi Performance Motors" in the 60's. Customers couldn't buy new Shelby's there because it wasn't technically a Ford Dealership. But they could buy Cobras, company cars or used Shelby's right from the factory dealership. Only a fraction of all the Cobras and Shelbys were sold through Hi Performance Motors, making these frames highly sought after and extremely valuable.



HI-PERFORMANCE MOTORS
ACC-LPF-HPM

List
\$49.95^{EA}

SHELBY G.T. LICENSE PLATE FRAMES



Beautiful pressure die cast zinc chrome plated

Shelby G.T. 350 & 500 license plate frames. Ideal for your original Shelby, clone, tow vehicle, or your daily driver to let everyone know you are a Shelby owner or just a loyal Shelby fan! Officially Licensed by Shelby, makes a great gift.



Part No.	List
ACC-LPF-GT350	\$12.95 ^{EA}



Part No.	List
ACC-LPF-GT500	\$12.95 ^{EA}

BUMPER STICKER



Novelty "My Other Car is a Classic Mustang" bumper sticker.



Description	Part No.	List
Classic Mustang	BS-74	\$3.95 ^A

SOLID BRASS LICENSE PLATE FRAME

A very nicely chrome-plated, brass license plate frames with licensed logos.



Description	Part No.	List
Mustang tri-bar	ACC-9233100	\$29.95
Cobra	ACC-9233205	\$29.95
Running horse	ACC-9233270	\$29.95

MUSTANG LICENSE PLATE FRAME

Chrome-plated housing with blue background and white lettering.



Description	Part No.	List
Ford Mustang	ACC-LPF-MUSTANG	\$84.95 ^{EA}



Description	Part No.	List
1964 1/2	ACC-LPF-64 1/2	\$9.95 ^{EA}
1965	ACC-LPF-65	\$9.95 ^{EA}
1966	ACC-LPF-66	\$9.95 ^{EA}
1967	ACC-LPF-67	\$9.95 ^{EA}
1968	ACC-LPF-68	\$9.95 ^{EA}
1969	ACC-LPF-69	\$9.95 ^{EA}
1970	ACC-LPF-70	\$9.95 ^{EA}

LICENSE PLATE FRAME

Chrome-plated housing with black background and white lettering



Description	Part No.	List
Falcon	ACC-LPF-FALCON	\$9.95 ^{EA}
Bronco	ACC-LPF-BRONCO	\$9.95 ^{EA}
Cougar	ACC-LPF-COUGAR	\$9.95 ^{EA}

FENDER COVERS

From Scott Drake, these are the best fender covers in the industry! Features brilliant three color design, anti-roll tool dam, soft rubberized backing to help prevent scratches and slipping. A small price to pay for protecting costly paint jobs and a "must have" for any car owner.



Description	Part No.	List
Mustang	ACC-300-MUSTANG	\$31.95 ^{EA}
Cougar	ACC-300-COUGAR	\$31.95 ^{EA}
Falcon	ACC-300-FALCON	\$31.95 ^{EA}
Bronco	ACC-300-BRONCO	\$31.95 ^{EA}
Shelby	ACC-300-SHELBY	\$31.95 ^{EA}

SHOP WITH CONFIDENCE! WE OFFER SUPERIOR-QUALITY PARTS FOR ALL YOUR MUSTANG RESTORATION NEEDS.

SUN SHADES



Keep your Classic Ford's dash and interior safe from the sun with Scott Drakes line of fade resistant Sun Shades. Made out of heavy

duty bright white glossy card board, this accordion style Sun Shade features the classic logo for each model that spans the width of the Sun Shade. Folds flat for easy storing when not in use. Reverse side has the Drake Automotive Group logo.



Description	Part No.	List
Mustang	ACC-700-MUSTANG	\$9.95 ^{EA}
Cougar	ACC-700-COUGAR	\$9.95 ^{EA}
Falcon	ACC-700-FALCON	\$9.95 ^{EA}
Bronco	ACC-700-BRONCO	\$9.95 ^{EA}

OWNERS MANUAL WALLETS



Protect your owner's manual, registration and insurance card with an owner's manual wallet from Scott Drake. This official licensed Ford product features black vinyl construction with official logos and lettering on the front. The 3 clear vinyl pockets on the inside make ideal room for all your vehicles' important documents.



Description	Part No.	List
Mustang	ACC-OMW-MUSTANG	\$4.95 ^{EA}
Cougar	ACC-OMW-COUGAR	\$4.95 ^{EA}
Falcon	ACC-OMW-FALCON	\$4.95 ^{EA}
Bronco	ACC-OMW-BRONCO	\$4.95 ^{EA}

MUSTANG SOUND CLOCK



Remember the rumble and roar of one of America's finest sports cars with this 13-inch Ford Mustang Sound Clock. Dial features twelve of the legendary

Mustangs that will take you back to the 1960s through the present. As an added bonus, hear one of twelve authentic recordings of these classic cars at the top of each hour. Will be a great collector's item for muscle car enthusiasts. Light sensor deactivates the sounds when the room is dark. Red border with white stripe.



Description	Part No.	List
Sound	ACC-CLOCK	\$32.50 ^{EA}

CAR COVER



Our light duty car cover is ideal for short term use, or inside for dust prevention. Our heavy duty and premium

covers each offer 3 layers of protection with the middle layer made from Apra®, a revolutionary new material from Amoco that is extremely water resistant yet breathable to allow condensation to escape. Made in the U.S.A. Universal fit.

Description	Part No.	List
Premium (gray)	CC-2	\$84.95 ^{EA}
Heavy duty (tan)	CC-2	\$84.95 ^{EA}
Light duty (gray)	CC-2	\$84.95 ^{EA}

CAR COVER ANTENNA GROMMET



This grommet snaps together and prevents the car cover from tearing at the antenna.

Year	Description	Part No.	List
All	White nylon	CC-AG	\$2.49 ^{EA}

CAR COVER CABLE WITH LOCK



Year all car covers. Durable, multi-strand cable with padlock. Helps prevent theft as well as keeps your cover in place on windy days.

Part No.	List
CC-CL	\$10.95 ^{SE}

TIRE PRESSURE GAUGE

Quality tire pressure gauge. Chrome plated with black painted rear case. 0 - 60 pounds per inch. Convenient reset button, each is packaged in hinged plastic storage case. Features white face with black numbers, letters and colored logo.



TG-2

List
\$18.95^{EA}



HEADLIGHT ASSEMBLY GILL TRIM



Plastic injection molded. This is an accessory item available in the mid sixties.

Year	Description	Part No.	List
64-66	Chrome	ACC-610-C	\$34.95 ^{PR}
64-66	Gold	ACC-610-G	\$34.95 ^{PR}

DOOR EDGE GUARD



Protects paint, made from rust resistant stainless steel.

Year	Part No.	List
64-66	C5ZZ-6520910/1	\$20.95 ^{PR}
67-68	C7ZZ-6520910/1	\$20.95 ^{PR}
69-70	C9ZZ-6520910/1	\$20.95 ^{PR}
71-73	D1ZZ-6520910/1	\$20.95 ^{PR}

FRONT SPOILER



Vacuumed formed impact resistant plastic with textured surface.

Year	Part No.	List
64-66	C5ZZ-63001A74-A	\$109.95 ^{EA}
67-68	C7ZZ-63001A74-A	\$109.95 ^{EA}
69	C9ZZ-63001A74-A	\$84.95 ^{EA}
70	D0ZZ-63001A74-A	\$84.95 ^{EA}
71-73	D1ZZ-63001A74-A	\$84.95 ^{EA}

REAR SPOILER



This wing will not sag like the original. Finished smooth with dull Black paint. Complete kit includes Spoiler, pedestals, pads & mounting hardware. Don't forget prop rod.

Year	Part No.	List
69-70	C9ZZ-6344210-K	\$174.95 ^{SE}
71-73	D1ZZ-6344210-K	\$174.95 ^{SE}

See the end of our "Sheet Metal & Body" section for Rear Spoiler mounting Hardware.

LUGGAGE RACK



This is a replica of the original Ford accessory luggage rack. It's stylish and functional addition to any classic Mustang. Features bight stainless steel construction for maximum corrosion protection.

Part No.	List
C5ZZ-655100-F	\$194.95 ^{KI}

MUSTANG PARTS TAG



Vintage style "mustang" parts tags with wire. Great for swap meets or just keeping track of your own parts.

Description	Part No.	List
With wire, bundles of 100	ACC-200*	\$8.00 ^{SE}



WE PROUDLY FEATURE AUTHENTIC MUSTANG REPRODUCTIONS FROM SCOTT DRAKE!



FUN STUFF

MUSTANG COOKIES



Locally baked. Classic cookies baked in the shape of Mustangs and Thunderbirds. Premium flavor and taste, made with all natural flavors, low sodium and low fat.



Desc.	Part No.	List
Small box	14954	\$2.50 EA

MUSTANG MAGNETIC SIGN

Look, But Please Don't Touch.. Car Show Signs. 3" x 5.25"



MM-1

List

\$4.95 EA



MM-2

List

\$4.95 EA



MM-3

List

\$4.95 EA

HATS

These high quality embroidered hats make the perfect gift!



HAT-183-BONE

List

\$16.95 EA



HAT-197-BLACK

List

\$16.95 EA



Pink, running horse & tri-bar
HAT-197-PINK

List

\$16.95 EA



HAT-F-BK/SF

List

\$17.95 EA



HAT-F-BK/YF

List

\$17.95 EA



HAT-F-BLK

List

\$17.95 EA



HAT-M-B/K

List

\$15.95 EA



HAT-M-BK/SIL

List

\$15.95 EA



HAT-M-BLK

List

\$15.95 EA



HAT-R-BLK

List

\$15.95 EA

OFFICIAL DRAKE AUTOMOTIVE HAT

From Drake is the Official DAG Logo Tru-Fit Hat (black). Classic baseball cap style, with embroidered 2 color DAG logo on front.



Description	Part No.	List
Tru-Fit (Large-EX-Large)	HAT-BK-DAG-LXLG	\$13.95 EA
Tru-Fit (Small-Medium)	HAT-BK-DAG-SMMD	\$13.95 EA

FEATURED ITEM

FIRE EXTINGUISHER & LIGHT MOUNT



ALUMINUM

NHRA approved, the Drake fire extinguisher mount is machined from 6061-T6 billet aluminum with a black anodized finish and laser etched logo. Features also include a red anodized quick release knob and versatile mounting options. Year various sizes of automobile fire extinguishers



Description	Part No.	List
Black	FIREX-MNT-DAG	\$64.95 EA
Silver	FIREX-MNT-DAG-5	\$64.95 EA

*Clamps sold separately (below). Fire Extinguisher not included.



This universal Flash Light Mount is machined from 6061-T6 billet aluminum with a black anodized finish to match our popular Fire Extinguisher Mount part # FIREX-MNT-DAG. Features include a red anodized quick release knob and versatile mounting options. This mount has been engineered to accept the most popular Flashlights.

Description	Part No.	List
Mount	LIGHT-MNT-DOR	\$64.95 EA

FIRE EXTINGUISHER MOUNT CLAMPS



Heavy Duty T-Bar style band clamps. Each set comes with 4 clamps: 2 for securing your fire extinguisher to our Drake Fire Extinguisher Mount (FIREX-MNT-DAG), and 2 for securing the mount to a roll bar in your vehicle. These clamps fit MaxOut fire extinguishers (MX100R or MX250R).

Description	Part No.	List
Large	FIRE-CLMP-L-DAG	\$18.95 SET
Small	FIRE-CLMP-S-DAG	\$18.95 SET

FIRE EXTINGUISHER MOUNT



New from Scott Drake is our 1965-68 Mustang Fire Extinguisher Mount Bracket. This part was developed to be used

in conjunction with our popular Billet Fire Extinguisher Mount (FIREX-MNT-DAG). This heavy duty tube steel bracket with semi-gloss powdercoat finish securely mounts under the front seat to the cars floor. Part includes high quality stainless steel hardware.

Year	Part No.	List
65-68	CSZZ-6520910/1	\$20.95 ^{EA}

SHIRTS

MUSTANG RACE BRED AND TRUE HORSES T-SHIRT



Quality shirts with brilliant silkscreened designs on both front and back. Our sweatshirts are made of 50% cotton/50% polyester.



Description	Part No.	List
Small	TS-2S*	\$15.95 ^{EA}
Medium	TS-2M*	\$15.95 ^{EA}
Large	TS-2L*	\$15.95 ^{EA}
XL	TS-2XL*	\$15.95 ^{EA}
XXL	TS-2XXL*	\$17.95 ^{EA}
XXXL	TS-2XXXL*	\$19.95 ^{EA}

MUSTANG EVOLUTION T-SHIRT



Hanes® comfort T with bright full color graphics. preshrunk 100% cotton.



Description	Part No.	List
Small	TS-E-S*	\$15.95 ^{EA}
Medium	TS-E-M*	\$15.95 ^{EA}
Large	TS-E-L*	\$15.95 ^{EA}
XL	TS-E-XL*	\$15.95 ^{EA}
XXL	TS-E-XXL*	\$17.95 ^{EA}
XXXL	TS-E-XXXL*	\$18.95 ^{EA}

67-68 MUSTANG T-SHIRT



Officially licensed by Ford This shirt features 3 views of the 67/68 Mustang and running horse logo.



Description	Part No.	List
Large	TS-6768-L*	\$17.95 ^{EA}
XL	TS-6768-XL*	\$17.95 ^{EA}
XXL	TS-6768-XXL*	\$17.95 ^{EA}

MUSTANG CLASSIC FORD T-SHIRT



Quality shirts with brilliant silk screened designs on both front and back. Made of 100% cotton.



Description	Part No.	List
Small	TS-3S*	\$15.95 ^{EA}
Medium	TS-3M*	\$15.95 ^{EA}
Large	TS-3L*	\$15.95 ^{EA}
XL	TS-3XL*	\$15.95 ^{EA}
XXL	TS-3XXL*	\$17.95 ^{EA}
XXXL	TS-3XXXL*	\$18.95 ^{EA}

WHO'S THE BOSS T-SHIRT



Officially licensed by Ford this shirt features 3 views of the Classic Mustang Boss and proudly boasts the question

“Whose The Boss?” As if we didn’t know the answer!



Description	Part No.	List
Medium	TS-FM-WTB-M*	\$17.95 ^{EA}
Large	TS-FM-WTB-L*	\$17.95 ^{EA}
XL	TS-FM-WTB-XL*	\$17.95 ^{EA}
XXL	TS-FM-WTB-XXL	\$19.95 ^{EA}

WOMEN'S PURE BRED GIRL T-SHIRT



We haven’t forgotten the ladies. This 100% cotton t-shirt will be perfect for those hot car shows coming up.



Description	Part No.	List
Small	TS-S-PB*	\$16.95 ^{EA}
Medium	TS-M-PB*	\$16.95 ^{EA}
Large	TS-L-PB*	\$16.95 ^{EA}

YOUTH / INFANT BORN 2 CRUZ T-SHIRT



Quality 100% cotton with beautiful full-color artwork. A must for every child & grandchild of a Mustanger.



Description	Part No.	List
Snap Shirt, 12 mo	B2C-12M*	\$19.95 ^{EA}
Snap Shirt, 24 mo	B2C-24M*	\$19.95 ^{EA}
Toddler, 2T	B2C-2T*	\$13.95 ^{EA}
Toddler, 4T	B2C-4T*	\$13.95 ^{EA}
Toddler, 6/8T	B2C-6/8T*	\$13.95 ^{EA}
Toddler, 10/12T	B2C-10/12T*	\$13.95 ^{EA}
Toddler, 14/16T	B2C-14/16T*	\$13.95 ^{EA}

YOUTH GROW UP FORD T-SHIRT



Classic “When I grow up I’m gonna drive a Ford “ logo on a quality Tee Shirt



Description	Part No.	List
Kids, 2T	TS-2T*	\$13.95 ^{EA}
Kids, 4T	TS-4T*	\$13.95 ^{EA}
Kids, 6/8T	TS-68T*	\$13.95 ^{EA}
Kids, 10/12T	TS-1012T*	\$13.95 ^{EA}

MUSTANG EVOLUTION T-SHIRT



Hanes® From Drake is the Official Drake Automotive Group Logo T-Shirt. This quality “T” boasts the

familiar two color DAG corporate logo screened on the front left breast. The verso sports the large DAG logo with the SD logo, DMC logo and DOR logo with the www. DrakeAutomotiveGroup.com web address. Great for all occasions and pair it up with the official DAG logo cap to make the set

Description	Part No.	List
Small (Black)	TS-DAG-BK-S	\$15.95 ^{EA}
Medium (Black)	TS-DAG-BK-M	\$15.95 ^{EA}
Large (Black)	TS-DAG-BK-L	\$15.95 ^{EA}
XL (Black)	TS-DAG-BK-XL	\$15.95 ^{EA}
XXL (Black)	TS-DAG-BK-XXL	\$15.95 ^{EA}
XXXL (Black)	TS-DAG-BK-XXXL	\$16.95 ^{EA}
Small (Gray)	TS-DAG-GY-S	\$15.95 ^{EA}
Medium (Gray)	TS-DAG-GY-M	\$15.95 ^{EA}
Large (Gray)	TS-DAG-GY-L	\$15.95 ^{EA}
XL (Gray)	TS-DAG-GY-XL	\$15.95 ^{EA}
XXL (Gray)	TS-DAG-GY-XXL	\$15.95 ^{EA}
XXXL (Gray)	TS-DAG-GY-XXXL	\$16.95 ^{EA}

CHROME/BRUSHED KEY CHAIN

Very nicely chrome-plated key chains with official logos.



Description	Part No.	List
Running horse & tri-bar	ACC-1033100	\$19.95 ^{EA}
Boss 302	ACC-1033108	\$19.95 ^{EA}
California Special	ACC-1033114	\$19.95 ^{EA}
Cobra	ACC-1033205	\$19.95 ^{EA}
Running horse and Mustang script	ACC-1033270	\$19.95 ^{EA}
Mustang GT	ACC-1033275	\$19.95 ^{EA}

WE PROUDLY FEATURE AUTHENTIC MUSTANG REPRODUCTIONS FROM SCOTT DRAKE!



FEATURED ITEM



Our Genuine Black Leather KeyFob is designed to accept anyone of our 7 exciting adhesive backed highly detailed multi-colored silkscreened and formed (raised) Aluminum Emblems. This greatly allows you stock more styles while reducing your overall Inventory Costs. These 1" emblems can be stuck anywhere on the car to accessorize including Corso Feroce Steering Wheels. All Emblems are licensed by Ford or Shelby.



Description	Part No.	List
Leather Fob	ACC-KEYFOB	\$3.25 ^{EA}
Ford Emblem	ACC-FORD-EMB	\$4.25 ^{EA}
Mustang Emblem	ACC-MUSTANG-EMB	\$4.25 ^{EA}
Shelby CS Emblem	ACC-CS-EMB	\$4.25 ^{EA}
Shelby Tiffany Snake Emblem	ACC-TIFFANY-EMB	\$4.25 ^{EA}
Bronco Emblem	ACC-BRONCO-EMB	\$4.25 ^{EA}
Cougar Emblem	ACC-COUGAR-EMB	\$4.25 ^{EA}
Falcon Emblem	ACC-FALCON-EMB	\$4.25 ^{EA}
Classic Cobra Emblem	ACC-COBRA-EMB	\$4.25 ^{EA}

AUDIO

ANTENNAS

1964-68 ANTENNA



Made by Scott Drake, this antenna is an exact match to the original. Includes everything needed for a trouble free installation: Mast, Chrome

Base, Chrome Mounting Bezel, Base Grommet, Lead Grommet, and Lead Wire Connector Plug.

Year	Description	Part No.	List
64-68	Reproduction, exact copy	C5ZZ-18813-B	\$17.50 ^{EA}

1964-68 BILLET ANTENNA



By Drake are these 1964-1968 Mustang Billet Antennas. Scott Drake designed these modern 8" Antennas. Our new short antennas finish is clear anodized and machined from 6061-T6 billet aluminum. Note: Must reuse original wedge from stock antenna or it can be purchased separately under part # C5ZZ-18A915-A if needed.

Year	Description	Part No.	List
64-Early 68	Billet Antenna	C5ZZ-18813-BL	\$29.95 ^{EA}

1968-73 BILLET ANTENNA



By Drake are these 1964-1973 Mustang Billet Antennas. Scott Drake designed these modern 8" Antennas. Our new short antennas

finish is clear anodized and machined from 6061-T6 billet aluminum. Note: Must reuse original wedge from stock antenna or it can be purchased separately under part # C5ZZ-18A915-A if needed.

Year	Description	Part No.	List
68-73	Billet Antenna	C8ZZ-18813-BL	\$29.95 ^{EA}

ANTENNAS

Each antenna offers excellent quality and supreme performance.



68-73
Not exact, similar to original, rectangular base
C8ZZ-18813-AR

List
\$19.95 ^{EA}



69-70
Concours rectangular base round shaped mast photo for reference. See website for correct picture.
C9ZZ-18813

List
\$79.95 ^{EA}

No Photo Available

Visit www.scottdrake.com for the most up to date images and product info



68-73
Antenna Extension Wire
C9ZZ-18813-EXT

List
\$5.95 ^{KI}

69-70
OEM Shelby
CSAZ-18813-J

List
\$121.95 ^{EA}



64-73
Universal power antenna
S-698

List
\$84.95 ^{KI}

RADIOS

USA-1 RADIO



From Custom Autosound, the USA-1 radio fits in the original dash without cutting, and features an attractive bezel with raised Mustang script. Features include: AM/FM, auto reverse cassette, and an auxiliary input for iPod, MP3, satellite radios, etc.

Year	Description	Part No.	List
64-66	Black	USA-1-5B*	\$207.95 ^{EA}
64-66	Chrome	USA-1-5C*	\$216.95 ^{EA}
67-73	Black	USA-1-7B*	\$207.95 ^{EA}
67-73	Chrome	USA-1-7C*	\$216.95 ^{EA}

USA-2 RADIO



From Custom Autosound, the USA-2 radio fits in the original dash without cutting, and features an attractive bezel with raised Mustang script. All the same features as our USA-1 except no cassette.

Mustang script. All the same features as our USA-1 except no cassette.

Year	Description	Part No.	List
64-66	Chrome	USA-2-5C*	\$169.00 ^{EA}
67-73	Chrome	USA-2-7C*	\$169.00 ^{EA}

USA-6 RADIO



From Custom Autosound, the USA-6 radio fits in the original dash without cutting, and features an attractive bezel with raised Mustang script. All the same features as our USA-5 except this radio features auxiliary input for iPod, MP3, satellite radios, etc. and no cassette.

Year	Description	Part No.	List
64-66	Chrome	USA-6-5C*	\$229.95 ^{EA}
67-73	Chrome	USA-6-7C*	\$229.95 ^{EA}

IPOD STEREO ADAPTER



Allows you to listen to your Ipod through your compatible car stereo. Use with USA-1, USA-6 or USA-66.

Year	Description	Part No.	List
64-73	Adapter	ICAMKIT	\$119.00 ^{EA}

USB FLASH STEREO ADAPTER



Allows for hook-up of any device with a USB port to a compatible car stereo.

Year	Description	Part No.	List
64-73	USB	CAM-USB-FLASH	\$139. ⁰⁰ EA

RADIO KNOB AND DIAL SET



Pressure die cast construction. Not cheap light weight plastic. Chrome plated and concurs correct. For use on original Ford radios.

Year	Part No.	List
64-66	C4AZ-18817/30-A	\$19. ⁹⁵ SE
69-70	C9ZZ-18817-K	\$45. ⁹⁵ SE
67	C7GY-18817-K	\$48. ⁹⁵ SE

DASH PANEL REPAIR PLATE



For that previously hacked radio installation, this panel provides a new dashboard section for installation of a stock radio and an original look. Can be welded into position. Designed to fit under dash pad.

Year	Part No.	List
64-66	CSZZ-6504360-PP	\$29. ⁹⁵ EA

RADIO BEZELS



67-68
Black/chrome, w/out console
C8ZZ-18842-AR

List
\$59.⁹⁵ EA



69-70
Black/chrome
C9ZZ-6504774-B

List
\$32.⁹⁵ EA



69-70
Walnut woodgrain
C9ZZ-6504774-F

List
\$44.⁹⁵ EA



71-73
Black/chrome
D1ZZ-18842-A

List
\$84.⁹⁵ EA

SPEAKERS

SPEAKER

High quality speakers, ranging from stock (OEM) style to multi-cone stereo models for terrific sound quality.



64-73
Hidden, under/behind seat, 200 watts
ACC-18808-S

List
\$119.⁹⁵ PR



64-73
Hidden, two 8" woofers,, rear seat, Custom Autosound
BSD-65-C

List
\$239.⁹⁵ EA



64-73
Dash, OEM style replacement
C5AZ-18808-A

List
\$19.⁹⁵ EA



64-66
Dash, dual voice coil by Custom Autosound, 140 watts
C5AZ-18808-DVC

List
\$44.⁹⁵ EA



64-66
Dash, dual by Kenwood, 40 watts
C5AZ-18808-KEN

List
\$74.⁹⁵ EA



64-66
Dash, 3" dual cone by Custom Autosound, 60 watts
C5AZ-18808-ST

List
\$33.⁹⁵ EA



65-68
Rear, 6"x9" stock replacement
C5ZZ-18808-R

List
\$21.⁹⁵ EA



67-68
Dash, 5"x7" OEM style replacement
C7AZ-18808-C

List
\$16.⁹⁵ EA



67-68
Dash, 5"x7" upgrade dual cone OEM style replacement, stock radios only
C7AZ-18808-D

List
\$19.⁹⁵ EA



67-68
Dash, 5"x7" co-axial, 60 watts. W/out AC
C7AZ-18808-DLX

List
\$49.⁹⁵ EA



67-68
Dash, Dual voice coil by Custom Autosound, 140 watts, w/out AC only
C7AZ-18808-DVC

List
\$44.⁹⁵ EA



67-73
5"x7" upgrade dual voice coil by Custom Autosound, 140 watts, w/ AC
C7AZ-18808-DVCA

List
\$58.⁹⁵ EA



67-68
Dash, 3" dual cone by Custom Autosound, 60 watts, w/out AC only
C7AZ-18808-ST

List
\$33.⁹⁵ EA



65-66
Door, 4"x6"
C6ZZ-18808-A

List
\$28.⁹⁵ EA



69-73
Door, 4"x6"
C9ZZ-18808-A

List
\$49.⁹⁵ PR

DOOR SPEAKER GRILLES

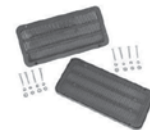

65-66
C6ZZ-18798-A

List
\$50.⁹⁵ PR

WE PROUDLY FEATURE AUTHENTIC MUSTANG REPRODUCTIONS FROM SCOTT DRAKE!





69-70
Stereo script
C9ZZ-18798-A

List
\$44.95 PR



71-73
D2ZZ-18978-A

List
\$29.95 EA

1967-68 DOOR SPEAKER GRILLES



Made by Scott Drake, these 1967-68 Deluxe Door Speaker Grilles are a beautiful reproduction. They can also be installed on 1965-66 doors for a custom look. Use our Door Grille Mounting Kit (C7ZN-3301) for proper installation on doors originally equipped with these grilles.

Year	Description	Part No.	List
67-68	Deluxe, also fits 65-66 for a custom look	C7Z-6520956/7A	\$124.95 PR

MOLDED KICK PANEL SPEAKER



Want more sound without cutting or drilling your classic Mustang? These kickpanel speaker assemblies offer a “no modification” fit. Come fitted with Kenwood 6 1/2” 80 watt speakers, or Pioneer 6 1/2” 160 watt speakers. **See Interior section for stock replacement panels.**

Year	Description	Part No.	List
64-66	Kenwood, 80 watt, Coupe/Fastback	KMC-1	\$124.95 PR
64-66	Kenwood, 80 watt, Convertible	KMCV-1	\$124.95 PR
67-68	Kenwood, 80 watt, Coupe/Fastback	KMC-2	\$124.95 PR
67-68	Kenwood, 80 watt, Convertible	KMCV-2	\$124.95 PR
65-66	Pioneer, 160 watt, Coupe/Fastback	PIO-KMC-1	\$169.95 PR
64-66	Pioneer, 160 watt, Convertible	PIO-KMCV-1	\$169.95 PR
67-68	Pioneer, 160 watt, Coupe/Fastback	PIO-KMC-2	\$169.95 PR
67-68	Pioneer, 160 watt, Convertible	PIO-KMCV-2	\$169.95 PR

REAR SPEAKER GRILLE



A nice reproduction 6”x9” speaker grill. Features correct screen pattern and edge molding. Includes hardware. For Coupe Rear

Package Tray or 65-68 FB interior quarter panels.

Year	Part No.	List
65-68	C5ZZ-18798-A	\$46.95 EA

TRAP DOOR WITH SPEAKER PODS



Made from sturdy ABS plastic these trap doors feature raised pad for easy installation of any 6x9 speaker. Economical way to replace your missing trap door or to save your original un-cut door.

Year	Part No.	List
65-66	C5ZZ-6345728-SP	\$149.95 EA
67-70	C7Z-6345728-SP	\$149.95 EA

PACKAGE TRAY WITH SPEAKER PADS



Molded from sturdy ABS plastic these feature 6”x9” speaker pads tilted forward for better sound. Eliminates the need to cut metal package tray framework.

Year	Description	Part No.	List
64-67	Coupe, w/ speaker pads	C5ZZ-6546656-SP	\$89.95 EA
68	Coupe, w/ speaker pads	C8ZZ-6546656-SP	\$89.95 EA
69-70	Coupe, w/ speaker pads	C9ZZ-6546656-SP	\$89.95 EA
69-70	Fastback, w/ speaker pads	C9ZZ-6346656-SP	\$159.95 EA

BRAKES

BRAKE CONVERSION KIT

FRONT DISC BRAKE CONVERSION KIT

Works great with our Power Brake Conversion. All new parts. No core required. These kits do not include a master cylinder or proportioning valve. Depending on year and application, proportioning valve and/or distribution block may be required. These kits do not include instructions and should be installed by someone familiar with basic brake systems.

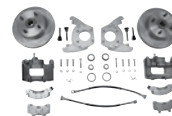

64-66
6 cylinder, original 4 lug, single piston calipers, will not fit original 14”x5” rims
DBC-6466-6

List
\$799.95 KT

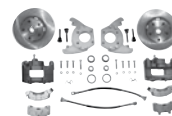

64-66
6 cylinder, 5 lug, single piston calipers, will not fit original 14”x5” standard steel rims
DBC-6466-6-5LUG

List
\$799.95 KT



64-66
V8, 4 piston calipers, will not fit original 14”x5” standard steel rims
DBC-6569

List
\$874.95 KT

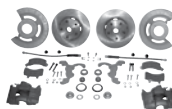

64-66
V8, single piston calipers, will not fit original 14”x5” standard steel rims
DBC-6569-5C

List
\$699.95 KT



65-69
V8, hi-po slotted rotors, single piston calipers, will not fit original 14”x5” standard steel rims
DBC-6569-RACE

List
\$809.95 KT

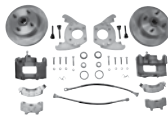

67-69
6 Cylinder, 4 lug, single piston
calipers, will not fit original
14"x5" standard steel rims
DBC-6769-6



List
\$799⁹⁵ KI



64-73
Big Brake Kit, 5 lug, 4-piston
calipers, slotted & drilled rotors,
requires 17" wheels
DBC-6573-BBK17



List
\$1,299⁹⁵ KI

FRONT MANUAL DISC BRAKE CONVERSION KIT WITH MASTER CYLINDER

These kits includes everything necessary to completely convert a production drum-brake equipped car to factory disc brakes, including proportioning valve and master cylinder. These will not fit standard stock rims.



64-66
6 cylinder, non-power
DBC-A120-4



List
\$1,049⁹⁵ KI



64-66
8 cylinder, dual master cylinder
DBC-A120-D



List
\$1,149⁹⁵ KI



64-66
8 cylinder manual brakes, single
reservoir master Cylinder, OE
Design
DBC-A120



List
\$1,074⁹⁵ KI



65-69
Force 10 4-piston aluminum
calipers, slotted rotors
DBC-A120-2



List
\$1,499⁹⁹ KI



67-69
8 cylinder, non-power
DBC-A121



List
\$1,209⁹⁵ KI



68-69
8 cylinder, non-power
DBC-A132-1



List
\$1,209⁹⁵ KI



70-73
Force 10 4-piston aluminum
calipers, bolts to drum brake
spindles
DBC-A133-3



List
\$1,349⁹⁵ KI



70-73
Cast Iron 4 piston, manual or
power brakes, bolts to drum
brake spindles
DBC-A133-2



List
\$1,149⁹⁵ KI

FRONT POWER DISC BRAKE CONVERSION KIT WITH MASTER CYLINDER

These kits includes everything necessary to completely convert a production drum-brake equipped car to factory disc brakes, including proportioning valve and master cylinder. These will not fit standard stock rims.



64-66
V8, 4 piston, non-slotted rotors,
Power, automatic only
DBC-A120-P



List
\$1,299⁹⁵ KI



64-66
6 cylinder, dual master cylinder,
Power, automatic only
DBC-A120-5



List
\$1,174⁹⁵ KI



67-69
Automatic, Power
DBC-A121-1



List
\$1,449⁹⁵ KI



68-69
Automatic, Power
DBC-A132-A



List
\$1,490⁹⁵ EA



68-69
Manual, Power
DBC-A132-M



List
\$1,349⁹⁵ EA



70
Cast iron single piston,
Power, includes new disc brake
spindles
DBC-A133



List
\$1,349⁹⁵ KI



71-73
Automatic, Power
DBC-A134



List
\$1,524⁹⁵ KI

WILWOOD DISC BRAKE CONVERSION KIT



Designed specifically for the five lug first generation Mustang. Designed to fit many popular stock 14.00" steel and aluminum wheels. 11.30" diameter vented plain face or by special order drilled and slotted rotors. Install on both OE drum and disc brake spindles. Forged Dynalite Calipers provide big clamping power in a truly lightweight, rigid and reliable design. Designed for optimal clearance. Black anodized. Rotors include bearings and seals. Kits include BP-10 metallic-composite compound "Smart Pads". BP-10 delivers the increased friction; higher fade resistance and longer wear of an entry-level track pad, with virtually noise and dust free performance for the street. Caliper brackets, premium grade hardware and detailed installation instructions are included in every kit. Jacketed stainless steel braided DOT approved flex lines are included.



Year	Part No.	Description	List
64-69	DBC-6569-WW	W/ standard rotors	\$674 ⁹⁵ KI
64-69	DBC-6569-WW-DSR	W/ drilled & slot- ted rotors	\$774 ⁹⁵ KI

**WE PROUDLY FEATURE AUTHENTIC MUSTANG
REPRODUCTIONS FROM SCOTT DRAKE!**



REAR DISC BRAKE CONVERSION KIT

Your classic Mustang will stop even better with a Rear Disc Brake Conversion Kit. Every kit includes full feature calipers with parking brake, splash shields, flex hoses and all the necessary hardware to install disc brakes on your 8" or 9" Ford axle.



64-73
Standard duty, 28 spline rear axle
DBC-A111-2

List

\$709⁹⁵ KI



64-73
Super duty, 31 spline rear axle
DBC-A110

List

\$1,019²⁵ KI



64-73
Standard duty, 31 spline rear axle
DBC-A110-1

List

\$867⁹⁵ KI



64-73
Standard rotors, 28 spline
DBC-REAR

List

\$750⁰⁰ EA

Note: This kit requires a custom rear parking brake cable, available seperately



64-73
Drilled and slotted rotors
DBC-REAR-RACE

List

\$809⁹⁵ EA

Note: This kit requires a custom rear parking brake cable, available seperately

POWER ASSIST

DUAL CHAMBER POWER BRAKE CONVERSION KIT



This setup utilizes a new power brake booster with increased sensitivity, new large capacity dual

chamber master cylinder, specially designed mounting bracket to allow direct bolt in while retaining original brake pedal assembly and clearance of the shock tower. * Note: Booster requires a minimum 15 inches of engine vacuum pressure at idle for maximum stopping power. Some high performance high lift camshafts may not create enough vacuum. Stock engine vacuum pressure is 18 inches. 1 year warranty. Picture for reference only. Check website for actual picture of each kit. *(Note: PBC-M1 & PBC-M2 require notching factory shock tower brace. Export brace recommended.) Will not fit cars with factory power brakes. Installation instructions are not included, as this kit should be installed by a trained professional. We recommend part number PBC-MCL to ease installation. Early cars may also require a brake distribution block. **Note: Original Master Cylinders had Left Hand Ports, a few of the below kits have Right Hand (RH) ports as noted.**

Year	Description	Part No.	List
64-66	Disc, auto., cast iron M/C	PBC-A1	\$324 ⁹⁵ KI
64-66	Disc, auto., aluminum M/C w/ RH ports	PBC-A4	\$294 ⁹⁵ KT
64-66	Drum, auto., cast iron M/C	PBC-A2	\$324 ⁹⁵ KI
64-66	4 wheel disc brakes, auto., cast iron M/C	PBC-A1-4WDB	\$374 ⁹⁵ EA
64-66	4 wheel disc brakes, manual trans, billet M/C, RH ports	PBC-M1-4WDB	\$375 ⁹⁵ EA
64-66	Disc, manual trans	PBC-M1	\$374 ⁹⁵ KI
64-66	Drum, manual trans	PBC-M2	\$374 ⁹⁵ KI
64-66	Disc w/ 4 speed trans, aluminum M/C w/ plastic reservoir, RH ports	PBC-M1-ALUM-MC	\$374 ⁹⁵ KI
64-66	Manual, w/ billet M/C	PBC-M4	\$419 ⁹⁵ EA
67-70	Disc Brakes, auto trans	PBC-67-1	\$329 ⁹⁵ EA
67-70	Drum brakes, auto trans	PBC-67-2	\$329 ⁹⁵ EA
67-70	Disc brakes, manual trans	PBC-67-3	\$329 ⁹⁵ EA
67-70	Drum brakes, manual trans	PBC-67-4	\$329 ⁹⁵ EA
67-70	4 wheel disc brakes, automatic	PBC-67-4WDB	\$329 ⁹⁵ EA

7" POWER BRAKE BOOSTER & DUAL MASTER CYLINDER



Compliment to the 65-66 drum to disc conversions. Greatly increases your stopping power. Includes 7" booster and dual master cylinder. Note: For automatic cars only. Features adjustable push rod.

Year	Part No.	List
64-66	DBC-A28143	\$349 ⁹⁵ EA

POWER BRAKE CONVERSION LINE & FITTING KIT



This kit includes two straight lines (15" and 18") with the correct double flare on one end and fittings for the master cylinder. We

have included extra fittings to accommodate most cars. Although this kit is intended for the trained professional installing our conversion kits, customers with the correct flaring and bending tools will find this kit convenient to use and a time saver.

Year	Description	Part No.	List
65-73	Year all dual chamber master cylinders	PBC-MCL	\$20 ⁹⁵ KI

SINGLE CHAMBER POWER BRAKE CONVERSION KIT



Single chamber master cylinder Power Brake Conversion. Perfect for customers looking for a more original appearance

or a simpler installation. Uses stock manual brake pedal.

Year	Description	Part No.	List
64-66	Drum brakes w/ auto trans	PPBC-A3	\$319 ⁹⁵ EA
64-66	Drum brakes w/ man trans	PBC-M3	\$374 ⁹⁵ EA

ORIGINAL STYLE BRAKE BOOSTER WITH DISC BRAKE MC



This original Bendix Style Booster is a direct replacement for 67-69 Cars with original Power Disc Brakes. Will also replace Midland Style

Boosters as well. Can only be used with Power Brake Pedals, not compatible with Manual Brake Pedals. If you wish to run this Booster set-Up on a Manual Brake car then you must order appropriate Power Brake Pedal as well. Will not Fit 1970.

Year	Part No.	List
67-69	C7ZZ-2005/2140	\$349.95 ^{SE}

ORIGINAL-STYLE REPLACEMENT POWER BRAKE BOOSTER



Bendix style replacement boosters. 8" Dual diaphragm. Will only fit onto original power brake pedals.

Year	Part No.	List
67-69	C7ZZ-2005-BDX	\$284.95 ^{EA}
70	DOZZ-2005-BDX	\$284.95 ^{EA}

DISC BRAKE PROPORTIONING VALVE



This aftermarket proportioning valve is far superior to the original equipment. Fully adjustable for tuning

front to rear brake bias. Requires some routing modifications of brake lines for proper fit. Includes adapter fittings

Year	Part No.	List
64-73	CSZZ-2B091-R	\$62.95 ^{EA}

DISTRIBUTION BLOCK WITH PROPORTIONING VALVE



Adjustable proportioning valve and distribution block all-in-one. Simplifies your brake plumbing! Available in a black

anodized or polished finish. Accepts 3/16" brake line. Adjustable proportioning valve regulates rear brake pressure, helping to maintain correct brake bias between front and rear brakes. Easy to turn handle with directional arrows makes it simple to either increase or decrease rear brake pressure. Designed for dual bowl master cylinders. Distribution block connects to the master cylinder and distributes brake fluid to all four wheels. Includes 2 inlets from master cylinder, 2 outlets to front brakes and 1 outlet to rear brakes. Includes 5 stainless steel 3/16" fittings. Includes wiring pigtail for rear brake light switch. Mount to any convenient location. *NOTE: This is not a direct factory replacement for original blocks and some line modifications may be necessary.

Year	Description	Part No.	List
64-73	Black anodized	A0730	\$124.95 ^{EA}
64-73	Polished	A0730P	\$149.95 ^{EA}

PROPORTIONING VALVE REBUILD KIT

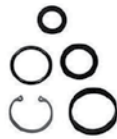

KIT

Rebuild your proportioning valve and stop leaks. Kit includes 4 seals and retaining ring. Note: Ford had two versions, externally identical but internally

different. This kit fits the early version. Not returnable if opened.

Year	Part No.	List
65-66	CSZZ-2B091-K	\$24.95 ^{KI}

BRAKE DISTRIBUTION BLOCK



These are late model units that are not direct replacements and will require bending brake lines. Highly recommend when converting

64-66 over to dual chamber master cylinder. DOZZ version is the same except the bracket is reverse so it is more compatible with original 1970 PDB cars.

Year	Description	Part No.	List
64-73	Aftermarket	DOZZ-2B257-A	\$89.95 ^{EA}
70	Aftermarket	DOZZ-2B257-A	\$89.95 ^{EA}

BRAKE PRESSURE SWITCH



This switch mounts on the brake junction block to warn the driver of potential brake failure through a warning light on the dash. Won't fit early 67 Mustangs with 1 contact pin.

Year	Part No.	List
Late 67-69	C8AZ-2B264-A	\$21.95 ^{EA}

POWER BRAKE BOOSTER VACUUM LINE



Screws into intake manifold fitting and runs to rubber hose from power booster. Quality construction.

Year	Description	Part No.	List
68-69	302, 351	MVB001	\$18.00 ^{EA}
68-69	302, 351 stainless	MVB001S	\$22.00 ^{EA}
64-65	260, 289	MVB002	\$18.00 ^{EA}
64-65	260, 289 stainless	MVB002S	\$22.00 ^{EA}
68-69	428	MVB003	\$18.00 ^{EA}
68-69	428, stainless	MVB003S	\$22.00 ^{EA}
68-69	428 Shelby	MVB004	\$18.00 ^{EA}
68-69	428 Shelby, stainless	MVB004S	\$22.00 ^{EA}

POWER BOOSTER BRAKE LINE KIT



Factory Power Booster Brake Line

Year	Description	Part No.	List
66	Steel	MPL001	\$14.95 ^{EA}
66	Stainless	MPL001S	\$21.95 ^{EA}
64-65	Steel	MPL002	\$14.95 ^{EA}
64-65	Stainless	MPL002S	\$21.95 ^{EA}

DISC BRAKE MASTER CYLINDER



Includes new cap and diaphragm

Year	Description	Part No.	List
64-66	Manual disc brakes - Original	CSZZ-2140-CR	\$144.95 ^{EA}
64-73	Billet and polished, RH ports	CSZZ-2140-MB	\$129.95 ^{EA}
67-72	Power disc brakes	C8ZZ-2140-AR	\$74.95 ^{EA}
64-73	4 wheel disc brakes	C7ZZ-2140-4WDB	\$104.95 ^{EA}
72-73	Power disc brakes	D2ZZ-2140-AR	\$74.95 ^{EA}

WE PROUDLY FEATURE AUTHENTIC MUSTANG REPRODUCTIONS FROM SCOTT DRAKE!



DRUM BRAKE MASTER CYLINDER



Brand new units, not rebuilt. 1966 manual is obsolete, 64-65 will work. Brass adaptor may be required.

Year	Description	Part No.	List
64-65	Manual drum	C4AZ-2140-BR	\$69. ⁹⁵ EA
64-65	Power drum	C5ZZ-2140-BR	\$89. ⁹⁵ EA
66	Power drum	C6AZ-2140-BR	\$94. ⁹⁵ EA
67-70	Power drum	C7ZZ-2140-GR	\$99. ⁹⁵ EA
67-70	Manual drum	C9AZ-2140-DR	\$59. ⁹⁵ EA
72-73	Late 1972, manual drum	D2ZZ-2140-CR	\$104. ⁹⁵ EA

ELECTRIC HIGH PRESSURE MASTER CYLINDER



This polished aluminum master cylinder is the answer for Mustang owners with special brake needs. Lack of space because of a big

motor, lack of vacuum caused by big cams, blown or supercharged engines, or are you just looking for a superior looking unit that does not hang out so far from the firewall? This unit is a unique self-contained booster that is not dependent on engine vacuum booster or a steering pump, yet is capable of generating up to 2500 lbs of line pressure. It features a larger bore than most cylinders so it can handle single or multi-piston calipers, but still gives you a solid pedal.

Year	Part No.	List
64-73	PBC-EHPMC	\$1,424. ⁹⁵ KT

MASTER CYLINDER PUSHROD BUSHING



Made of black ABS. Required to reduce brake pedal slop and eliminate noise from metal on metal when applying brakes.

Year	Part No.	List
65-69	C5DZ-2474-A	\$2. ⁷⁵ EA

MASTER CYLINDER ADJUSTABLE PUSH ROD



Multiple applications including used when brake booster is removed for non power brake application.

This rod may require alterations in some applications.

Year	Part No.	List
64-68	A21161	\$44. ⁹⁵ EA

ADJUSTABLE MANUAL DISC BRAKE PUSH ROD SET

This changes the pedal ratio so that the pedal does not go down as far before engaging the brakes, after you have converted to front manual disc brakes. This Kit is for Manual Disc Brake Conversions only. Will NOT work with Power Disc Brake Set-up.



Year	Part No.	List
64-68	A21161-DB	\$45. ⁹⁵ SE

PUSH ROD POWER BRAKE BOOSTER SEAL



Seals power brake booster push rod to firewall.

Year	Part No.	List
65-66	C5ZZ-2021	\$9. ⁹⁵ EA

BRAKE LINE PRESSURE GAUGE KIT



A perfect accessory for the disc brake proportioning valve. Monitor brake line pressure. Necessary to

diagnose brake systems.

Year	Description	Part No.	List
64-73	7 Piece kit	DBC-A1704	\$59. ⁹⁵ KT

MASTER CYLINDER BRAKE LINE KIT



Exact copies of the originals. Steel tubing features tin/lead coating

and plated zinc chromate finishing.

Year	Description	Part No.	List
64-65	Standard brakes	MML001	\$17. ⁹⁵ EA
64-65	Standard brakes, stainless	MML001S	\$19. ⁷⁵ EA
66	Standard brakes	MML002	\$14. ⁹⁵ EA
66	Standard brakes, stainless	MML002S	\$19. ⁷⁵ EA
65-66	GT disc brakes	MML003	\$14. ⁹⁵ EA
65-66	GT disc brakes, stainless	MML003S	\$19. ⁷⁵ EA
68-69	Standard brakes	MML004	\$14. ²⁵ EA
68-69	Standard brakes, stainless	MML004S	\$19. ⁷⁵ EA
68-69	Power disc brakes	MML005	\$14. ⁹⁵ EA
68-69	Power disc brakes, stainless	MML005S	\$19. ⁷⁵ EA
67	Power disc brakes	MML006	\$14. ⁹⁵ EA
67	Power disc brakes, stainless	MML006S	\$19. ⁷⁵ EA
67	Drum brakes only (before 2/1/67)	MML007	\$16. ⁹⁵ EA
67	Drum brakes only (before 2/1/67), stainless	MML007S	\$19. ⁷⁵ EA
71-73	Drum brakes only (after 2/1/67)	MML008	\$14. ⁹⁵ EA
71-73	Drum brakes only (after 2/1/67), stainless	MML008S	\$19. ⁷⁵ EA
71-73	Disc brakes (after 2/1/67)	MML009	\$14. ⁹⁵ EA
71-73	Disc brakes (after 2/1/67), stainless	MML009S	\$19. ⁷⁵ EA
69-70	Boss 429	MML010	\$14. ⁹⁵ EA
69-70	Boss 429, stainless	MML010S	\$19. ⁷⁵ EA
70	Power disc brakes only	MML011	\$14. ²⁵ EA
70	Power disc brakes, stainless	MML011S	\$19. ⁷⁵ EA
67	Disc brakes after 2-1-67	MML012	\$14. ⁹⁵ EA
67	Disc brakes after 2-1-67, stainless steel	MML012S	\$19. ⁷⁵ EA
67	Drum brakes after 2-1-67	MML013	\$14. ⁹⁵ EA
67	Drum brakes after 2-1-67, stainless steel	MML013S	\$21. ⁹⁵ EA
70	Drum brakes	MML014	\$13. ⁹⁵ EA
70	Drum brakes, stainless steel	MML014S	\$21. ⁹⁵ EA
64-65	Power drum brakes	MML015	\$14. ⁹⁵ EA
64-65	Power drum brakes, stainless steel	MML015S	\$17. ⁹⁵ EA
66	Power drum brakes	MML016	\$14. ⁹⁵ EA
66	Power drum brakes, stainless steel	MML016S	\$21. ⁹⁵ EA
67	Power drum brakes	MML017	\$14. ⁹⁵ EA
67	Power drum brakes, stainless steel	MML017S	\$21. ⁹⁵ EA
68-69	Power drum brakes	MML018	\$14. ⁹⁵ EA
68-69	Power drum brakes, stainless steel	MML018S	\$21. ⁹⁵ EA

DRUM BRAKE MASTER CYLINDER CAP



Made by Scott Drake. This cap features exact details in the lettering. Includes diaphragm, gold, silver or chrome. Our 64-66 cap

is also available in a machined 6061 billet version for a custom look.

Year	Description	Part No.	List
64-66	Drum brake, billet	B-2162-A	\$17.95 ^{EA}



Year	Description	Part No.	List
65-66	Drum brake, gold cadmium	CSZZ-2162-B	\$18.95 ^{EA}
64-66	Drum brake, silver zinc	CSZZ-2162-S	\$16.95 ^{EA}
64-66	Drum brake, chrome	CSZZ-2162-BC	\$19.95 ^{EA}

DRUM BRAKE MASTER CYLINDER CAP



Year	Description	Part No.	List
67-73	Cadium plated	D3AZ-2162-A	\$18.95 ^{SE}
67-73	Chrome	D3AZ-2162-C	\$19.95 ^{SE}

DISC BRAKE MASTER CYLINDER CAP



Now made by Scott Drake. Our caps feature exact letter stamping detail on top. Rubber diaphragm and bail wire included.

Available with a gold cadmium finish like original, or a chrome finish.

Year	Description	Part No.	List
64-66	Disc brake, zinc	CSZZ-2162-GZ	\$17.95 ^{EA}
64-66	Disc brake, Chrome	CSZZ-2162-DR	\$21.95 ^{EA}

DRUM BRAKE MASTER CYLINDER CAP



Year	Description	Part No.	List
67-73	Disc brake gold cadmium	D3AZ-2162-A	\$18.95 ^{SE}
67-73	Disc brake chrome	C7AZ-2162-CR	\$19.95 ^{SE}

MASTER CYLINDER CAP DIAPHRAGM



Year underneath master cylinder cap to prevent leaks.

Year	Description	Part No.	List
64-66	Disc brakes	CSZZ-2167-A	\$17.95 ^{EA}
67-73	Disc brakes	C7AZ-2167-A	\$17.95 ^{EA}
67-73	Drum brakes	C9AZ-2167-B	\$17.95 ^{EA}
70-73	Drum brake, manual	D3AZ-2167-B	\$17.95 ^{EA}

DISC BRAKE COMPONENTS

DISC BRAKE ROTOR



Excellent quality replacements. Includes hub, studs, and bearing races.

Year	Part No.	List
65-67	CSZZ-1102-BRI	\$84.95 ^{EA}
68-69	C80Z-1102-ARI	\$84.95 ^{EA}
70-73	D00Z-1102-BR	\$107.50 ^{EA}

TURBO ROTOR UPGRADE KIT



This kit includes SSBC turbo slotted rotors, high performance brake pads and any necessary hardware. bolts directly to stock spindles and calipers offering a low cost performance upgrade. Front brakes only.

SSBC
SHOCKING PERFORMERS

Year	Description	Part No.	List
65-67	Turbo slotted	DBC-A2360000	\$299.95 ^{KI}
68-69	Turbo slotted	DBC-A2360001	\$499.95 ^{KI}
70-73	Turbo slotted	DBC-A2360002	\$279.95 ^{KI}

DISC BRAKE DUST SHIELD



Year Stamped steel construction. Ready to install.

Year	Part No.	List
65-67	CSZZ-2K004/5-A	\$17.95 ^{PR}
68-73	C90Z-2K004/5-A	\$17.95 ^{PR}

DISC BRAKE PAD RETAINER PLATE

These retainers are designed to keep the disc brake pad inside the caliper on 1967 Mustangs. Can also be used on 1965/66 cars.



65-67
C70Z-2B164-A

List
\$18.95^{PR}



65-66
Stainless steel
CSZZ-2B127-A

List
\$29.95^{EA}

FRONT DISC BRAKE PADS



All new disc brake pads are supplied to us by brand name manufacturers for the

best in customer satisfaction. Boxed sets of four pads. Organic linings. Also available in semi-metallic.

Year	Description	Part No.	List
65-67		CSZZ-2018-BR	\$29.95 ^{SE}
65-67	Semi-metallic	CSZZ-2018-SM	\$39.95 ^{PR}
68-73		D00Z-2018-CR	\$30.95 ^{SE}
68-73	Semi-metallic	D00Z-2018-SM	\$40.95 ^{PR}
65-69	Race pads for -SC and -RACE DBC kits	CSZZ-2018-SC	\$29.95 ST

NEW DISC BRAKE CALIPER



No core charge. These are new calipers using quality parts. They feature new pistons, all new seals, new guide bolts, new

hardware and are 100% pressure tested. Pads are not included. Note: will fit 1967, but must purchase 65-66 hose and brake fitting adapters from your local auto parts store.

Year	Part No.	List
65-66	CSZZ-2B120/1-CR	\$299.95 ^{PR}

WE PROUDLY FEATURE AUTHENTIC MUSTANG REPRODUCTIONS FROM SCOTT DRAKE!



PREMIUM DISC BRAKE CALIPER



New cast-iron, front 4-piston calipers. These calipers are e-coated internally and externally for maximum corrosion resistance. Built

with stainless steel pistons, stainless steel bleeders, and stainless steel transfer tubes.

100% made in the USA!

Year	Description	Part No.	List
65-66	RH, 3/8" inlet	CSZZ-2B120-C	\$204. ⁹⁵ EA
65-66	LH, 3/8" inlet	CSZZ-2B121-C	\$204. ⁹⁵ EA
67	RH, 7/16" inlet	C7OZ-2B120-C	\$204. ⁹⁵ EA
67	LH, 7/16" inlet	C7OZ-2B121-C	\$204. ⁹⁵ EA

DISC BRAKE CALIPER CROSS OVER LINE



Precision made brake lines with correct fittings.

SSBC
BRAKING SOLUTIONS

Year	Description	Part No.	List
65-67	Stainless steel	MCL001S	\$22. ⁰⁰ PR

CALIPER DUST SEAL RETAINER



Steel retainer. One for each piston is required.

Year	Part No.	List
65-67	CSZZ-2A492-A	\$8. ²⁵ EA

CALIPER MOUNTING BRACKETS



Year	Description	Part No.	List
65-67	Mounting Bracket Set	CSZZ-2B134/5-B	\$94. ⁹⁵ PR

DISC BRAKE CALIPER PISTON



Quality chrome-plated steel construction.

Year	Part No.	Description	List
65-66	CSZZ-2196-A	Steel	\$16. ⁹⁵ EA

CALIPER REBUILD KIT

All necessary parts for overhauling disc brake calipers. Includes all new piston seals and dust boots. Each kit contains the parts for one caliper assembly.



65-67
One side only
CSZZ-2B120/1-K

List
\$22.⁹⁵ KI



68-73
One side only
C8ZZ-2B120/1-HK

List

\$25.⁹⁵ EA



68-73
One side only
C8ZZ-2B120/1-SK

List

\$11.⁹⁵ KI

DISC BRAKE HOSE



Original equipment style hoses feature Ford Spec fittings. Quality American made replacements. Front.

Year	Description	Part No.	List
64-66	Right hand or left hand	CSZZ-2078-AR	\$18. ⁹⁵ EA
67	Right hand or left hand	C7OZ-2078-BR	\$18. ⁹⁵ EA
68-70	Right hand	C8ZZ-2078-AR	\$35. ⁹⁵ EA
68-70	Left hand	C8ZZ-2078-BR	\$35. ⁹⁵ EA
71-73	Right hand	D1ZZ-2078-CR	\$39. ⁹⁵ EA
71-73	Left hand	D1ZZ-2078-DR	\$39. ⁹⁵ EA

DRUM BRAKE COMPONENTS

BRAKE DRUM



These new brake drums are perfect replacements for tired and thin originals. Front drums do not include studs or a hub.

Year	Description	Part No.	List
64-66	Front, 6 cylinder	C1DZ-1102-BR	\$72. ⁹⁵ EA
67-70	Front, 6 cylinder	C6OZ-1102-GR	\$74. ⁹⁵ EA
64-73	Rear, 6 cylinder	CODZ-1126-CR	\$59. ⁹⁵ EA
64-73	Rear, 8 cylinder 10"x1 3/4"	C3OZ-1126-BRI	\$74. ⁹⁵ EA
64-73	Rear, 10"x2"	C3OZ-1126-AR	\$84. ⁹⁵ EA

BRAKE HUB GREASE CAP



Stamped steel with gold dichromate finish.

Year	Description	Part No.	List
64-69	8 cylinder	B5A-1131-A	\$6. ⁹⁵ EA
64-66	6 cylinder	C3DZ-1131-A	\$10. ⁹⁵ EA

BRAKE SPRING AND HOLD DOWN KIT



These kits contain all the replacement springs and hold downs required to do a professional job on drum brakes. Kit includes enough parts for two wheels.

Year	Part No.	Description	List
64-73	CSZZ-2035-AK	Front 9"	\$14. ⁹⁵ KI
64-70	CSZZ-2035-BK	Rear 9"	\$15. ⁹⁵ KI
64-71	CSZZ-2035-CK	Front and rear 10"x2"	\$14. ⁹⁵ KI
64-71	CSZZ-2035-DK	Rear, 10"x1.75"	\$14. ⁹⁵ KI
64-73	D2ZZ-2035-EK	64-71 Front and 72-73 rear, 10"x2"	\$9. ⁹⁵ KI
72-73	D2ZZ-2035-FK	Rear, 10"x1.75"	\$9. ⁹⁵ KI

DRUM BRAKE HUB



A quality reproduction is now available. Studs not included. Drums only.

Year	Part No.	Description	List
64-66	C3DZ-1107-HUB	6 cylinder	\$84. ⁹⁵ EA
64-69	CSZZ-1107-HUB	8 cylinder	\$79. ⁹⁵ EA

DRUM BRAKE SHOES



These relined shoes have bonded linings made to original manufacturer's specifications. No core required. Sets of 4 shoes, front or rear.

Year	Part No.	Description	List
64-71	C7OZ-2001-BR	Front, V8 & 250 6-cyl sm block only	\$34. ⁹⁵ SE
64-70	C4DZ-2001-AR	Front, 6 cylinder	\$34. ⁹⁵ SE
67-73	C6OZ-2001-AR	Front, 351 and big block only	\$34. ⁹⁵ SE
64-73	C7ZZ-2200-AR	Rear, V8 & 250 6-cyl sm block only	\$34. ⁹⁵ SE
64-70	C4AZ-2001-AR	Rear, 6 cylinder, except convertible	\$34. ⁹⁵ SE
64-70	C4DZ-2001-AR	Rear, 6 cylinder, convertible only	\$34. ⁹⁵ SE
68-73	C6OZ-2200-AR	Rear, 351 and big block only	\$34. ⁹⁵ SE

FRONT WHEEL BEARING AND RACE



U.S. made quality bearings.

Year	Part No.	Description	List
64-69	B5A-1201-A	Inner, V8	\$16. ⁹⁵ EA
64-69	B5A-1216-A	Outer, V8	\$14. ⁵⁰ EA
64-66	C5ZZ-1201-A	Inner, 6 cylinder, drum brakes	\$14. ⁵⁰ EA
64-66	C5ZZ-1216-A	Outer, 6 cylinder, drum brakes	\$14. ⁵⁰ EA
70-73	D0ZZ-1201-A	Inner	\$18. ⁹⁵ EA
70-73	D0ZZ-1216-A	Outer	\$16. ⁹⁵ EA

INNER GREASE SEALS



High quality part made in the U.S.A.

Year	Part No.	Description	List
64-73	B5AZ-1190-A	Front Grease Seal (8 Cylinder)	\$6. ⁵⁰ EA

REAR WHEEL BEARING



High quality part made in the U.S.A.

Year	Part No.	Description	List
64-73	C5ZZ-1225-A	V8, 8 & 9 inch rear end, 28 spline	\$35. ⁹⁵ EA
65-70	C5ZZ-1225-B	6 cylinder, 24 spline	\$35. ⁹⁵ EA

SELF ADJUSTER REPAIR KIT



These kits contain all the parts necessary to refurbish the self adjusting mechanism on drum brakes. Includes new cable and guide, ratchet, spring, and all necessary small parts. Kits include everything for one wheel.

Year	Part No.	Description	List
64-70	C5ZZ-2041-AK	Right hand, 9"	\$14. ⁹⁵ KI
64-70	C5ZZ-2041-BK	Left hand, 9"	\$14. ⁹⁵ KI
64-73	C5ZZ-2041-CK	Right hand, 10"	\$16. ⁹⁵ KI
64-73	C5ZZ-2041-DK	Left hand, 10"	\$16. ⁹⁵ KI

FRONT DRUM WHEEL STUD



Name brand. Made in the U.S.A.

Year	Part No.	Description	List
64-66	C3AZ-1107-A	Front	\$3. ⁵⁰ EA
64-73	C5ZZ-1107-A	Rear	\$3. ⁵⁰ EA

REAR AXLE BACKING PLATE GAS-

KET



This gasket goes between the rear axle flange and the backing plate on the differential. There is also an outer gasket, part number C5ZZ-1001-O. They both fit all V8 Mustangs from 1964 through 1973.

Year	Part No.	Description	List
65-73	C5ZZ-1001-I	V8, Inner	\$4. ⁹⁵ EA
65-73	C5ZZ-1001-O	V8 -Outer	\$4. ⁹⁵ EA

DRUM BRAKE HOSE



These original style hoses feature factory specification fittings.

Year	Part No.	Description	List
64	B7AZ-2078-AR	Early 1964, front	\$19. ⁹⁵ EA
64-66	C5ZZ-2078-BR	Late 1964, front	\$16. ⁹⁵ EA
67-70	C7ZZ-2078-AR	Front	\$19. ⁹⁵ EA
71-73	D1ZZ-2078-ER	Front	\$28. ⁹⁵ EA

REAR BRAKE HOSE



Quality American made replacement hose assemblies for the rear brakes.

Year	Part No.	Description	List
64-66	C5ZZ-2282-AR	All except GT	\$27. ⁹⁵ EA
65-66	C5ZZ-2282-DR	GT or factory dual exhaust	\$44. ⁹⁵ EA
67-69	C7ZZ-2282-AR	All Except Boss and 428	\$32. ⁹⁵ EA
70	D0ZZ-2282-AR		\$44. ⁹⁵ EA
71-73	D1ZZ-2282-AR		\$44. ⁹⁵ EA

BRAKE AND FUEL LINE CLIP KIT



Convenient kit which mounts front to rear gas lines and long brake line. Kit includes all clips, fasteners and instructions.

Year	Part No.	List
64-67	380374-MK	\$15. ⁹⁵ SE

BRAKE WHEEL CYLINDER



All brand new, quality castings and parts.

Year	Part No.	Description	List
64	C3DZ-2261-AR	6 cyl., rear, right hand or left hand	\$31. ⁹⁵ EA
64-73	C30Z-2061-BR	V8, front, right hand	\$23. ⁹⁵ EA
64-73	C30Z-2062-BR	V8, front, left hand	\$23. ⁹⁵ EA
64-72	C30Z-2261-BR	V8, rear, right hand, 29/32"	\$23. ⁹⁵ EA
64-72	C30Z-2262-BR	V8, rear, left hand, 29/32"	\$23. ⁹⁵ EA
64-70	C5DZ-2061-AR	6 cyl., front, right hand	\$32. ⁵⁰ EA
64-70	C5DZ-2062-AR	6 cyl., front, left hand	\$32. ⁵⁰ EA
64-66	C5DZ-2261-AR	6 cyl., rear, right hand or left hand	\$34. ⁹⁵ EA
67-73	C60Z-2261-AR	200/289/302, rear, right hand, 7/8"	\$24. ⁹⁵ EA
67-73	C60Z-2262-AR	200/289/302, rear, left hand, 7/8"	\$24. ⁹⁵ EA
67-69	C7ZZ-2261-AR	351-428, rear, right hand, 13/16"	\$28. ⁹⁵ EA
67-69	C7ZZ-2262-AR	351-428, rear, left hand, 13/16"	\$28. ⁹⁵ EA
67-69	C9TZ-2061-BR	V8, front, right hand, 1 3/32"	\$28. ⁹⁵ EA
67-69	C9TZ-2062-BR	V8, front, left hand, 1 3/32"	\$28. ⁹⁵ EA

AXLE VENT, REAR



This concurs rear axle vent also serves double duty by securing rear brake hose to axle housing.

Year	Part No.	Description	List
64-66	C4ZW-4338-A	For use w/ non-GT Brake hose C5ZZ-2282-AR	\$8. ⁹⁵ EA
65-73	C8ZW-4338-A	For use w/ 65-66 GT Brake hose C5ZZ-2282-DR, and all 67-73	\$8. ⁹⁵ EA

WE PROUDLY FEATURE AUTHENTIC MUSTANG REPRODUCTIONS FROM SCOTT DRAKE!



ELECTRIC BRAKE PARTS

BRAKE EXTENSION LEAD



Connects brake master cylinder brake switch to engine

gauge harness.

Year	Part No.	List
64	C4ZZ-2140-EXT	\$14. ⁹⁵ EA

BRAKE LIGHT SWITCH ADAPTER



This is a high quality precision machined brass adapter.

Year	Part No.	List
64	DBC-A0813	\$34. ⁹⁵ EA

STOP LIGHT SWITCH



High quality replacement part. Non-original appearance

Year	Part No.	Description	List
64	C4DZ-13480-A	Early, 2 prong, screw in	\$15. ⁹⁵ EA
67-68	C9VY-13480-A	Power disc	\$9. ⁹⁵ EA
65-70	C9ZZ-13480-A	Manual	\$8. ⁹⁵ EA
67-70	C9ZZ-13480-B	Power drum	\$8. ⁹⁵ EA
71-73	D1ZZ-13480-A	Manual	\$8. ⁹⁵ EA
71-73	D1ZZ-13480-B	Power	\$8. ⁹⁵ EA

FRONT/REAR BRAKE LINES

BRAKE HOSE CLIP KIT



These clips attach rubber brake hose to mounting bracket.

Year	Part No.	List
64-73	78-2814	\$7. ⁵⁰ KI

BRAKE LINE AND FUEL LINE CLIP



Exact copy of the hard to find original. This two piece clip is used to mount gas and/or brake line to floor.

Year	Part No.	List
64-73	380374-S	\$3. ⁹⁵ EA

FRONT BRAKE LINE CLIP AND GROMMET KIT



These original style clips are the ones that hold your metal brake lines to the firewall. Also includes rubber brake line grom-

mets which fit in shock tower for brake line protection.

Year	Part No.	List
64-67	379604-AK	\$7. ⁹⁵ KI
67-69	379604-BK	\$11. ⁹⁵ KI

FRONT BRAKE LINE KIT



Exact copies of the originals. Steel tubing features tin/lead coating and plated zinc chromate fitting. Color coded

fittings like originals. **Don't forget our clip and grommet kit on the previous page!**

Year	Description	Part No.	List
64-65	Standard brakes (3 pc)	MFB001	\$47. ⁹⁵ SE
64-65	Standard brakes (3 pc), stainless	MFB001S	\$60. ⁹⁵ SE
66	Standard brakes (3 pc)	MFB002	\$47. ⁹⁵ SE
66	Standard brakes (3 pc), stainless	MFB002S	\$60. ⁹⁵ SE
65-66	GT disc brakes (6 pc)	MFB003	\$61. ⁶⁰ SE
65-66	GT disc brakes (6 pc), stainless	MFB003S	\$86. ⁹⁰ SE
68-69	Drum brakes only (5 pc)	MFB004	\$61. ⁶⁰ SE
68-69	Drum brakes only (5 pc), stainless	MFB004S	\$82. ⁵⁰ SE
68-69	Power disc brakes only (6 pc)	MFB005	\$65. ⁹⁵ SE
68-69	Power disc brakes only (6 pc), stainless	MFB005S	\$87. ⁹⁵ SE
67	Power disc brakes only (4 pc, before 2/1/67) w/ proportioning valve at rear of car	MFB006	\$60. ⁹⁵ SE
67	Power disc brakes only (4 pc, before 2/1/67) w/ proportioning valve at rear of car, stainless	MFB006S	\$82. ⁵⁰ SE
67	Drum brakes only (5 pc, before 2/1/67)	MFB007	\$61. ⁶⁰ SE
67	Drum brakes only (5 pc, after 2/1/67), stainless	MFB007S	\$90. ⁹⁵ SE
71-73	Standard drum brakes only (5 pc)	MFB008	\$62. ⁹⁵ SE
71-75	Power disk brakes only (5 pc)	MFB009	\$62. ⁹⁵ SE

Year	Description	Part No.	List
71-75	Power disc brakes only (5 pc), stainless	MFB009S	\$87. ⁹⁵ SE
69-70	Boss 429, power disk brakes only (4 pc)	MFB010	\$61. ⁶⁰ SE
70	Power disc brakes only (4 pc)	MFB011	\$62. ⁹⁵ SE
70	Power disc brakes only (4 pc), stainless	MFB011S	\$87. ⁹⁵ SE
67	Disc brakes (4 pc, after 2/1/67)	MFB012	\$61. ⁶⁰ SE
67	Disc brakes only (5 pc, after 2/1/67), stainless	MFB012S	\$82. ⁵⁰ SE
67	Drum brakes only (5 pc, after 2/1/67)	MFB013	\$61. ⁶³ SE
67	Drum brakes only (5 pc, before 2/1/67), stainless	MFB013S	\$82. ⁵⁰ SE
70	Drum brakes, stainless steel	MFB014S	\$74. ⁹⁵ ST
64-65	Power brakes	MFB015	\$47. ⁹⁵ SE
64-65	Power brakes, stainless	MFB015S	\$60. ⁹⁵ SE
66	Power brakes	MFB016	\$47. ⁹⁵ SE
66	Power brakes, stainless	MFB016S	\$60. ⁹⁵ SE
67	Power drum brakes (5 pc)	MFB017	\$60. ⁰⁰ EA
67	Power drum brakes (5 pc), stainless steel	MFB017S	\$85. ⁰⁰ EA
68-69	Power drum brakes	MFB018	\$59. ⁹⁵ SE

FRONT PARKING BRAKE CABLE



Fits from handle to equalizer. One required per car. All fit 6 or 8 cylinder. Cable only economy.

Year	Part No.	List
64-66	C5ZZ-2853-BR	\$21. ⁹⁵ EA
69-70	C9ZZ-2853-AR	\$21. ⁹⁵ EA
71-73	D1ZZ-2853-AR	\$29. ⁹⁵ EA

CONCOURS FRONT PARKING BRAKE CABLE

New by Scott Drake, these are made just like the originals with correct outer casing. Includes firewall seal, firewall bracket and retaining clip.

64-66	C5ZZ-2853-B	List
		\$26. ⁹⁵ EA
67-68	C7ZZ-2853-A	List
		\$26. ⁹⁵ EA



69-70
C9ZZ-2853-A

List
\$25.⁹⁵ EA

FRONT TO REAR BRAKE LINE KIT



Quality lines with correct fittings. These extra long lines have been gently bent in half so they are FedEx shippable.

Year	Description	Part No.	List
64-66	Front drum brakes w/ single exhaust	MLB001	\$37. ⁹⁵ EA
64-66	Front drum brakes w/ single exhaust, stainless	MLB001S	\$59. ⁹⁵ EA
68-69	All	MLB002	\$44. ⁹⁵ EA
68-69	All, stainless	MLB002S	\$64. ⁹⁵ EA
64-66	Front disc brakes w/ dual exhaust	MLB003	\$37. ⁹⁵ EA
64-66	Front disc brakes w/ dual exhaust, stainless	MLB003S	\$59. ⁹⁵ EA
67	Front disc brakes only, (2 pc, before 2/1/67) w/ proportioning valve at rear of car	MLB004	\$37. ⁹⁵ EA
67	Front disc brakes only (4 pc, before 2/1/67) w/ proportioning valve at rear of car, stainless	MLB004S	\$59. ⁹⁵ EA
67	Front drum brakes (before 2/1/67)	MLB005	\$37. ⁹⁵ EA
67	Front drum brakes (before 2/1/67), stainless	MLB005S	\$59. ⁹⁵ EA
72-73	Front disc brakes	MLB006	\$44. ⁹⁵ EA
70	Front disc brakes	MLB007	\$44. ⁹⁵ EA
70	Front disc brakes, stainless	MLB007S	\$64. ⁹⁵ EA
67	Front disc brakes (2 pc, after 2/1/67)	MLB008	\$37. ⁹⁵ EA
67	Front disc brakes (2 pc, after 2/1/67), stainless	MLB008S	\$59. ⁹⁵ EA
64-66	Front disc brakes w/ single exhaust	MLB009	\$37. ⁹⁵ EA
70	Front drum brakes	MLB010	\$44. ⁹⁵ EA
70	Front drum brakes, stainless	MLB010S	\$64. ⁹⁵ EA
72-73	Front drum brakes	MLB011	\$44. ⁹⁵ EA
72-73	Front drum brakes, stainless	MLB011S	\$66. ⁰⁰ EA
67	Front drum brakes (after 2/1/67)	MLB012	\$37. ⁹⁵ EA

67	Front drum brakes (after 2/1/67), stainless	MLB012S	\$59. ⁹⁵ EA
64-66	Front drum brakes w/ dual exhaust	MLB013	\$37. ⁹⁵ EA
64-66	Front drum brakes w/ dual exhaust, stainless	MLB013S	\$59. ⁹⁵ EA
71	Front power or standard drum brakes, stainless	MLB014S	\$64. ⁹⁵ EA
71	Front disc brakes	MLB015	\$44. ⁹⁵ EA
71	Front disc brakes, stainless	MLB015S	\$64. ⁹⁵ EA

REAR END HOUSING BRAKE LINE KIT



These lines run from rear end junction box to each rear wheel cylinder. Precisely bent, exact copy.

Year	Description	Part No.	List
64-66	8 cylinder, except GT	MHB001	\$24. ⁹⁵ SE
64-66	8 cylinder, except GT, stainless	MHB001S	\$35. ⁹⁵ SE
64-66	6 cylinder	MHB002	\$24. ⁵⁰ SE
64-66	6 cylinder, stainless	MHB002S	\$35. ⁹⁵ SE
67-69	8 cylinder, 8"	MHB003	\$37. ⁹⁵ SE
67-69	8 cylinder, 8", stainless	MHB003S	\$43. ⁹⁵ SE
64-66	8 cylinder, dual exhaust	MHB004	\$23. ⁰⁰ SE
64-66	8 cylinder, dual exhaust, stainless	MHB004S	\$35. ⁹⁵ SE
71-73	All	MHB005	\$36. ⁹⁵ SE
71-73	Stainless-All	MHB005S	\$43. ⁹⁵ SE
68-69	8 cylinder, 9", 31 spline	MHB006	\$35. ⁹⁵ SE
68-69	8 cylinder, 9", 31 spline, stainless	MHB006S	\$43. ⁹⁵ SE
65-66	8 cylinder, 9"	MHB007	\$23. ⁰⁰ SE
65-66	8 cylinder, 9", stainless	MHB007S	\$35. ⁹⁵ SE
70	8 cylinder, 9"	MHB008	\$36. ⁹⁵ SE
70	8 cylinder, 9", stainless	MHB008S	\$43. ⁹⁵ SE
70	8"	MHB009	\$36. ⁹⁵ SE
70	8", stainless	MHB009S	\$43. ⁹⁵ SE
68	8 cylinder, 9", 28 spline	MHB011	\$36. ⁹⁵ SE
68	8 cylinder, 9", 28 spline, stainless	MHB011S	\$43. ⁹⁵ SE
67	8 cylinder, 9"	MHB012	\$36. ⁹⁵ SE
67	8 cylinder, 9", stainless	MHB012S	\$43. ⁹⁵ SE
69	8 cylinder, 9", 28 spline	MHB013	\$36. ⁹⁵ SE
69	8 cylinder, 9", 28 spline, stainless	MHB013S	\$43. ⁹⁵ SE

PARKING BRAKE ASSEMBLY



Complete assemblies as sold from Ford. Good reproductions includes either plastic pull handle or rubber pad pedal.

Year	Part No.	List
64-66	C5ZZ-2780-A	\$79. ⁹⁵ EA
67-68	C7ZZ-2780-A	\$79. ⁹⁵ EA
69	C9ZZ-2780-A	\$79. ⁹⁵ EA
70	D0ZZ-2780-A	\$79. ⁹⁵ EA

PARKING BRAKE HANDLE

High quality injection molded parts, mounting lock pin and allen set screw included. Excellent detail in a reproduction part. Black with white "Brake" lettering (1964 - 1966) on ribbed face of handle. Later handles (1967 - 1968) are all black. New improved metal insert. Thicker than original. Includes original drive pin as well as an allen head socket set screw to allow easy removal and installation in the future.



64-66
CODZ-2760-B

List
\$7.⁹⁵ EA



67-68
C7ZZ-2760-B

List
\$7.⁹⁵ EA

BILLET PARKING BRAKE HANDLE



Machined from solid billet aluminum. This handle is highly durable while adding a touch of class to your interior. *A perfect compliment to our new Billet Pedals (See Interior Section).*

Year	Description	Part No.	List
64-68	Billet	B-2760-BL	\$39. ⁹⁵ EA

PARKING BRAKE PEDAL PAD



Made by Scott Drake, this Parking Brake Pad is an exact copy of the original. Molded from wear resistant rubber for years of use.

Year	Description	Part No.	List
69-73	Note: will NOT fit 1970 Mustang or Cougar	C9ZZ-2454-A	\$5. ⁹⁵ EA

WE PROUDLY FEATURE AUTHENTIC MUSTANG REPRODUCTIONS FROM SCOTT DRAKE!



PARKING BRAKE PEDAL PAD TRIM



Made from stainless steel, just like the originals.

Year	Description	Part No.	List
69-73	Note: will NOT fit 1970 Mustang or Cougar	C9ZZ-2A487-C	\$9.95 ^{EA}

PARKING BRAKE PULLEY



The pulley that the emergency brake cable rides on.

Year	Description	Part No.	List
65-68	Gold anodized	OM-2804	\$22.95 ^{EA}

PARKING BRAKE ASSEMBLY BOLTS



Year	Part No.	List
64-68	379949-S	\$3.25 ^{PR}

PARKING BRAKE LEVER SPRING



Exact O.E.M. replacement, not an over the counter universal spring. Painted black.

Year	Part No.	List
64-66	CSZZ-2A651-A	\$6.95 ^{EA}



Made by Drake, our 1969-70 Mustang Front Brake Cable Spring and Cap are a perfect match

for our 1969-70 Mustang Concoors Front Park Brake Cable. Scott Drake made these using the original Ford Prints and finishing them with a rust resistant black powder coat.

Year	Part No.	List
69-70	C9ZZ-2A651-K	\$8.95 ^{EA}

CONCOURS REAR PARKING BRAKE CABLE



New by Drake! These are exact copies of the originals.

Year	Desc	Part No.	List
64-65	LH or RH	CSZZ-2A635-E	\$29.95 ^{EA}
66	1 piece	C6ZZ-2A635-C	\$62.50 ^{EA}

REAR PARKING BRAKE CABLE



Year from equalizer to rear brakes. 2 Req, 6 or 8 cyl, L.H. or R.H.

Year	Description	Part No.	List
65-66	1 piece, for rear disc not SSBC, can also fit 1965 but requires additional parts	C6ZZ-2A635-RDB	\$114.95 ^{EA}
67	6 or 8 cyl., left or right hand (2 req.)	C7ZZ-2A635-AR	\$42.50 ^{EA}
67-70	For rear disc brakes not SSBC	C7ZZ-2A635-RDB	\$54.95 ^{PR}
68-69	8 cylinder, left hand (1 req.)	C8ZZ-2A635-AR	\$41.95 ^{EA}
68	6 cylinder, right hand (1 req.)	C8ZZ-2A635-BR	\$44.95 ^{EA}
68-70	6 cylinder, left hand (1 req.)	C8ZZ-2A635-CR	\$31.95 ^{EA}
68	8 cylinder, right hand (1 req.)	C8ZZ-2A635-DR	\$64.95 ^{EA}
69	6 cylinder, right hand (1 req.) for early style cars built before 2-17-69	C9ZZ-2A635-AR	\$47.95 ^{EA}
69	8 cylinder, right hand (1 req.)	C9ZZ-2A635-CR	\$64.95 ^{EA}
70-73	8 cylinder, right hand (1 req.)	D0ZZ-2A635-AR	\$40.95 ^{EA}
70-73	8 cylinder, left hand (1 req.)	D0ZZ-2A635-BR	\$40.95 ^{EA}

PARKING BRAKE CABLE CONNECTOR



This is the saddle shaped piece that connects the two rear parking brake cables together.

Year	Part No.	List
67-73	C60Z-2A790-A	\$6.95 ^{EA}

PARKING BRAKE CABLE IDLER



Keeps proper tension on emergency brake cable by taking up the slack

when the brake is off. Painted natural steel gray.

Year	Part No.	List
67-73	C7ZZ-2A808-A	\$11.95 ^{EA}

REAR PARKING BRAKE BRACKETS

Required to correctly hold the parking brake cable in place.



64-65
CSZZ-2649-C/D

List
\$13.95 ^{EA}



66
C6ZZ-2649-C/D

List
\$15.95 ^{EA}

PARKING BRAKE CABLE IDLER BRACKET



This bracket mounts to the floor pan and acts as an anchor for the idler. Welding required.

Year	Part No.	List
67-73	C7ZZ-2A816-A	\$18.95 ^{EA}

PARKING BRAKE EQUALIZER

Parking Brake Equalizer. Zinc plated for years of service. Made by Scott Drake



64-65
CSZZ-2A602-A

List
\$14.95 ^{EA}



66
C0DD-2A602-A

List
\$15.95 ^{EA}



67-73
C60Z-2A602-A

List
\$15.95 ^{EA}

PARKING BRAKE EQUALIZER LEVER



Made from heavy gauge stamped steel, a quality reproduction.

Year	Part No.	List
65-66	CSZZ-2A605-A	\$21 ⁹⁵ EA
67-68	C7ZZ-2A605-A	\$9 ⁹⁵ EA

PARKING BRAKE EQUALIZER ROD



A concours reproduction. Zinc plated like the originals.

Year	Part No.	List
64-66	B7A-2628-B	\$11 ⁹⁵ EA
67-68	C7ZZ-2628-B	\$13 ⁹⁵ EA

BRAKE PEDALS

BRAKE PEDAL PAD



Made by Scott Drake with exact detail of the original. Compression molded rubber. Disc brake versions include stainless steel center trim.

Year	Description	Part No.	List
64-67	W/power drum brakes	CSZZ-2457-E	\$11 ⁹⁵ EA
64-67	Drum brakes. automatic trans	CSZZ-2457-F	\$11 ⁹⁵ EA
65-73	Drum brakes. manual trans	CSZZ-2457-G	\$11 ⁹⁵ EA
68-73	Drum brakes. automatic trans	C60Z-2457-A	\$11 ⁹⁵ EA

BRAKE PEDAL PAD



Made by Scott Drake with exact detail of the original. Compression molded rubber. Disc brake versions include stainless steel center trim.

Year	Description	Part No.	List
65-67	Disc brakes. automatic trans	CSZZ-2454-C	\$11 ⁹⁵ EA
64-67	Disc brakes. manual trans	CSZZ-2454-D	\$11 ⁹⁵ EA
68-73	Disc brakes. automatic trans	D3ZZ-2454-G	\$11 ⁹⁵ EA

BRAKE PEDAL PAD TRIM



Replacement brake pedal pad trim.

Year	Description	Part No.	List
65-67	Auto trans	CSZZ-2A487-B	\$8 ⁵⁰ EA
68-73	Auto trans	C60Z-2A487-A	\$10 ⁹⁵ EA
65-73	Man trans	D1ZZ-2A487-B	\$11 ⁹⁵ EA

BRAKE AND CLUTCH PEDAL BUSHING



Made from high strength, wear resistant plastic. Four required for automatic cars, six for manual transmission cars.

Year	Part No.	List
64-73	B7AZ-2471-A	\$1 ⁰⁰ EA

BRAKE AND CLUTCH PEDAL SUPPORT



Complete assembly stamped construction includes pressed in bushings.

Year	Part No.	List
64-66	CSZZ-6501508-A	\$64 ⁹⁵ EA
67-68	C7ZZ-6501508-A	\$74 ⁹⁵ EA
70	DOZZ-6501508-A	\$74 ⁹⁵ EA

POWER BRAKE PEDAL



This pedal required when switching over to factory power brakes. This pedal is not required when using our power brake conversions. *Note: will*

fit 1967 but must use 1968 Brake Pad. Will fit 1970 but must use 67-69 Factory Brake Booster.

Year	Description	Part No.	List
68-69	Automatic trans	DBC-A21184	\$94 ⁹⁵ EA
68-69	Manual trans	DBC-A21185	\$134 ⁹⁵ EA

BRAKE & CLUTCH PEDAL / PEDAL SUPPORT REBUILD KIT



This kit has everything you need to repair your clutch and brake pedal and pedal support in one easy kit. Includes 378200-K, CSZZ-2478-AK and 2

additional B7AZ-2471-A. See Transmission section for Roller bearing upgrade kit.

Year	Part No.	List
64-70	CSZZ-2478-MK	\$34 ⁹⁵ KI

WE PROUDLY FEATURE AUTHENTIC MUSTANG REPRODUCTIONS FROM SCOTT DRAKE!



BUMPERS

FRONT BUMPERS

CHROME FRONT BUMPERS



Chrome finish gives the car a nice look. An affordable alternative

to expensive re-chroming. Bumper bolts not included.

Year	Part No.	List
64-66	CSZZ-17757-AR	\$119. ⁹⁵ EA
67-68	C7ZZ-17757-AR	\$119. ⁹⁵ EA
69-70	C9ZZ-17757-AR	\$119. ⁹⁵ EA
71-72	D1ZZ-17757	\$139. ⁹⁵ EA

INNER FRONT BUMPER BRACE



Stamped from a heavy gauge metal. Painted black.

Year	Description	Part No.	List
64-66	Right hand	CSZZ-17766-AR	\$14. ⁹⁵ EA
64-66	Left hand	CSZZ-17767-AR	\$14. ⁹⁵ EA
67-68	Right hand	C7ZZ-17766-AR	\$14. ⁹⁵ EA
67-68	Left hand	C7ZZ-17767-AR	\$14. ⁹⁵ EA
69-70	Right hand	C9ZZ-17766-AR	\$19. ⁹⁵ EA
69-70	Left hand	C9ZZ-17767-AR	\$19. ⁹⁵ EA
71-73	Right hand	D1ZZ-17766-AR	\$19. ⁹⁵ EA
71-73	Left hand	D1ZZ-17767-AR	\$19. ⁹⁵ EA

CONCOURS OUTER FRONT BUMPER BRACE



Tired of Bumper Braces that do not fit without bending, grinding and drilling. Our Brackets were copied off of original Ford Blue Prints and our Welding Jigs were created using NOS Ford Original samples. Top Plates feature correct curvature and a slightly oversized hole to allow for both Original and Reproduction Bumper installations. We use thicker walled tubing than Economy Version and our 67-70 Braces feature a correct welded Tabs to hold the rubber Anti-rattle Pads in place for a truly concours reproduction.

Year	Part No.	List
64-66	CSZZ-17754/5-A	\$34. ⁹⁵ PR
67-68	C7ZZ-17754/5-A	\$39. ⁹⁵ PR
69-70	C9ZZ-17754/5-A	\$39. ⁹⁵ PR

ECONOMY OUTER FRONT BUMPER BRACE



Tubular construction, painted black.

Year	Description	Part No.	List
64-66	Right hand	CSZZ-17754-AR	\$10. ⁹⁵ EA
64-66	Left hand	CSZZ-17755-AR	\$10. ⁹⁵ EA
67-68	Right hand	C7ZZ-17754	\$10. ⁹⁵ EA
67-68	Left hand	C7ZZ-17755	\$10. ⁹⁵ EA
69-70	Right hand	C9ZZ-17754-AR	\$16. ⁹⁵ EA
69-70	Left hand	C9ZZ-17755-AR	\$16. ⁹⁵ EA

FRONT BUMPER BRACE MOUNTING HARDWARE



Concours correct for 1964-66 Mustangs, but will also fit 67-73 Mustangs. Mounts bumper braces to frame rail

Year	Part No.	List
64-66	372434-FBK	\$9. ⁹⁵ KT

FRONT BUMPER BRACKET



Steel stamping. Secures bumper to front fender side.

Year	Description	Part No.	List
64-66	RH	CSZZ-17A869-A	\$3. ⁵⁰ EA
64-66	LH	CSZZ-17A870-A	\$3. ⁵⁰ EA
67-68	RH	C7ZZ-17A869-A	\$2. ⁹⁵ EA
67-68	LH	C7ZZ-17A870-A	\$3. ⁹⁵ EA
69-70	RH or LH	C9ZZ-17B762-A	\$3. ⁹⁵ EA

FRONT BUMPER GUARD



Features a heavy gage steel stamping. Our 1964-66 version is Made by Drake and is the best on the market with flawless chrome. Sold in pairs.

Year	Description	Part No.	List
64-66	Concours	CSZZ-17996/7-CB	\$39. ⁹⁵ PR
67-68	W/ trim holes	C7ZZ-17996/7-A	\$39. ⁹⁵ PR
67-68	W/out trim holes	C7ZZ-17996/7-B	\$45. ⁹⁵ PR

FRONT BUMPER GUARD BRACKET



Die stamped from heavy gauge steel and painted black. Perfect copy. Mounts on inner bumper brace.

Year	Part No.	List
64-66	CSZZ-17B794-A	\$4. ⁵⁰ EA

FRONT BUMPER GUARD HARDWARE KIT

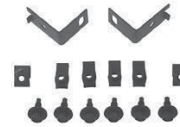

These kits make mounting bumper guards a breeze.

Year	Description	Part No.	List
64-66	Bolt kit	359530-K	\$3. ⁵⁰ KI
64-66	Clip kit	370328-K	\$4. ⁹⁵ KI
64-66	Bolt, bracket and clip kit	CSZZ-17794-KIT	\$14. ⁹⁵ KI

FRONT BUMPER GUARD TRIM



E.P.D.M. rubber featuring steel insert and mounting studs. Steel insert is cadmium plated to prevent rust. An excellent reproduction.

Year	Part No.	List
67	C7ZZ-17A812-A	\$5. ²⁵ EA

FENDER/BUMPER FILLERS



For 71-72 Mustangs with chrome front bumper. This is molded soft plastic that fills the gap between the bumper and fender. Exact reproduction and exact colors as the originals. Includes attaching screws.

Year	Part No.	List
71-72	D1ZZ-16554	\$54. ⁹⁵ PR

SHOP WITH CONFIDENCE! WE OFFER SUPERIOR-QUALITY PARTS FOR ALL YOUR MUSTANG RESTORATION NEEDS.

REAR BUMPER

CHROME REAR BUMPERS



Chrome finish gives the car a nice look. An affordable alternative to expensive re-chroming. Bumper bolts not included.

Year	Part No.	List
64-66	C5ZZ-17906-AR	\$119.95 ^{EA}
67-68	C7ZZ-17906-AR	\$119.95 ^{EA}
69-70	C9ZZ-17906-AR	\$119.95 ^{EA}
71-73	D1ZZ-17906-A	\$139.95 ^{EA}

REAR BUMPER BODY PAD



Our die cut foam rubber donuts help cushion the brace from the tail panel.

Year	Part No.	List
65-73	C5ZZ-6540996	\$1.95 ^{SE}

REAR BUMPER BRACE



Stamped steel. Painted black. A nice reproduction. New tooling! Now features the same thickness as the originals.

Year	Description	Part No.	List
64-66	Best quality	C5ZZ-17A750-A	\$15.95 ^{EA}
64-66	Economy	C5ZZ-17A750-AR	\$13.95 ^{EA}
67-68	All	C7ZZ-17A750-AR	\$13.95 ^{EA}
69-70	All	C9ZZ-17A750-AR	\$14.95 ^{EA}
71-72	Right hand	D1ZZ-17A750-AR	\$14.95 ^{EA}
71-72	Left hand	D1ZZ-17A751-AR	\$14.95 ^{EA}

REAR BUMPER BRACE MOUNTING HARDWARE



Concours correct for 1964-66 Mustangs, but will also fit 67-73 Mustangs.

Year	Part No.	List
64-66	372434-RBK	\$10.95 ^{KT}

REAR BUMPER GUARD



Precision steel stamping from heavy gage steel. Trim not included.

Year	Description	Part No.	List
64-66	Chrome	C5ZZ-17984-C	\$40.00 ^{PR}
67-68	Black w/ trim	C7ZZ-17984-AR	\$34.95 ^{PR}
67-68	Chrome w/ trim	C7ZZ-17984-CR	\$40.95 ^{PR}

REAR BUMPER GUARD BRACKET



Steel stamping and painted black. Just like originals.

Year	Part No.	List
64-66	C5ZZ-17B876/7-A	\$21.95 ^{PR}
67-68	C7ZZ-17B876/7-A	\$26.95 ^{PR}

REAR BUMPER GUARD TRIM

Trim that attaches to the rear bumper guards, protecting the chrome.



67-68
C7ZZ-17A807-A

List
\$5.25^{EA}



73
D1ZZ-17A812

List
\$18.95^{PR}

REAR BUMPER LICENSE LAMP



Mounts on rear bumper. Good copy of original, includes lens, bulb and correct wiring pigtail.

Year	Part No.	List
64-70	C5ZZ-13550-A	\$29.95 ^{EA}
71-73	D1ZZ-13550-A	\$24.95 ^{EA}

BUMPER WAVE WASHER



Stamped of spring steel and zinc plated to stop rust.

Year	Part No.	List
64-70	C5ZZ-17A924	\$0.75 ^{EA}

BUMPER BOLT KIT



These time saving kits contain everything you need to install the front and rear bumpers. Deluxe kits include wave washers.

Year	Description	Part No.	List
64-68	Concours, deluxe 28 pc	C4ZB-17758-DLXK	\$20.95 ^{KT}
64-70	Deluxe 28 piece kit	C5ZZ-17758-DLXK	\$16.95 ^{KI}
64-70	Standard 20 piece kit	C5ZZ-17758-K	\$12.95 ^{KI}
69-70	Concours 20 piece kit	C9ZZ-17758-K	\$12.95 ^{KI}
69-73	Concours 28 piece kit, Deluxe	C9ZZ-17758-DLXK	\$16.95 ^{KI}

BUMPER BOLT



A variety of bumper bolts are offered to fit your application.

Year	Desc	Part No.	Year	List
64-70	Small	376337-S	64-70	\$0.95 ^{EA}
64-68	Concours	C4ZB-17758-A	64-68	\$1.95 ^{EA}
64-68	Standard	C5ZZ-17758-A	64-68	\$1.00 ^{EA}

BUMPER NUT



Special serrated flange nut. Attaches to bumper bolts.

Year	Description	Part No.	List
64-73	7/16x14 inch threads	375918-S	\$0.75 ^{EA}

BUMPER GUARD CUSHION



Used to deaden the noise between the bumper and bumper guards. Quality molded rubber.

Year	Description	Part No.	List
64-66	Set of 4	379944-S	\$4.00 ^{SE}

WE PROUDLY FEATURE AUTHENTIC MUSTANG REPRODUCTIONS FROM SCOTT DRAKE!



CONVERTIBLE

BOOTS

CONVERTIBLE TOP BOOT



Made from original patterns for a wrinkle free look.

Features perfect fit and long lasting vinyl. Includes foam pads. Will not fit Shelby.

Year	Description	Part No.	List
64-66	Black	C5ZZ-7654400-BK	\$92. ⁵⁰ EA
64-65	Medium Blue	C5ZZ-7654400-BL	\$92. ⁵⁰ EA
66	Dark red	C5ZZ-7654400-DR	\$92. ⁵⁰ EA
66	Emberglow	C5ZZ-7654400-EM	\$92. ⁵⁰ EA
64-66	Ivy gold	C5ZZ-7654400-IG	\$92. ⁵⁰ EA
65-66	Light blue	C5ZZ-7654400-LB	\$92. ⁵⁰ EA
64-65	Palomino	C5ZZ-7654400-PA	\$92. ⁵⁰ EA
66	Parchment	C5ZZ-7654400-PR	\$92. ⁵⁰ EA
64-65	Bright Red	C5ZZ-7654400-RD	\$92. ⁵⁰ EA
66	Turquoise	C5ZZ-7654400-TQ	\$92. ⁵⁰ EA
64-66	White	C5ZZ-7654400-WT	\$92. ⁵⁰ EA
67	Black	C7ZZ-7654400-BK	\$92. ⁵⁰ EA
67	Dark red	C7ZZ-7654400-DR	\$92. ⁵⁰ EA
67	Ivy gold	C7ZZ-7654400-IG	\$92. ⁵⁰ EA
67	Light blue	C7ZZ-7654400-LB	\$92. ⁵⁰ EA
67	Palomino	C7ZZ-7654400-PA	\$92. ⁵⁰ EA
67	Parchment	C7ZZ-7654400-PR	\$92. ⁵⁰ EA
67	Saddle	C7ZZ-7654400-SA	\$92. ⁵⁰ EA
67	Turquoise	C7ZZ-7654400-TQ	\$92. ⁵⁰ EA
67	White	C7ZZ-7654400-WT	\$92. ⁵⁰ EA
68	Black	C8ZZ-7654400-BK	\$92. ⁵⁰ EA
68	Dark red	C8ZZ-7654400-DR	\$92. ⁵⁰ EA
68	Ivy gold	C8ZZ-7654400-IG	\$92. ⁵⁰ EA
68	Light blue	C8ZZ-7654400-LB	\$92. ⁵⁰ EA
68	Maroon	C8ZZ-7654400-MR	\$92. ⁵⁰ EA
68	Palomino	C8ZZ-7654400-PA	\$92. ⁵⁰ EA
68	Parchment	C8ZZ-7654400-PR	\$92. ⁵⁰ EA
68	Saddle	C8ZZ-7654400-SA	\$92. ⁵⁰ EA
68	Turquoise	C8ZZ-7654400-TQ	\$92. ⁵⁰ EA
68	White	C8ZZ-7654400-WT	\$92. ⁵⁰ EA
69-70	Black	C9ZZ-7654400-BK	\$92. ⁵⁰ EA
70	Blue	C9ZZ-7654400-BL	\$92. ⁵⁰ EA
69	Dark red	C9ZZ-7654400-DR	\$92. ⁵⁰ EA
70	Ginger	C9ZZ-7654400-GI	\$92. ⁵⁰ EA
69	Ivy gold	C9ZZ-7654400-IG	\$92. ⁵⁰ EA
70	Ivy	C9ZZ-7654400-IV	\$92. ⁵⁰ EA
69	Light blue	C9ZZ-7654400-LB	\$92. ⁵⁰ EA
69	Nugget gold	C9ZZ-7654400-NG	\$92. ⁵⁰ EA
70	Vermillion	C9ZZ-7654400-VE	\$92. ⁵⁰ EA
69-70	White	C9ZZ-7654400-WT	\$92. ⁵⁰ EA
71-73	Black	D1ZZ-7654400-BK	\$92. ⁵⁰ EA
71-73	Blue	D1ZZ-7654400-BL	\$92. ⁵⁰ EA
71-73	Ginger	D1ZZ-7654400-GI	\$92. ⁵⁰ EA

Year	Description	Part No.	List
71-73	Green	D1ZZ-7654400-GR	\$92. ⁵⁰ EA
71-73	Vermillion	D1ZZ-7654400-VE	\$92. ⁵⁰ EA
71-73	White	D1ZZ-7654400-WT	\$92. ⁵⁰ EA
68	Black Shelby	S8MS-7654400-BK	\$99. ⁹⁵ EA

CONVERTIBLE TOP BOOT BAG

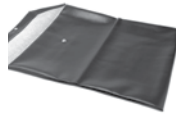

Heavy vinyl, felt-backed construction. Protects top boot from dirt and grime.

Year	Description	Part No.	List
64-73	Black	BB-FM-BK	\$14. ⁹⁵ EA
64-73	Plaid	BB-FM-PLD	\$14. ⁹⁵ EA
64-73	Speckled	BB-FM-SPK	\$11. ⁹⁵ EA
64-73	White	BB-FM-WT	\$11. ⁹⁵ EA

CONVERTIBLE TOP BOOT SNAP KIT



Great quality kit. This one features 17 snaps, with correct length and 17 retainers. Snaps are made from stainless steel so they will not rust! 64-66 pictured.

Year	Part No.	List
64-66	359274-SK	\$24. ⁹⁵ KI
67	359274-S67	\$25. ⁹⁵ KI

ELECTRICAL

BEZEL INSTALLATION TOOL



This dedicated tool is perfect for installing or removing the chrome bezel on

our 1967 Mustang Convertible Top Switch, or the bezel on our 2010 Mustang Billet Antenna.

Year	Description	Part No.	List
67	1967 CV Top Switch Bezel & 2010 Antenna Bezel	T-67-BK	\$18. ⁹⁵ EA

CONVERTIBLE TOP HARNESS



This is the main harness for the power convertible top. Made in the USA. Correct color coded wires

and factory style loom cover includes circuit breaker. Note: 64-66 version will also work on 67-68

Year	Description	Part No.	List
64-68	Concours for 64-66	C5ZZ-7615A668	\$79. ⁹⁵ EA
67-68	Concours for 67-68	C7ZZ-7615A668	\$79. ⁹⁵ EA

UNDER HOOD CONVERTIBLE TOP HARNESS



This wiring harness links the convertible top switch to the circuit breaker under the hood on 1964 through 1966 Mustangs.

Part No.	Year	List
C4DZ-15668-B	64-66	\$15. ⁹⁵ EA

CONVERTIBLE TOP SWITCH



New and Improved by Scott Drake. This 1964-66 Mustang Convertible Top Switch is made from all new tooling, featuring correct length shaft, correct color coded

wires properly riveted to the switch. Perfect fit for Knob and Bezel part # C4DZ-10852-K (sold separately). Note: This is also correct for tailgate window on Falcons.

Year	Description	Part No.	List
64-66	Improved tooling	C4DZ-15668-A	\$44. ⁹⁵ EA



C7ZZ-15668-A Includes bezel and knob
C7ZZ-15668-A

List
\$54.⁹⁵ EA



69-70
C9ZZ-15668

List
\$55.⁹⁵ EA



D1ZZ-15668

List
\$55.⁹⁵ EA

CONVERTIBLE TOP SWITCH BEZEL & KNOB



Quality chrome plated with black painted "UP" and "DN" markings. Retaining nuts included.

Part No.	Year	List
C4DZ-10852-K	64-66	\$36. ⁹⁵ SE

CONVERTIBLE TOP TO SWITCH CIRCUIT BREAKER



This wiring harness links the convertible top switch to the circuit breaker under the hood on 1964 through 1966 Mustangs.

Year	Part No.	Description	List
65-70	CSZZ-14448-A	Does not fit 66	\$12. ⁹⁵ KI
66	C6ZZ-14448-A		\$24. ⁹⁵ KI

HYDRAULICS

CONVERTIBLE PUMP MOTOR AND RESERVOIR



All new, not rebuilt. Excellent U.S.A. quality

Year	Description	Part No.	List
64-73	U.S.A.	C4DZ-7653337-A	\$294. ⁹⁵ EA
64-73	Import	C4DZ-7653337-AR	\$249. ⁹⁵ EA

CONVERTIBLE TOP HYDRAULIC CYLINDER



These are all new, not rebuilt or off the shelf generic replacements.

Guaranteed for one year. Made in USA.

Year	Description	Part No.	List
64-70	USA	CSZZ-7650600-AR	\$178. ⁹⁵ EA
64-70	Imported	CSZZ-7650600-A	\$124. ⁹⁵ EA
71	USA	D1ZZ-7650600-A	\$178. ⁹⁵ EA
72-73	USA, Left hand	D2ZZ-7650600-A	\$178. ⁹⁵ EA
72-73	USA, Right hand	D2ZZ-7650601-A	\$178. ⁹⁵ EA

CONVERTIBLE TOP HYDRAULIC HOSE LINE



Clear hydraulic hoses that have the correct brass machined fittings.

Year	Part No.	List
64-70	CSZZ-7653456-A	\$84. ⁹⁵ KI

LATCHES & COMPONENTS

CV TOP CLAMP TRUSS HEAD REPAIR KIT



Designed for easy installation. Does not require top disassembly.

Year	Part No.	List
65-68	380348-S	\$9. ⁹⁵ KI

CV TOP CLAMP TRUSS HEAD SCREW



Concours correct. Requires top to be disassembled.

Year	Part No.	List
64-68	380348-SK	\$7. ⁵⁰ EA

CONVERTIBLE TOP CLEVIS PIN KIT



This complete 10 piece kit includes nylon bushings, chrome pivot rivets, locking wave washers, and locking clevis pins.

Year	Part No.	List
64-68	378887-SK	\$19. ⁹⁵ KI

CONVERTIBLE TOP DOWEL PINS



Helps top alignment as top goes down onto our visor brackets.

Year	Part No.	List
64-68	CSZZ-76514A38-B	\$19. ⁹⁵ PR

CONVERTIBLE TOP HOLD DOWN CLAMPS



Made by Scott Drake with exacting details. Year 1965-68 Convertibles with manual tops.

Year	Description	Part No.	List
64-68	RH and LH	CSZZ-7650500/1D	\$29. ⁹⁵ PR
64-68	RH	CSZZ-7650500-D	\$16. ⁹⁵ EA
64-68	LH	CSZZ-7650501-D	\$16. ⁹⁵ EA

CONVERTIBLE TOP HOOK



Beautifully chrome plated, features correct thread size. Forged like originals.

Year	Part No.	List
64-66	CSZZ-7650536-A	\$12. ⁹⁵ PR
67-73	C6AZ-76506A48-A	\$12. ⁹⁵ PR

CONVERTIBLE TOP LATCH ASSEMBLY



Finished assembly ready to install. Features hold down clamp handle, pivots, spring and top hook.

Year	Description	Part No.	List
64-68	Right hand	CSZZ-7650508-K	\$174. ⁹⁵ EA
64-68	Left hand	CSZZ-7650509-K	\$174. ⁹⁵ EA

CONVERTIBLE TOP LATCH HANDLE



Year	Description	Part No.	List
71-73	Right hand	D1ZZ-7650508-A	\$69. ⁹⁵ EA
71-73	Left hand	D1ZZ-7650509-A	\$69. ⁹⁵ EA

CONVERTIBLE TOP LATCH MOUNTING BASE



This is the base that the latch handle mounts to on the convertible top frame. Sold as a pair.

Year	Part No.	List
64-67	CSZB-7650500/1B	\$159. ⁹⁵ PR

WE PROUDLY FEATURE AUTHENTIC MUSTANG REPRODUCTIONS FROM SCOTT DRAKE!



CONVERTIBLE TOP LATCH SPRING



These are the 3 inch springs that keep tension on the convertible top latches, allowing them to lock in place. Sold as a pair.

Year	Part No.	List
64-73	CSZZ-7650572-A	\$7.95 ^{PR}

CONVERTIBLE BOOT QUARTER

New and improved design that is much easier to install and much more durable than original tubular Rivet that must be crimped over. Serrated Flanged Nut prevents Snaps from pulling out and nuts from backing off. A real time saver from original design.



Year	Part No.	List
64-68	CSZZ-7602628-A	\$10.95 ^{SE}

CONVERTIBLE TOP TENSION CABLE



A quality rust proof stainless steel cable which features all the correct hardware.

Year	Description	Part No.	List
64-65	Stud type	CSZZ-7652806-A	\$23.95 ^{PR}
65-68	Spring type	CSZZ-7652806-B	\$23.95 ^{PR}
69-70		C9ZZ-7652806-A	\$23.95 ^{PR}

CONVERTIBLE TOP REPAIR MANUAL



The convertible top is the most complicated part of any car. Manual features complete top replacement, adjustments, servicing,

electrical and trouble-shooting. 15 pages soft bound.

Year	Part No.	List
64-66	MP-14	\$8.50 ^{EA}

MOLDINGS

CONVERTIBLE HEADER MOLDING



Good fitting alternative to the original.

Year	Description	Part No.	List
64-67	Chrome	CSZZ-7603606-A	\$84.95 ^{EA}
68	Chrome	C8ZZ-7603606-A	\$89.95 ^{EA}
68	Argent	C8ZZ-7603606-AR	\$94.95 ^{EA}

CONVERTIBLE TOP BOOT REAR MOLDING



Features polished stainless steel finish and a great fit. Snaps not included.

Year	Part No.	List
64-66	CSZZ-76423A20-A	\$59.95 ^{EA}

CONVERTIBLE TOP BOOT SIDE MOLDING



Now made by Scott Drake. Features beautiful chrome finish and great fit. Snaps

not included. These are superior to the cheap imported versions available on the market.

Year	Part No.	List
64-66	CSZZ-76423A18/9	\$124.95 ^{PR}

CONVERTIBLE SUN VISOR BRACKETS



These are the best reproductions available! Show car quality with triple chrome

plating. Includes L.H. & R.H. brackets with attached visor pivot.

Year	Description	Part No.	List
64-66	Chrome	CSZZ-76423A18/9	\$124.95 ^{SE}



Year	Description	Part No.	List
67-68	Chrome	CSZZ-76423A18/9	\$124.95 ^{SE}
68	Satin	CSZZ-76423A18/9S	\$124.95 ^{SE}

CONVERTIBLE VISOR PIVOT ARM



Easy repair kit for those of you who want an economical fix.

Year	Part No.	List
64-66	CSZZ-7604144-P	\$18.95 ^{PR}

CONVERTIBLE VISOR ROD



Chrome plated 4-piece kit. Pushes into padded sun visors.

Year	Part No.	List
64-66	CSZZ-7604114-K	\$12.95 ^{KI}

CONVERTIBLE SUN VISOR

Convertible visors are covered in the original Sierra Grain vinyl.



Year	Description	Part No.	List
65-66	Aqua	CSZZ-7604104-AQ	\$49.95 ^{PR}
64-66	Black	CSZZ-7604104-BK	\$49.95 ^{PR}
64-65	Medium blue	CSZZ-7604104-BL	\$49.95 ^{PR}
64-65	Bright red	CSZZ-7604104-BR	\$49.95 ^{PR}
66	Dark red	CSZZ-7604104-DR	\$49.95 ^{PR}
64-66	Emberglo	CSZZ-7604104-EM	\$49.95 ^{PR}
64-66	Ivy gold	CSZZ-7604104-IG	\$49.95 ^{PR}
66	Light blue	CSZZ-7604104-LB	\$49.95 ^{PR}
64-66	Palamino	CSZZ-7604104-PA	\$49.95 ^{PR}
66	Parchment	CSZZ-7604104-PR	\$49.95 ^{PR}
64-66	Turquoise	CSZZ-7604104-TQ	\$49.95 ^{PR}
64-66	White	CSZZ-7604104-WT	\$49.95 ^{PR}
67-68	Aqua	C7ZZ-7604104-AQ	\$49.95 ^{PR}
67-68	Black	C7ZZ-7604104-BK	\$49.95 ^{PR}
67-68	Dark blue	C7ZZ-7604104-DB	\$49.95 ^{PR}
67-68	Dark red	C7ZZ-7604104-DR	\$49.95 ^{PR}
67-68	Ivy gold	C7ZZ-7604104-IG	\$49.95 ^{PR}
67-68	Light blue	C7ZZ-7604104-LB	\$49.95 ^{PR}
68	Maroon	C7ZZ-7604104-MR	\$49.95 ^{PR}
68	Nugget gold	C7ZZ-7604104-NG	\$49.95 ^{PR}
67-68	Parchment	C7ZZ-7604104-PR	\$49.95 ^{PR}

Year	Description	Part No.	List
67-68	Saddle	C7ZZ-7604104-SA	\$49. ⁹⁵ PR
67-68	White	C7ZZ-7604104-WT	\$49. ⁹⁵ PR
69-73	Black	C9ZZ-7604104-BK	\$49. ⁹⁵ PR
69-73	Blue	C9ZZ-7604104-BL	\$49. ⁹⁵ PR
69-73	Dark ivy	C9ZZ-7604104-DI	\$49. ⁹⁵ PR
69-73	Dark red	C9ZZ-7604104-DR	\$49. ⁹⁵ PR
69-73	Green	C9ZZ-7604104-GR	\$49. ⁹⁵ PR
69-73	Ivy gold	C9ZZ-7604104-GR	\$49. ⁹⁵ PR
69-73	Light blue	C9ZZ-7604104-LB	\$49. ⁹⁵ PR
69-73	Nugget gold	C9ZZ-7604104-LN	\$49. ⁹⁵ PR
69-73	Parchment	C9ZZ-7604104-PR	\$49. ⁹⁵ PR
69-73	Vermillion	C9ZZ-7604104-VE	\$49. ⁹⁵ PR
69-73	White	C9ZZ-7604104-WT	\$49. ⁹⁵ PR

REAR WINDOWS

GLASS CONVERTIBLE TOP REAR WINDOW



Glass rear windows greatly enhance rear visibility. They are not prone

to scratching, cracking or yellowing due to exposure to the sun.



Year	Description	Part No.	List
64-66	Black	C5ZZ-7652500-GB	\$209. ⁹⁵ EA
64-66	White	C5ZZ-7652500-GW	\$209. ⁹⁵ EA
67-70	Black	C7ZZ-7652500-GB	\$209. ⁹⁵ EA
67-70	White	C7ZZ-7652500-GW	\$209. ⁹⁵ EA
69-70	White	C9ZZ-7652500-GW	\$199. ⁹⁵ EA
71-73	Black	D1ZZ-7652500-GB	\$204. ⁹⁵ EA
71-73	White	D1ZZ-7652500-GW	\$204. ⁹⁵ EA

PLASTIC CONVERTIBLE TOP REAR WINDOW



Plastic windows feature heavy duty 40 gauge clear plastic trimmed with premium 38 ounce material and a zipper assembly.



Year	Desc	Part No.	List
64-66	Black	C5ZZ-7652500-PB	\$122. ⁹⁵ EA
64-66	White	C5ZZ-7652500-PW	\$122. ⁹⁵ EA
67-68	Black	C7ZZ-7652500-PB	\$154. ⁹⁵ EA
67-68	White	C7ZZ-7652500-PW	\$154. ⁹⁵ EA
71-73	Black	D1ZZ-7652500-PB	\$114. ⁹⁵ EA
71-73	White	D1ZZ-7652500-PW	\$114. ⁹⁵ EA

TOPS, PADS & TACK STRIPS

CONVERTIBLE TACK STRIP



Bulk Conv Tack Strip/50 FT roll. Fits front bow and #4 bow only.

Year	Description	Part No.	List
64-73	50 ft roll	C5ZZ-76-TS-BULK	\$92. ⁵⁰ RL
64-73	55" strip	C5ZZ-76521278-T	\$12. ⁵⁰ EA

CONVERTIBLE TOP PAD



Quality construction. Used to cushion and protect top vinyl from excessive wear from side rails.

Year	Description	Part No.	List
64-68	Black	C5ZZ-7652875-BK	\$48. ⁹⁵ SE
69-70	Black	C9ZZ-7652875-BK	\$48. ⁹⁵ SE
71-73	Black	D1ZZ-7652875-BK	\$48. ⁹⁵ SE

CONVERTIBLE TOP REAR TACK STRIP KIT

Metal tack strip complete with special cardboard insert for proper staple fastening.



Year	Description	Part No.	List
64	Rear	MM-043	\$139. ⁹⁵ SE
65-66	Rear	MM-143	\$139. ⁹⁵ SE
67-68	Rear	MM-243	\$139. ⁹⁵ SE
69-70	Rear	MM-343	\$169. ⁹⁵ EA
71-73	Rear	MM-443	\$169. ⁹⁵ EA

CONVERTIBLE TOP WITH GLASS BACK WINDOW



Glass rear windows enhance rear visibility. They are not prone to scratching, cracking, or yellowing due to sun exposure. Robbins heat-seals glass into glass window assemblies using the same equipment and techniques as Ford and other OEM convertible manufacturers. They do not use inferior methods that produce weak bonds, such as gluing them with silicon. All of our tops feature: Assembled header-bow bulb seal, specially treated vinyl to resist mildew, 3 year pro-rated warranty, coated vinyl for extra waterproofing, factory original pinpoint grain, heavy duty YKK nylon zipper, includes wire-on feature strip with stainless tips and screws, and meets motor vehicle fire retardant requirements. Stock colors are black and white, however we can special order Tan, Dark Blue, Brown, and Saddle. Special Order colors are non-returnable and have a \$30 upcharge. 1964-70 rear windows feature Robbins patented "Flex-Hinge" folding seam. 1971-73 are solid glass. 1964-66 must use convertible well liner part number WL-FM-67-BK. Glass rear window and top are packaged in a single box for reduced shipping cost.



Year	Description	Part No.	List
64-66	Black	C5ZZ-7652701-BR	\$459. ⁹⁵ EA
64-66	White	C5ZZ-7652701-WR	\$459. ⁹⁵ EA
67-68	Black	C7ZZ-7652701-BR	\$459. ⁹⁵ EA
67-68	White	C7ZZ-7652701-WR	\$459. ⁹⁵ EA
69-70	Black	C9ZZ-7652701-BR	\$459. ⁹⁵ EA
69-70	White	C9ZZ-7652701-WR	\$459. ⁹⁵ EA
71-73	Black	D1ZZ-7652701-BR	\$459. ⁹⁵ EA
71-73	White	D1ZZ-7652701-WR	\$459. ⁹⁵ EA

Convertible

WE PROUDLY FEATURE AUTHENTIC MUSTANG REPRODUCTIONS FROM SCOTT DRAKE!



CV TOP W/ GLASS BACK WINDOW



Glass rear windows greatly enhance rear visibility. They are not prone to scratching, cracking or yellowing due to exposure to

the sun. 1964 - 1970 rear windows have a visible urethane folding seam. 1971 - 1973 are solid glass. 1964 - 1966 must use 67 - 70 convertible well liner. 1964 - 1970 folding seam carries an 18 month warranty against splitting or separation. Glass rear window and top are now packaged in 1 box to save on shipping cost

Year	Description	Part No.	List
64-66	Black	CSZZ-7652701-PB	\$414 ⁹⁵ EA
64-66	White	CSZZ-7652701-PW	\$414 ⁹⁵ EA
67-68	Black	C7ZZ-7652701-PB	\$404 ⁹⁵
67-68	White	C7ZZ-7652701-PW	\$404 ⁹⁵ EA
69-70	Black	C9ZZ-7652701-PB	\$404 ⁹⁵ A
69-70	White	C9ZZ-7652701-PW	\$404 ⁹⁵ EA
71-73	Black	D1ZZ-7652701-PB	\$404 ⁹⁵ EA
71-73	White	D1ZZ-7652701-PW	\$404 ⁹⁵ EA

CV TOP W/ PLASTIC BACK WINDOW



Robbins tops are manufactured using OEM quality vinyl from Haartz, which is

specially treated vinyl to resist mildew. They feature heat-sealed reinforcements for added strength and to prevent shrinkage in panels. Although gluing is faster and cheaper, glued reinforcements often bubble or fail over time. Heat-sealed reinforcements don't. Plastic window is made using the same Haartz vinyl, and OEM quality 40 gauge clear PVC. Stock colors are black and white, however we can special order Tan, Dark Blue, Brown, and Saddle. Special Order colors are non-returnable and have a \$30 upcharge. All of our tops feature: Assembled header-bow bulb seal, 3 year pro-rated warranty, factory original pinpoint grain, heavy duty YKK nylon zipper. Original brass zipper available as a special order, upcharge \$40. Includes wire-on feature strip with stainless tips and screws. Meets motor vehicle fire retardant requirements.

Year	Description	Part No.	List
64-66	Black	CSZZ-7652700-PB	\$299 ⁹⁵ EA
64-66	White	CSZZ-7652700-PW	\$299 ⁹⁵ EA
67-68	Black	C7ZZ-7652700-PB	\$299 ⁹⁵ EA
67-68	White	C7ZZ-7652700-PW	\$299 ⁹⁵ EA
69-70	Black	C9ZZ-7652700-PB	\$309 ⁹⁵ EA
69-70	White	C9ZZ-7652700-PW	\$309 ⁹⁵ EA
71-73	Black	D1ZZ-7652700-PB	\$309 ⁹⁵ EA
71-73	White	D1ZZ-7652700-PW	\$309 ⁹⁵ EA

WEATHER SEALS

CONVERTIBLE PILLAR SEAL

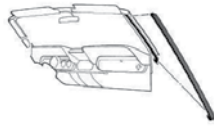

Superior quality E.P.D.M. sponge rubber with transfer molded ends.

Year	Desc	Part No.	List
64-68	RH & LH	CSZZ-7602626/7D	\$26 ⁹⁵ PR
69-70	RH	C9ZZ-7602626-A	\$129 ⁹⁵ EA
69-70	LH	C9ZZ-7602627-A	\$129 ⁹⁵ EA
71-73	RH & LH	D1ZZ-7602626/7A	\$84 ⁹⁵ PR

CV TOP HEADER TO WINDSHIELD SEAL



We offer this separately, for customers wanting to replace header only.

Same quality as our complete kit.

Year	Part No.	List
64-68	CSZZ-7653986-H	\$45 ⁰⁰ EA
71-73	D1ZZ-7651325-A	\$14 ⁹⁵ EA

CONVERTIBLE TOP SEAL KIT



The smart choice for the informed Mustang enthusiast. Our kit is the best, guaranteed! Don't be fooled by poor quality imitations. Comes with installation instructions. Note: Hardware not included. See kits 379361-SK & 351320-SK.

Year	Part No.	List
64-68	CSZZ-7653986-K	\$99 ⁹⁵ KI
69-70	C9ZZ-7653986-K	\$164 ⁹⁵ SE
71-73	D1ZZ-7653986-K	\$229 ⁹⁵ KI

CONVERTIBLE TOP SEAL TUBE NUT SET



A very special hex tube nut that we tooled. Zinc plated.

Year	Description	Part No.	List
64-68	Set of 16	379361-SK	\$12 ²⁵ KI

CONVERTIBLE TOP SEAL WASHER SET



Exact copy, not an off the shelf generic washer. Washer is exact size and thickness.

Year	Description	Part No.	List
64-68	Set of 16	351320-SK	\$6 ⁹⁵ SE

WELL LINERS

WELL LINER



Our well liners fit correctly. Made of heavy duty, textured vinyl. **NOTE: Customers who have a 1964-1966 glass rear window will need to use a 1967-1968 well liner.**

Year	Description	Part No.	List
64-66	Black	WL-FM-65-BK	\$34 ⁹⁵ EA
64-66	White	WL-FM-65-WT	\$34 ⁹⁵ EA
67-68	Black	WL-FM-67-BK	\$34 ⁹⁵ EA
67-68	White	WL-FM-67-WT	\$34 ⁹⁵ EA
69-70	Black	WL-FM-69-BK	\$34 ⁹⁵ EA
69-70	White	WL-FM-69-WT	\$34 ⁹⁵ EA
71-73	Black	WL-FM-71-BK	\$34 ⁹⁵ EA
71-73	White	WL-FM-71-WT	\$34 ⁹⁵ EA

WELL LINER MOUNTING SET



An 11 pc. set of flat/ phillips head screws to attach the well liner on convertibles.

Year	Part No.	List
64-68	377948-SMK	\$3 ⁹⁵ SE

WELL LINER TENSIONING SPRING



Keeps the convertible well liner taut. Short version pictured.

Year	Description	Part No.	List
64-66	Long version	CODB-6461883-B	\$8 ⁹⁵ PR
64-66	Short version	CODB-6461883-C	\$8 ⁹⁵ PR

COOLING SYSTEM

COOLANT CIRCULATION

DATE STAMPED

RADIATOR & HEATER HOSE CLAMP SET



A must for any show, Scott Drake Radiator Hose Clamp Sets, with stamped date codes! These galvanized hose clamps

are an authentic reproduction, each clamp is stamped with the correct date code. Sold in a convenient set of 10. These are Wittek concours correct.

Year	Description	Part No.	List
64-65	6 Cyl, Stamped w/"2/64"	CSZZ8287-6 2-64	\$21 ⁹⁵ SE
67-68	6 Cyl, Stamped w/"4/66"	CSZZ8287-6 4-66	\$21 ⁹⁵ SE
64-65	V8, Stamped w/"2/64"	CSZZ8287-8 2-64	\$21 ⁹⁵ SE
65-66	V8, Stamped w/"2/65"	CSZZ8287-8 2-65	\$21 ⁹⁵ SE
67-68	Sm. block, Stamped w/"4/66"	CSZZ8287-8 4-66	\$21 ⁹⁵ SE

NON-DATED

RADIATOR & HEATER HOSE CLAMP SET



Original type post style clamps for big blocks.

Year	Description	Part No.	List
67-70	390, 428	CSZZ-8287-CK	\$22 ⁹⁵ SE

RADIATOR COOLANT FILTER

This filter is designed to be installed in the upper radiator hose. Installation of the "Full Flow" filter will stop radiator and heater core clogging due to rubber from hoses, foreign particles and rust scale. Filter is transparent and can easily be cleaned. Also available in a high performance brass version.



Year	Description	Part No.	List
64-73	6 cyl, transparent	ACC-GANO-6	\$22 ⁹⁵ EA
64-73	8 cyl, transparent	ACC-GANO-8	\$22 ⁹⁵ EA



64-73: 6 cylinder, high performance, brass
ACC-GANO-6B

List
\$69 ⁹⁵ KI



64-73
8 cylinder, aluminum
ACC-GANO-8A

List
\$54 ⁹⁵ EA



64-73
8 cylinder, high performance, brass
ACC-GANO-8B

List
\$59 ⁹⁵ EA



64-73
Standard heater hose
ACC-GANO-HTR

List
\$38 ⁹⁵ KI

CONCOURS RADIATOR HOSE SET



These are the best concours radiator hoses on the market. New improved stamping will not come off even when in contact with

antifreeze. All have imprints that are very crisp and authentic. Each imprint is concours correct for the specific application year. Represented by an oval FoMoCo, rectangle FoMoCo, Autolite logo or Motorcraft.



Year	Description	Part No.	List
64-65	260, 289 & 289 hi-po	C4ZE-8260/86-A*	\$27 ⁹⁵ PR
64-70	170 & 200	C4ZE-8260/86-B*	\$29 ⁹⁵ PR
67	390, 427 & 428	C60E-8260/86-A*	\$29 ⁹⁵ PR
66	289 & 289 hi-po	C6ZE-8260/86-B*	\$27 ⁹⁵ PR
67	289 & 289 hi-po	C7ZE-8260/86-A*	\$27 ⁹⁵ PR
68	390, 427, 428 & 428 Cobra Jet	C8ZE-8260/86-C*	\$29 ⁹⁵ EA
68	289 & 302	C8ZE-8260/86-E	\$27 ⁹⁵ PR

GENERIC RADIATOR HOSE SET



Same quality as our concours radiator hose sets, but without logos and part numbers. Great for daily drivers.

Year	Description	Part No.	List
64-68	Small block	C4ZE-8260/86-G	\$21 ⁹⁵ KI

RADIATOR CAPS

RADIATOR CAP



These concours quality caps are made in America and bear all the original markings. O.E.M. details include original letter style, "S.M.C.O." and "Autolite". Pound rating is stamped on cap.

Year	Description	Part No.	List
64-66	SMCO CON Radiator cap (zinc plated)	CSZZ-8100-A	\$14 ⁹⁵ EA
64-66	SMCO CON Radiator cap (chrome plated)	CSZZ-8100-AC	\$14 ⁹⁵ EA
67-71	Autolite Radiator cap (zinc plated)	C7ZZ-8100-A	\$18 ⁹⁵ EA
67-71	Autolite Radiator cap (chrome plated)	C7ZZ-8100-AC	\$18 ⁹⁵ EA
65-73	Motorcraft, 2-ear design, (bright zinc plated) limited	C9ZZ-8100-A*	\$14 ⁹⁵ EA

WE PROUDLY FEATURE AUTHENTIC MUSTANG REPRODUCTIONS FROM SCOTT DRAKE!



SILICONE RADIATOR HOSE SET



Black silicone radiator hose set, includes bypass hose. Nylon reinforced lower hose has stainless steel spring. Silicone lasts longer and has a higher burst strength. Small block V8.

Year	Description	Part No.	List
64-68	289,302	CSZE-8260/86-BK	\$69.95 ^{SE}

SHELBY RADIATOR HOSE SET



Officially Licensed by Shelby, this 1965-68 Shelby Radiator Hose Set from Scott Drake features our quality rubber with the Shelby name and part number imprint.



Year	Part No.	List
65-68	S1MS-8260/86-S	\$34.95 ^{SE}

CONCOURS RADIATOR HOSE SET WITH WIRE CLAMPS



These are the best concours radiator hoses on the market. New improved stamping will not come off even when in contact

with antifreeze. All have imprints that are very crisp and authentic. Each imprint is concours correct for the specific application year. Represented by an oval FoMoCo, rectangle FoMoCo, Autolite logo or Motorcraft. All feature wire clamps stapled to hoses.



Year	Description	Part No.	List
68	390, 427, 428 & 428 Cobra Jet	C8ZE-8B273/4-D*	\$49.95 ^{PR}
69-70	390,428 & 428 Cobra jet	C9AE-8B273/4-E*	\$49.95 ^{PR}
69-70	Boss 429 (upper only)	C9AE-8B273/4-F*	\$89.95 ^{EA}
69-70	250 6 cylinder	C9ZE-8B273/7-A*	\$54.95 ^{PR}
69	302, Boss 302 & 351W	C9ZE-8B273/7-B*	\$49.95 ^{PR}
69	302, 351W 20"	C9ZE-8B273/7-C*	\$49.95 ^{PR}
70	302, Boss 302 & 351W	D0ZE-8B273/4-B*	\$49.95 ^{PR}
70	351 Cleveland	D0ZE-8B273/4-C*	\$54.95 ^{PR}
71	302	D1AE-8B273/4-A*	\$54.95 ^{PR}
71	351 Cleveland	D1AE-8B273/4-DA*	\$54.95 ^{PR}
71	429	D10E-8B273/4-BA*	\$54.95 ^{PR}
72-73	302	D2AE-8B273/4-A*	\$54.95 ^{PR}
72-73	351 Cleveland	D2AE-8B273/4-DA*	\$54.95 ^{PR}

WATER BYPASS HOSE



Officially By-pass hose with original Ford/Motorcraft markings.



Year	Description	Part No.	List
64-66	FoMoCo logo	C2DZ-8597-A	\$34.95 ^{EA}
67-71	Autolite logo	C7OZ-8597-A	\$34.95 ^{EA}
69-71	Autolite logo, dual diameter	C90E-8597-D	\$7.50 ^{EA}
72-73	Motorcraft logo, dual diameter	D20E-8597-D	\$6.95 ^{EA}

STOCK WATER PUMP



These all new pumps are the most logical way to end water pump problems. Gaskets are included with each pump.

Year	Description	Part No.	List
64-65	260,289 cast aluminum	CSAZ-8501-K	\$89.95 ^{EA}
66-69	Small block, cast iron	C50Z-8501-H	\$64.95 ^{EA}
67-70	390, 427, 428 Cobra Jet	C8AZ-8501-A	\$69.95 ^{EA}
70-73	351 Cleveland	D0AZ-8501-E	\$84.95 ^{EA}
70-73	302, Boss 302, 351W	D00Z-8501-A	\$64.95 ^{EA}

HI-PO WATER PUMP



Built to cool better and last longer than any other pump built today. Features high efficiency impeller

and NASCAR roller type bearing. Both small blocks are aluminum units, but C50Z-8501-HPA replaces stock cast-iron unit.

Year	Description	Part No.	List
63-65	Small block, high performance, high flow	C30Z-8501-HPA	\$144.95 ^{EA}
66-69	Small block, high performance, high flow	C50Z-8501-HPA	\$144.95 ^{EA}

WATER PUMP BOLT KIT



These bolts are exact copies. Feature correct head markings and lengths. Includes detailed instructions for the position of each bolt.

Year	Description	Part No.	List
67-70	390, 428	WPB-B8AE-497	\$6.95 ^{KI}
64-70	170,200	WPB-C0DE-498	\$3.95 ^{KI}
65	289, w/out AC	WPB-C2OE-388	\$24.95 ^{KI}
64	260, 289, w/out AC	WPB-C2OE-487	\$24.95 ^{KI}
64	260, 289, w/ AC	WPB-C2OE-491	\$24.95 ^{KI}
65	289, w/ AC	WPB-C5OE-492	\$28.95 ^{KI}
66	289, 302, w/ AC	WPB-C6OE-242	\$22.95 ^{KI}
66-68	289, 302, w/out AC	WPB-C6OE-304	\$22.95 ^{KI}
67	289, w/ AC	WPB-C7OE-249	\$22.95 ^{KI}
68	289, 302, w/ AC	WPB-C8OE-305	\$22.95 ^{KI}
71	429	WPB-C8SE-1499	\$16.50 ^{KI}
69-73	250	WPB-C9DE-558	\$13.95 ^{KI}
69	302, 351W, Boss 302, w/out AC	WPB-C9OE-307	\$22.95 ^{KI}
69	302, 351W, w/ AC	WPB-C9OE-308	\$22.95 ^{KI}
70-73	302, 351W, Boss 302	WPB-D0OE-306	\$25.95 ^{KI}
70-73	351 Cleveland	WPB-D0OE-309	\$25.95 ^{KI}

FAN SHROUD AND FAN

FAN CLUTCH



Mustang Fan Clutch Assembly, which resembles the original Ford units. NOTE: Will fit most, but not all applications. Not concours.

Year	Description	Part No.	List
66-73	Fan Clutch, SB	C60Z-8A616-A	\$32.95 ^{EA}
68-69	Fan Clutch, 390	C80E-8A616-R	\$49.95 ^{EA}
69-70	Fan Clutch, 428	C9ZE-8A616-R	\$54.95 ^{EA}

CLUTCH FAN BOLT



4 piece set.

Year	Part No.	List
66-73	C50E-1804	\$6.95 ^{SE}

CAUTION FAN DECAL

CAUTION-FAN Decal placed on the fan shroud to remind you to keep all ten of your fingers. Great idea for all years.

Year	Part No.	List
68-69	DF-31	\$3.50 ^{EA}

ELECTRIC FAN AND SHROUD KIT

This kit increases cooling capabilities especially at idle and low RPM. Tired of overheating in traffic? This easy to install kit is not a universal kit. It is made specifically to fit Scott Drake 259 radiators. No extra holes to drill. Also improves horsepower and economy. Instructions included. C3DZ-8146/8600H pictured.



Year	Description	Part No.	List
64-66	Electric Fan and Shroud for copper/brass radiators	C3DZ-8146/8600H	\$324. ⁹⁵ KI

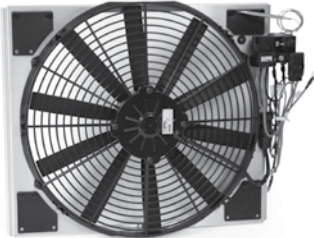

Keep your Mustang running cool with this electric fan shroud kit designed specifically to fit Scott Drake 259 series aluminum 2-row radiators. This kit is built around a high performance 16" Spal 10 straight blade fan rated at 1650 CFM. Strategically placed pass-through flaps at each corner allow increased air flow at cruising speeds for maximum efficiency. Shroud and fan thickness is 3 1/4". Fan amp draw: 11amps. Kit includes: wiring harness, relay, and an adjustable thermostatic switch neatly mounted to the shroud on powder coated brackets.

Year	Description	Part No.	List
64-66	Electric Fan and Shroud Kit for Aluminum Radiators	C3DZ-8146/8600H	\$324. ⁹⁵ KI



1967-69 Mustang Premium 20 inch Electric Fan and Shroud that will not 340-4 or 340-2AL.

Year	Description	Part No.	List
67-69	289, 302 w/o AC 20"	C7ZZ-8146/8600	\$329. ⁹⁵ KI

FAN BLADE



17 inch diameter fan improves cooling over standard 4-blade versions. Original equipment on some AC cars. Painted

black. Not compatible with clutch fan assembly. Concours correct big block version must be used with clutch fan assembly.

Year	Description	Part No.	List
65-70	5 Blade	C5ZZ-8600-C	\$68. ⁹⁵ EA
64-73	6 Blade	C6ZZ-8600-C	\$69. ⁹⁵ EA
68-69	390, Concours	C80E-8600-B*	\$239. ⁹⁵ EA
69-70	428 CJ, Concours	C9ZE-8600-E*	\$249. ⁹⁵ EA

HI-PO FAN BLADE



Exact copy of the fan blade used on early Shelby's and "K" HiPo cars.

Year	Description	Part No.	List
64-73	Four blade, High performance	C5ZZ-8600-HP	\$149. ⁹⁵ EA

ORIGINAL FAN SHROUD



An absolute must to keep you car running cool and efficient in Original steel, ABS or fiberglass.

Year	Description	Part No.	List
64-66	Small block, original steel	C3DZ-8146-DR	\$29. ⁹⁵ EA
67	Big block, fiberglass, 24"	C7ZZ-8146-A	\$139. ⁹⁵ EA
68-70	Big block, 24", will fit 67	C8ZZ-8146-A	\$84. ⁹⁵ EA
68-69	Small block w/ AC, 24"	C90Z-8146-A	\$72. ⁵⁰ EA
67-69	Small block w/out AC, 20"	C9ZZ-8146-BR	\$49. ⁹⁵ EA
70	302 and 351 w/ AC, 24"	D0ZZ-8146-A	\$114. ⁹⁵ EA
70	302 and 351 w/out AC, 20"	D0ZZ-8146-B	\$74. ⁹⁵ EA
71-73	302 and 351 w/ AC	D1ZZ-8146	\$129. ⁹⁵ EA

HI-PO FAN SHROUD



These are almost twice as wide as original shrouds to improve cooling performance.

Year	Description	Part No.	List
64-66	ABS plastic 3-1/2" wide	C3DZ-8146-3	\$82. ⁹⁵ EA
64-66	Fiberglass 3-1/2" wide	C3DZ-8146-3F	\$104. ⁹⁵ EA

FAN SHROUD BRACKET



Now made by Scott Drake. Steel brackets with a dull black finish. Mounting hardware included.

Year	Description	Part No.	List
64-66	2 core	C3DZ-8149-2	\$12. ⁹⁵ SE
64-66	3 core	C3DZ-8149-3	\$15. ⁹⁵ KI
64-66	4 core	C3DZ-8149-4	\$15. ⁹⁵ KI

FAN SPACERS

Now Our fan spacers are available in different finishes and styles. Including our concours correct "K" HiPo and Shelby version. These shorter spacers are usually required when running larger radiators. Requires Fan Spacer Bolts part #379205-K.

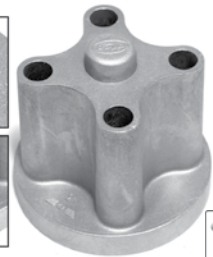

Year	Description	Part No.	List
65-66	OE, HiPo 289 w/ logo, 2.125"	C30Z-8546-A*	\$49. ⁹⁵ EA
64-73	Natural finish, no logo, 2.25"	C4AZ-8546-A	\$19. ⁹⁵ EA
64-73	Polished, no logo, 2.25"	C4AZ-8546-P	\$24. ⁹⁵ EA

EXTRA SHORT FAN SPACERS



Extra short 1.5" fan spacer is required on some small blocks and all big blocks when using a thicker, 2 row, aluminum, or 4 core copper/brass radiators for proper fan clearance. Fits

most 6 cylinder as well with stock radiators. Will not fit cars with fan clutch assembly. Natural or Polished.

Year	Description	Part No.	List
64-73	NEW Polished, no logo, 1.5"	C4AZ-8546-P	\$24. ⁹⁵ EA
64-73	NEW Natural finish, no logo, 1.5"	C4AZ-8546-A	\$19. ⁹⁵ EA

FAN SPACER BOLT KIT



This fan bolt kit will fit either 2 1/8" or 2 1/4" spacers. Not concours.

Year	Description	Part No.	List
64-73		379205-K	\$3. ⁹⁵ KI

WE PROUDLY FEATURE AUTHENTIC MUSTANG REPRODUCTIONS FROM SCOTT DRAKE!



BILLET RADIATOR CAP



Another custom billet aluminum product from Scott Drake. We made a clear anodized aluminum top and mated it with a stock Motorcraft™ cap. See Engine section for

matching caps!

Year	Description	Part No.	List
64-73	Billet	B-8100	\$36 ⁹⁵ EA

RADIATOR CAP W/ ELECTROLYSIS PROTECTION



A special radiator cap that includes a sacrificial magnesium anode that protects aluminum and other soft material engine components from electrolysis. Electrolytic Metal Erosion (EME) is slowly destroying your engine components. EME attacks timing chain covers, radiators, heater cores, intake manifolds, freeze plugs, head gaskets, thermostat housings even cylinder heads causing premature failures. By allowing EME to attack the sacrificial anode, the "Rad Cap" protects your engine while driving or in storage.

Year	Description	Part No.	List
64-73	W/ sacrificial anode	CSZZ-8100-RC-E	\$16 ⁹⁵ EA

RADIATOR MOUNTING

RADIATOR INSULATOR



Made from E.P.D.M. rubber, molded just like the original.

Year	Description	Part No.	List
67	Lower	C3AZ-8125-A	\$9 ⁹⁵ PR
68-70	Lower	C8ZZ-8125-A	\$9 ⁹⁵ PR
68-70	Lower & Upper 2 row (Alum) radiators	C8ZZ-8125-B	\$11 ⁹⁵ PR
67-68	Upper, 2 row	C70Z-8124-A	\$9 ⁹⁵ PR
67-68	Upper, 3 row	C70Z-8124-A3	\$11 ⁹⁵ PR
67-68	Upper, 4 row	C70Z-8124-A4	\$11 ⁹⁵ PR
71-73	Lower & Upper	D1ZZ-8124	\$26 ⁹⁵ SET

RADIATOR MOUNTING BRACKET



These Brackets are made by Scott Drake from stamped steel just like the original, and built following Ford prints for an exact fit. Available in correct OEM Black (like the original), or in a highly-polished stainless steel for customers looking for a little more flash under the hood! 1967 lower OEM black, fits original radiators only. For aftermarket radiators use C8ZZ-8052-A or C8ZZ-8052-B.

Year	Description	Part No.	List
67	Lower, OEM black	C7ZZ-8052-A	\$12 ⁹⁵ PR



Year	Description	Part No.	List
68-70	Lower, OEM black will fit 1967. Will fit 1967 but requires drilling hole into strut brace	C8ZZ-8052-A	\$12 ⁹⁵ PR
68-70	Lower, 2 row aluminum radiator. Will fit 1967 but requires drilling hole into strut brace	C8ZZ-8052-B	\$12 ⁹⁵ PR



Year	Description	Part No.	List
67-68	Upper OEM black	C7ZZ-8A193-A	\$12 ⁹⁵ PR
69-70	Upper OEM black	C9ZZ-8A193-A	\$12 ⁹⁵ PR



Year	Description	Part No.	List
67-68	Upper OEM polished stainless	C7ZZ-8A193-S	\$12 ⁹⁵ EA
69-70	Upper OEM polished stainless	C9ZZ-8A193-S	\$12 ⁹⁵ EA



New from Scott Drake, our 1967-1970 Upper Radiator Mount Bracket for 24"

radiators feature stamped and formed aluminum construction with a brushed and clear anodized finish. Scott Drake's Radiator Insulators and Mount Brackets are specifically designed for our High Performance Radiators (379-2AL and 338-2AL). For a hassle free installation, our upper Radiator Mount Insulators are also required (C8ZZ-8125-B).

Year	Description	Part No.	List
67-68	Aluminum radiators	C7ZZ-8A193-AL	\$44 ⁹⁵ EA
69-70	Aluminum radiators	C9ZZ-8A193-AL	\$44 ⁹⁵ EA

RADIATOR MOUNTING KIT



Black oxide finish to prevent rust. Kit includes four washer bolts and four "J" nuts. (Not for saddle mount radiators).

Year	Part No.	List
64-68	CSZZ-8005-MK	\$5 ⁹⁵ KI

RADIATOR OVERFLOW TANK KIT



Tank is an extruded aluminum tank with a machined cap affixed with our popular carbon fiber pattern emblem insert, to match our line of Classic Mustang Engine Caps. Includes aluminum mounting clamps with stainless steel hardware.

Part No.	Year	List
C5ZZ-8C077-AL	65-68	\$99 ⁹⁵ EA

RADIATOR OVERFLOW HOSE



Maintain true authenticity with this 1964-73 Mustang and 1966-77 Bronco Radiator Overflow Hose by Scott Drake. This factory correct hose features 3 raised ribs, just like original, and is 36" in length. Some radiators may require the hose to be trimmed to the proper length.

Year	Part No.	List
64-73	C2AZ-9324-C	\$9 ⁹⁵ EA

RADIATOR DRAIN VALVE



These are O.E.M. replacements and will not fit most after market radiators.

Year	Part No.	List
64-73	8A-8115	\$6 ⁹⁵ EA

RADIATORS

HIGH PERFORMANCE, ALUMINUM, 2 CORE RADIATOR

New by Drake! These 2-row aluminum radiators feature extra large 1" tubes to equal 4 row efficiency, but with 5-7 lbs less weight. Benefit from improved performance through modern technology. Concours correct radiator overflow hose available separately under part number C2AZ-9324-C.



64-66
170, 200 6 cyl w/trans cooler
251-2AL

List
\$294⁹⁵ EA



64-66
260, 289 V8, w/trans cooler
259-2AL

List
\$289⁹⁵ EA



64-66
Late Model 5.0, manual trans.
259-2AL-LM

List
\$294⁹⁵ EA



64-66
Manual trans
259-2AL-MT

List
\$289⁹⁵ EA



67-69
289, 302, 351W, With trans
cooler 20"
340-2AL

List
\$289⁹⁵ EA



67-69
289, 302 & 351W 24"
338-2AL

List
\$339⁹⁵ EA



70
302 & 351C 20"-OR-67-69:w/
Late Model 5.0
339-2AL

List
\$294⁹⁵ EA



68-70
390, 428 (also fits 70 302, 351),
w/trans cooler, 24", mounting
bracket modification required
379-2AL

List
\$339⁹⁵ EA

SHELBY ALUMINUM RADIATOR



Scott Drake's new 1965-66 Mustang performance aluminum radiator is a fantastic upgrade to your OEM radiator.

This official Shelby product is engineered with an upper internal baffle that improves coolant distribution for optimized cooling efficiency. Our radiators are constructed from aircraft-quality aluminum and feature a fully TIG welded tank. Comes with an integrated automatic transmission cooler that ensures your fluid and components are working to their peak potential. Includes a die cast chrome plated Shelby emblem on the tank and a black Shelby logo across the front fins



Year	Part No.	Description	List
65-66	S1MS-259-2AL	A/T	\$319 ⁹⁵ EA
65-66	S1MS-259-2AL-MT	Shelby-289/302 MT	\$319 ⁹⁵ EA
67-68	S7MS-340-2AL	Shelby-289/302	\$319 ⁹⁵ EA

1964½-66 MUSTANG V8 PREMIUM 3-CORE, COPPER / BRASS RADIATOR



Get improved cooling efficiency while maintaining the look of original equipment with new Scott Drake premium 3-core copper / brass radiators for 1964.5-66 Mustangs with small block V8's. These high performance radiators are designed to provide superior thermal transfer compared to standard 2 core units. They feature durable copper / brass construction and a high capacity 3 row internal design for long lasting performance. These radiators also include an integrated automatic transmission cooler, an over-flow tube routed off of the upper fill neck, and a petcock drain off the lower tank for easy set up and maintenance. These radiators are designed specifically for 64½-66 Mustangs with 260, 289 and early 302 engines.

Year	Description	Part No.	List
64½-66	260, 289, & early 302 engines	259-3P	\$249 ⁹⁵ EA

USA 3 CORE RADIATOR



Made in the USA with a full 1 year warranty (Limited to repair or replacement), molded foam for optimum shipping protection,

all radiators are 100% pressure tested by manufacturer, meets or exceeds original equipment specifications, long lasting satin black finish, all copper/brass core construction which resists corrosion, state of the art multi-louvered fin design which delivers maximum air flow & cooling. Note: Warranty does not include removal/installation labor or return shipping. Drain valve 8A-8115 sold separately.

Year	Description	Part No.	List
64-66	170, 200 6 cylinder	251-3	\$369 ⁹⁵ EA
64-66	260, 289	259-3	\$324 ⁹⁵ EA
67-69	200 6 cylinder	329-3	\$324 ⁹⁵ EA
67-69	289, 302, 351 w/ AC, 24" **	338-3	\$394 ⁹⁵ EA
67-69	289, 302, 351 w/out AC, 20"	340-3	\$369 ⁹⁵ EA
70	302, 351 w/out AC, 20"	340-3C	\$379 ⁹⁵ EA
67-70	67-70: 390, 428 70: 302, 351 w/ AC, 24"	379-3	\$399 ⁹⁵ EA
71-73	302, 351, 429	381-3	\$419 ⁹⁵ EA

** Requires 68-70 lower mounting brackets

WE PROUDLY FEATURE AUTHENTIC MUSTANG REPRODUCTIONS FROM SCOTT DRAKE!



33

Cooling

IMPORTED, HI-FLOW, 3 CORE RADIATOR



This radiator comes with a full 1 year warranty (limited to repair or replacement only). Brass/copper construction.

Fins designed for maximum cooling. Large 1/2 inch tube diameter increases cooling flow and prevents plugging. Automatic transmission cooler included. Concours correct radiator overflow hose available separately under part number C2AZ-9324-C.

Year	Description	Part No.	List
64-66	6 cylinder	251-3HF	\$259. ⁹⁵ EA
64-66	V8	259-3HF	\$259. ⁹⁵ EA
67-69	200 6 cylinder	329-3HF	\$279. ⁹⁵ EA
67-70	24"	338-3HF	\$349. ⁹⁵ EA
69-70	250, 302	339-3HF	\$279. ⁹⁵
67-69	Small block w/out AC	340-3HF	\$299. ⁹⁵ EA
67-70	390, 428	379-3HF	\$344. ⁹⁵ EA

U.S.A. 4 CORE RADIATORS



Made in the USA with a full 1 year warranty (Limited to repair or replacement), molded foam for optimum shipping

protection, all radiators are 100% pressure tested by manufacturer, meets or exceeds original equipment specifications, long lasting satin black finish, all copper/brass core construction which resists corrosion, state of the art multi-louvered fin design which delivers maximum air flow & cooling. Concours correct radiator overflow hose available separately under part number C2AZ-9324-C. Note: Warranty does not include removal/installation labor or return shipping. Drain valve 8A-8115 sold separately.

Year	Description	Part No.	List
64-66	170, 200 (flat top design)	251-4	\$394. ⁹⁵ EA

RADIATOR SPECIFICATION CHART

NOTE: If your 1967-70 Mustang originally came with a bolt on radiator, and you are purchasing a saddle mount radiator, you will need to buy the proper mounting brackets. * 1967 Cars: Must use 1968 lower saddle mount brackets which are wider.

Radiator	Height / Width	Inlet	Outlet	Mount	
251	2-3-4 Row	16 3/8" x 17 1/4"	1 1/4" diameter top right	1 1/4" diameter bottom left	Bolt on
259	3-4 Row	16 3/8" x 17 1/4"	1 1/2" diameter top right	1 3/4" diameter bottom right	Bolt on
329	2-3 Row	16 3/8" x 20 1/4"	1 1/4" diameter top right	1 1/4" diameter bottom left	Bolt on
338	2-3-4 Row	16" x 24 1/8"	1 1/2" diameter top right	1 3/4" diameter bottom right	Saddle
339	2-3-4 Row	16 3/8" x 20 1/4"	1 1/2" diameter top right	1 3/4" diameter bottom left	Bolt on
340	2-3-4 Row	16 3/8" x 20 1/4"	1 1/2" diameter top right	1 3/4" diameter bottom right	Bolt on
379	3-4 Row	16" x 24 1/8"	1 1/2" diameter top right	1 3/4" diameter bottom left	Saddle
381	3-4 Row	17 3/4" x 26"	1 1/2" diameter top right	1 1/2" - 1 3/4" diameter bottom left	Saddle
556	3-4 Row	17" x 24 1/2"	1 1/2" diameter top right	1 1/2" diameter bottom left	Saddle

Year	Description	Part No.	List
64-66	260, 289 (flat top design)	259-4	\$394. ⁹⁵ EA
67-69	289, 302, and 351 w/ AC	338-4	\$443. ⁹⁵ EA
69-70	250, 302, 351 w/out AC (flat top design)	339-4	\$354. ⁹⁵ EA
67-69	289, 302, 351 w/out AC (flat top design)	340-4	\$354. ⁹⁵ EA
68-70	68-70: 390, 428 70: also 302, 351 w/ AC	379-4	\$376. ⁹⁵ EA
71-73	302, 351, 429	381-4	\$449. ⁹⁵ EA

THERMOSTAT CONTROL

THERMOSTAT



Quality U.S.A. made.

Year	Description	Part No.	List
64-73	190 degree, all engines	RT-1120	\$11. ⁹⁵ EA
64-73	160 degree, 6 cylinder and small block	RT-350	\$11. ⁹⁵ EA
64-73	180 degree, 6 cylinder and small block	RT-351	\$11. ⁹⁵ EA

CONCOURS SMALL BLOCK THERMOSTAT HOUSING



Super quality aluminum casting, which is made in the U.S.A. Exact copy of original, including part numbers. Also available in an aftermarket chrome version.

Year	Description	Part No.	List
64-73	260, 289, 302, 351W w/ out smog, original cast aluminum style	C50E-8592-A	\$20. ⁹⁵ EA
64-73	Small block, chrome	C5Z-8592-C	\$14. ⁹⁵ EA

351C THERMOSTAT HOUSING



Super quality aluminum casting, also available in an aftermarket chrome version.

Year	Description	Part No.	List
70-73	Aluminum Version	DOAZ-8592-A	\$21. ⁹⁵ EA

BIG BLOCK THERMOSTAT HOUSING



This is the correct aluminum water neck (thermostat housing) for big block ford engines. C7AE version is identical

except, we eliminated the thread hole required for Emissions. C7AE is not concours.



Year	Description	Part No.	List
67-70	Big block w/o smog	C7AE-8592-A	\$24. ⁹⁵ EA
68-70	Big block	C8AE-8592-B	\$29. ⁹⁵ EA

THERMOSTAT HOUSING BOLT



Correct headstamp. Sold in pairs.

Year	Description	Part No.	List
64-70	6 cylinder	WNM-CODE-504	\$5. ⁹⁵ PR
64-73	260, 289, 351W	WNM-C20E-506	\$5. ⁹⁵ PR

THERMOSTAT HOUSING GASKET



Thermostat Housing Gasket BY FEL-PRO®

Year	Description	Part No.	List
60-73	6 cylinder and small block	C5AZ-8255-A	\$2. ⁵⁰ EA
67-70	390, 428	C7Z-8255-D	\$2. ⁹⁵ EA
70-73	351 Cleveland	C9Z-8255-A	\$2. ⁹⁵ EA

WATER TEMPERATURE SENDING UNIT

Brass sensor that screws into intake manifold and activates temperature gauge in dash.



64-66
All engines before 9/1/65
C3AZ-10884-A

List
\$6.⁹⁵ EA



66-69
200, 289, 302 and 390 after 9/1/65
C6DZ-10884-B

List
\$6.⁹⁵ EA



Brass water temperature gauge sending unit. NOTE: For vehicles with in-dash temperature gauge only. Will not work on vehicles

with water temperature warning light.

Year	Description	Part No.	List
70-73	302, 351	DOZ-10884-A	\$11. ⁹⁵ EA

DECALS

CHASIS BODY & EXTERIOR

3" MUSTANG DECAL



A brightly colored three inch round decal featuring the famous running horse.



Year	Part No.	List
64-73	DF-266	\$4.95 EA

FORD BLUE OVAL DECAL



The contemporary Ford blue oval on a decal.



Year	Description	Part No.	List
64-73	3 1/2" oval	DF-361	\$3.95 EA
64-73	6 1/2" oval	DF-362	\$4.95 EA
64-73	9 1/2" oval	DF-363	\$5.50 EA
64-73	17" oval	DF-364	\$7.95 EA

FORD DRAG TEAM DECAL



Bold block letters proclaiming this car as a member of the Ford Factory Drag Team.



Year	Description	Part No.	List
64-73	5" Rectangle	DZ-115	\$4.95 EA
64-73	8" Rectangle	DZ-116	\$7.95 EA

GENUINE PARTS OVAL DECAL



Copy of vintage logo.



Year	Description	Part No.	List
64-73	3" blue oval	DF-531	\$3.75 EA

FENDER DECAL



Identical to the factory markings.



Year	Description	Part No.	List
69-70	Boss 429 black	DF-225	\$14.95 EA
69-70	Boss 429 white	DF-226	\$14.95 EA

BOSS 351 MUSTANG



Year	Description	Part No.	List
71	Boss 351, black	DF-505	\$14.95 EA
71	Boss 351, argent	DF-506	\$14.95 EA

Mach 1



Year	Description	Part No.	List
71-72	Mach 1, black	DF-675	\$14.95 EA
71-72	Mach 1, argent	DF-676	\$14.95 EA

KONI DECAL



The timeless Koni wings on a sticker.

Year	Part No.	List
64-73	DZ-112	\$5.95 EA

OUTSIDE TRUNK DECAL

BOSS 351

Year	Description	Part No.	List
71	Boss 351, black	DF-507	\$10.95 SE
71	Boss 351, argent	DF-508	\$10.95 SE

Mach 1

Year	Description	Part No.	List
71-72	Mach 1, black	DF-677	\$10.95 SE
71-72	Mach 1, argent	DF-678	\$10.95 SE

RAM AIR HOOD DECAL

351 RAM AIR

"RAM AIR" letters.



Year	Description	Part No.	List
70	351, black	DF-383	\$7.50 EA
70	428, black	DF-516	\$7.50 EA
71	429 RAM AIR, black	DF-420	\$7.50 EA
71	429 RAM AIR, argent	DF-419	\$7.50 EA
71-72	RAM AIR, black	DF-385	\$7.50 EA
71-72	RAM AIR, argent	DF-384	\$7.50 EA
71-72	351 RAM AIR, black	DF-387	\$7.50 EA
71-72	351 RAM AIR, argent	DF-386	\$7.50 EA

RUNNING HORSE DECAL



Running Bar Horse Decal. Red, white, and blue bars with a silver horse.



Year	Description	Part No.	List
64-73	5", LH	DZ-253	\$7.95 EA
64-73	5", RH	DZ-254	\$7.95 EA
64-73	7", LH	DZ-255	\$8.95 EA
64-73	7", RH	DZ-256	\$8.95 EA

SHELBY DECAL



64-73
3" square w/ CS logo
DF-501



List

\$3.95 EA



65-70
2 1/4" round w/ Tiffany snake, for shock absorber
DF-635



List

\$3.95 EA



65-70
10" round, for Shelby hi-performance equipment
DZ-110



List

\$6.95 EA



65-70
1 5/8" x 7 1/4" w/ CS Shelby logo
DZ-70



List

\$4.95 EA

PAINT OK DECAL

These were used to confirm that the vehicles paint and trim had passed inspection.



64-73
Red "P"
DF-1157

List

\$4.95 EA



69-71
DF-460

List

\$4.95 EA

SHOCKS DECAL



Replicas of the decals that identified the shocks on the factory drag race Mustangs of 1969/70.

Year	Description	Part No.	List
69-70	Hurst shock decal set	DZ-75	\$4.95 EA

WHEEL CENTER DECAL



65-67
Wire wheel, blue
DF-533



List

\$4.95 EA

WE PROUDLY FEATURE AUTHENTIC MUSTANG REPRODUCTIONS FROM SCOTT DRAKE!



WHEEL CENTER DECAL (CONTINUED)



66
Shelby Hertz car club
DF-587

List

\$4.95 EA



66
Shelby 5 spoke wheel center
DF-588

List

\$4.95 EA

USA BODY SHIELD DECAL



This decal went on the rear of the quarter panel of the 1972 Olympic Sprint convertible of which only fifty were produced.

Year	Part No.	List
72	DF-388	\$7.95 EA

DECAL KITS

DECAL KIT

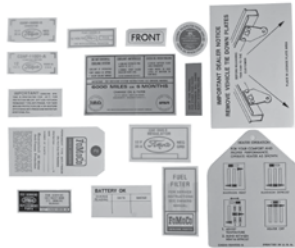

Great Detailing Aid. These Kits include all the common decals. Air Cleaner & AC decal are not included.

Year	Part No.	List
64	DK-24	\$20.95 KI
65	DK-25	\$20.95 KI
66	DK-26	\$20.95 KI
67	DK-27	\$20.95 KI
68	DK-28	\$20.95 KI
69	DK-29	\$20.95 KI
70	DK-30	\$20.95 KI
71	DK-31	\$20.95 KI
72	DK-32	\$20.95 KI
73	DK-33	\$20.95 KI

EMISSION DECALS

EMISSIONS DECAL



This decal shows that this vehicle complied with emission regulations.



Year	Description	Part No.	List
69-70	GT 500	DF-174	\$4.95 EA
69-70	Boss 302	DF-197	\$4.95 EA
68-69	Big block, 4V	DF-297	\$4.95 EA
70	Boss 302, late 1970	DF-344	\$4.95 EA
71	Boss 351, manual trans	DF-455	\$4.95 EA
72	351 Cleveland, 4V	DF-534	\$4.95 EA
71	351, 2V	DF-554	\$4.95 EA
71	429 Cobra Jet, 4V	DF-555	\$4.95 EA
68-69	302, 351, 4V	DF-562	\$4.95 EA
73	351, 4V, manual trans	DF-582	\$4.95 EA
72	351 Cleveland, 2V	DF-594	\$4.95 EA
73	351 Cleveland, 2V, automatic trans	DF-640	\$4.95 EA
73	302, 2V	DF-641	\$4.95 EA
70	Boss 302, manual trans	DF-650	\$4.95 EA
70	351, 4V	DF-742	\$4.95 EA
71	302, 2V	DF-763	\$4.95 EA
69	GT 390, 4V	DF-782	\$4.95 EA

ENGINE COMPARTMENT

AIR CLEANER DECAL



Identical to the factory decal that designated engine and carburetor size as well as service instructions.



Year	Description	Part No.	List
64	260 CID	DF-45	\$3.50 EA
64-65	Service	DF-83	\$3.95 EA
64-66	Vent	DF-350	\$3.95 EA
64-67	289 High Performance	DF-15	\$3.95 EA
64-68	Air cleaner, V8	DF-160	\$3.95 EA
64-68	Air cleaner, 6 cyl.	DF-352	\$3.95 EA
64-73	Front	DF-150	\$3.00 EA
65	170 CID	DF-95	\$3.95 EA
65-66	289-2V	DF-13	\$3.95 EA
65-66	289-4V	DF-14	\$3.95 EA
65-68	200 CID	DF-59	\$3.95 EA
65-70	Ventra Flow	DF-477	\$5.95 EA
66	200 CID Sprint	DF-171	\$3.95 EA
66	Part Number	DF-37	\$3.00 EA
66-73	Service	DF-149	\$3.00 EA
67	Cobra	DF-744	\$3.95 EA
67	Part Number	DF-261	\$3.00 EA
67-68	289-2V	DF-104	\$3.95 EA
67-68	289-4V	DF-105	\$3.95 EA
67-68	390 High Performance	DF-322	\$4.95 EA
67-68	Sports Sprint	DF-246	\$3.95 EA
67-69	390 CID	DF-53	\$3.95 EA
67-69	390 4V, premium fuel	DF-54	\$3.95 EA
68	428-4V, premium fuel	DF-221	\$3.95 EA
68	427-4V, premium fuel	DF-316	\$3.95 EA
68	427 4V High Performance	DF-324	\$3.95 EA
68-69	302 High Performance	DF-321	\$3.95 EA
68-69	250 CID	DF-443	\$3.95 EA
68-69	302-2V	DF-60	\$3.95 EA
68-69	302-4V, premium fuel	DF-61	\$3.95 EA
69	351-2V	DF-62	\$3.95 EA
69	351-4V, premium fuel	DF-63	\$3.95 EA
69	428	DF-778	\$3.95 EA
69	Boss 302	DF-162	\$3.95 EA
69-70	Cobra Jet Ram Air	DF-178	\$3.95 EA
69-70	351 Ram Air	DF-179	\$3.95 EA
70	250 CID	DF-172	\$3.95 EA
70-71	302 2V, regular fuel	DF-182	\$3.95 EA
70-71	302-4V, premium fuel	DF-183	\$3.95 EA
70-71	351-2V, regular fuel	DF-184	\$3.95 EA
70-71	351-4V, premium fuel	DF-185	\$3.95 EA
70-71	390-4V, premium fuel	DF-479	\$3.95 EA
71	Boss 351	DF-260	\$6.95 SE
71	429 Cobra Jet	DF-395	\$3.95 EA
71	429-4V, premium fuel	DF-451	\$3.95 EA
71-73	351-2V, regular fuel	DF-668	\$3.95 EA
72	351 Cobra Jet	DF-365	\$3.95 EA
72	351 HO	DF-553	\$3.95 EA
72-73	250 1V	DF-643	\$3.95 EA
72-73	302-2V, regular fuel	DF-584	\$3.95 EA
72-73	302-4V, premium fuel	DF-254	\$3.95 EA
72-73	351-2V, regular fuel	DF-255	\$3.95 EA

Year	Description	Part No.	List
72-73	351-4V, regular fuel	DF-256	\$3.95 ^{EA}

AIR CONDITIONING DECAL



Year	Description	Part No.	List
64-66	AC sight glass	DF-1130	\$3.95 ^{EA}
67-68	AC Dryer	DF-153	\$3.95 ^{EA}
64-70	AC aluminum tag	DF-351	\$5.95 ^{EA}
71-73	AC charge mounts on radiator support	DF-532	\$4.50 ^{EA}
67-70	AC clutch	DF-548	\$3.50 ^{EA}
70	AC Dryer	DF-549	\$3.50 ^{EA}
64-66	AC Dryer	DF-550	\$3.50 ^{EA}
69	AC Dryer	DF-656	\$3.50 ^{EA}

AUTOLITE DECAL



Select from a variety of vintage Autolite decals. requirements.



Year	Description	Part No.	List
67-70	Fuel filter	DF-656	\$3.50 ^{EA}
64-68	Air cleaner, V8	DF-160	\$3.95 ^{EA}
68-75	Air Cleaner	DF-325	\$4.95 ^{EA}
64-68	Air cleaner, 6 cyl.	DF-352	\$3.95 ^{EA}
64-70	FL-1 oil filter	DF-684	\$4.95 ^{EA}
64-70	F-11 racing oil filter	DF-783	\$4.95 ^{EA}
64-72	Sta-ful battery tag	DF-784	\$4.95 ^{EA}
64-73	Autolite/Ford, 1/2" X 2 1/2" Rectangle	DZ-120	\$4.95 ^{EA}
64-73	5" GT-40 rectangle	DZ-122	\$4.95 ^{EA}
64-73	8" GT-40 rectangle	DZ-123	\$4.95 ^{EA}
64-73	Autolite spark plugs, 6.5" round	DZ-4	\$4.95 ^{EA}
64-73	Autolite spark plugs, 4" round	DZ-5	\$4.95 ^{EA}

BATTERY DECAL

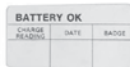

This decal informed the buyer that the battery was checked and was certified to be OK.

Year	Part No.	List
64-70	DF-194	\$3.50 ^{EA}
64	DF-405	\$3.50 ^{EA}

CAUTION FAN DECAL



Decal placed on the fan shroud to remind you to keep all ten of your fingers.

Part No.	Year	List
DF-31	68-69	\$3.50 ^{EA}

COIL DECAL



Makes coil look more authentic.

Year	Part No.	List
65-72	DF-224	\$4.95 ^{EA}
64	DF-33	\$- ^{EA}
72-73	DF-715	\$4.95 ^{EA}

COOLANT WARNING DECAL



Decal supplied to inform owner of cooling system requirements.



Year	Part No.	List
64-66	DF-250	\$4.95 ^{EA}

DISC BRAKE MASTER CYLINDER DECAL



Advised owner of the proper brake fluid for each vehicle.

Year	Part No.	List
66	DF-331	\$3.50 ^{EA}
67	DF-332	\$4.95 ^{EA}

FORD 6000 MILE OR 6 MONTH LUBE DECAL



Year	Part No.	List
64-73	DF-746	\$3.95 ^{EA}

FUEL FILTER DECAL



A decal supplied with the fuel filter on all cars.



Year	Part No.	List
64-66	DF-280	\$- ^{EA}

GENERATOR DECAL



This decal was on the generator to insure proper fitment.



Year	Part No.	List
64	DF-515	\$4.95 ^{EA}

MOTORCRAFT DECAL



Motorcraft GT 40 sticker with the famous Speeding racer.



Year	Description	Part No.	List
64-73	6 1/4" x 5"	DZ-121	\$5.50 ^{EA}

OIL FILLER CAP DECAL



This decal was put on the oil cap to alert the owner about the recommended type of oil to use.



Year	Part No.	List
64-66	DF-164	\$3.00 ^{EA}

OIL FILTER DECAL



Decals to go on a regular oil filter to give the appearance of a vintage Ford filter.

Year	Description	Part No.	List
64-67	Rotunda, red	DF-613	\$5.50 ^{EA}
64-67	6000 Mile Rotunda, gold	DF-647	\$5.50 ^{EA}

SERVICE SPECIFICATION DECAL



This sticker was used to alert the owner of regular service schedules.



Year	Part No.	List
64	DF-345	\$4.00 ^{EA}
65-66	DF-20	\$4.00 ^{EA}
67-69	DF-52	\$4.00 ^{EA}
70	DF-346	\$4.00 ^{EA}
71	DF-308	\$4.00 ^{EA}

Decals

WE PROUDLY FEATURE AUTHENTIC MUSTANG REPRODUCTIONS FROM SCOTT DRAKE!



STARTER DECAL



This decal was put on the starter to assure proper fitment.



Year	Part No.	List
64	DF-447	\$4.50 EA

VALVE COVER DECAL



Year	Description	Part No.	List
69-70	Boss 302	DF-138	\$3.95 PR
65-67	289 Cobra	DF-373	\$4.95 EA
71	Boss 351	DF-394	\$3.95 PR
64-73	Powered By Ford, chrome	DF-410	\$3.95 EA
64-73	Powered By Ford, white	DF-411	\$3.95 EA

VOLTAGE REGULATOR DECAL



This was put on each voltage regulator to inform that it was the correct part.

Year	Description	Part No.	List
65-70	Warning, red	DF-320	\$4.95 EA
64-66	Warning, yellow	DF-347	\$4.95 EA
67	Autolite	DF-348	\$4.95 EA
65-66	Autolite	DF-412	\$4.95 EA
68-71	Autolite, high Performance	DF-464	\$4.95 EA
72-73	Motorcraft	DF-714	\$4.95 EA

ANTIFREEZE TAG



A tag attached to the radiator that explains service procedures.



Year	Description	Part No.	List
64-70	FoMoCo	DF-120	\$4.95 EA
64-66	Rotunda	DF-699	\$4.95 EA
67-73	Ford	DF-700	\$4.95 EA

INTERIOR DECALS

RADIO REVERBERATION DECAL



A decal for the radio telling of reverb opt



Year	Description	Part No.	List
69-70	GT 350	DF-196 ⁶	\$4.95 EA
69-70	GT 500	DF-298 ⁸	\$4.95 EA

SHELBY FOG LIGHT & INTERIOR CONSOLE DECAL



Decal for fog light and interior light switch.

Year	Part No.	List
69-70	DF-173	\$3.00 EA

STEREO DOOR SPEAKER DECAL



Stereo script to go on speakers.

Year	Part No.	List
69-70	DF-577	\$3.95 EA

SUN VISOR SEAT BELT DECAL

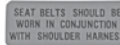

Shelby Sun Visor Seat Belt Decal and the small silver snake decal supplied on the buckle of Shelby seat belts.

Year	Part No.	List
67-70	DF-343	\$3.95 EA

SHELBY SEAT BELT INSERT EMBLEM

They are the most authentic and best looking emblems available.



67:
Shelby Cobra
S7MS-63611A73-A



List
\$7.95 PR



68
Shelby Cobra, gold
S8MS-63611A73-A



List
\$7.95 PR



69-70
Shelby
S8MS-63611A73-A



List
\$7.95 PR

SUN VISOR STARTING INSTRUCTION SLEEVE



Instructions showing how to start your Mustang.



Year	Part No.	List
64-70	DF-170	\$4.95 EA

TIRE PRESSURE DECAL



A Ford licensed product, this decal gives loads of information about your cars original tires.



Year	Description	Part No.	List
65-66	For cars w/"Red Ring" sidewalls	DF-463	\$3.95 EA
66		DF-19	\$3.95 EA
67-68	Shelby, high speed	DF-158	\$3.95 EA
67-68		DF-282	\$3.95 EA
67-68	Shelby	DF-586 ⁶	\$3.95 EA
68	Door	DF-283	\$3.95 EA
69	Early 1969	DF-559	\$3.95 EA
69	Late 1969	DF-376	\$3.95 EA
69-70	Shelby, glove box	DF-137 ⁶	\$3.95 EA
69-70	Glove box	DF-310	\$3.95 EA
70	Door	DF-1004	\$3.95 EA
71		DF-377	\$3.95 EA

CAUTION DRIVEN INSTRUCTION TAG



This decal was supplied to instruct the owner that the car should be driven regularly to keep components working properly.

Year	Part No.	List
64-69	DF-208	\$4.95 EA

DISC BRAKE WARNING TAG



A warning tag that shows proper use and care of disc brakes.

Part No.	Year	List
DF-729	65	\$4.95 EA

HEATER INSTRUCTION TAG



A paper tag that was hanging from the heater knob when you bought the car.

Year	Part No.	List
64	DF-51	\$4.95 ^{EA}
65-66	DF-564	\$4.95 ^{EA}

NOVELTY WARNING TAG



A fun tag for your Shelby GT that warns of the consequences of driving near pretty girls.

Year	Description	Part No.	List
65-70	Shelby GT 350	DF-625	\$- ^{EA}
67-70	Shelby GT 500	DF-626	\$3.95 ^{EA}

SEAT BELT RETRACTOR TAG



A tag supplied with cars to explain the proper way to use the retractable seat belts.

Year	Part No.	List
64-67	DF-305	\$4.95 ^{EA}

WINDSHIELD WASHER ADJUSTER TAG



Year	Part No.	List
65-66	DF-444	\$3.95 ^{EA}

NEW CAR WINDOW PRICE STICKER



Year	Description	Part No.	List
66	Shelby	DF-123 ^S	\$4.95 ^{EA}
68	Shelby	DF-200	\$4.95 ^{EA}
67	GT 500	DF-227	\$4.95 ^{EA}
67	GT 350	DF-228 ^S	\$4.95 ^{EA}
66		DF-25	\$4.95 ^{EA}
65		DF-43	\$4.95 ^{EA}
64		DF-595	\$4.95 ^{EA}
71		DF-87	\$4.95 ^{EA}
69		DF-88	\$4.95 ^{EA}

PRE-DELIVERY DECALS

SHELBY PRE-DELIVERY SHEET



This sheet was given to the buyer at the dealership to show that his new Shelby had gone through a series of checks and tests.



Year	Description	Part No.	List
68		DF-476 ^S	\$3.95 ^{EA}
66	GT 350	DF-660 ^S	\$3.95 ^{EA}
69		DF-663 ^S	\$3.95 ^{EA}

STRIPES

GT STENCIL KIT



Stencil kit or patterns to install GT stripe kit, Mustang letters and Mustang emblems.

Year	Part No.	List
65-66	MSK001	\$14.95 ^{PR}

BOSS 302 STRIPE KIT



Excellent quality automotive grade vinyls. All of our stripe kits have special agents added for U.V. protection. Mill

thicknesses are equal to the original O.E. stripes.



Year	Description	Part No.	List
69	Black	C9ZZ-6320000-V	\$194.95 ^{KI}
69	White	C9ZZ-6320000-W	\$194.95 ^{KI}



Year	Description	Part No.	List
70	Black	DOZZ-6320000-C	\$229.95 ^{KI}

C STRIPE KIT



Our quality reproduction stripe kits come with installation instructions, squeegee. Excellent quality automotive grade

vinyls. All of our stripe kits have special agents added for U.V. protection. Mill thicknesses are equal to the original O.E. stripes Individually boxed.



Year	Description	Part No.	List
68	Black	C8ZZ-6520000-A	\$59.95 ^{KI}
68	White	C8ZZ-6520000-B	\$59.95 ^{KI}
68	Red	C8ZZ-6520000-C	\$59.95 ^{KI}
68	Blue	C8ZZ-6520000-D	\$59.95 ^{KI}
68	Gold	C8ZZ-6520000-E	\$59.95 ^{KI}
68	Reflective Gold	C8ZZ-6520000-R	\$99.95 ^{KI}

MACH 1/BOSS 351/RALLY STRIPE KIT



Excellent quality automotive grade vinyls. All of our stripe kits have special agents added for U.V. protection. Mill

thicknesses are equal to the original O.E. stripes. Mach 1 kits include trunk stripe.



Year	Description	Part No.	List
69	Mach 1, Black/Gold	C9ZZ-6320000-A	\$169.95 ^{KI}
69	Mach 1, Red/Gold	C9ZZ-6320000-C	\$169.95 ^{KI}
69	Mach 1, Gold/White	C9ZZ-6320000-G	\$169.95 ^{KI}



Year	Description	Part No.	List
71-72	Boss, Rally, Black, side stripe only	D1ZZ-6320000-A	\$134.95 ^{KI}
71-72	Boss, Rally, Argent, side stripe only	D1ZZ-6320000-R	\$134.95 ^{KI}



Year	Description	Part No.	List
73	Mach 1, Argent	D3ZZ-6320000-A	\$119.95 ^{KI}
73	Mach 1, Black	D3ZZ-6320000-BK	\$119.95 ^{KI}

WE PROUDLY FEATURE AUTHENTIC MUSTANG REPRODUCTIONS FROM SCOTT DRAKE!



GT STRIPE KIT



Our quality reproduction stripe kits come with installation instructions, squeegee. Excellent quality automotive grade

vinyls. All of our stripe kits have special agents added for U.V. protection. Mill thicknesses are equal to the original O.E. stripes Individually boxed.



Year	Description	Part No.	List
65-66	Black	CSZZ-6520000-A	\$29 ⁹⁵ KI
65-66	White	CSZZ-6520000-B	\$29 ⁹⁵ KI
65-66	Red	CSZZ-6520000-C	\$29 ⁹⁵ KI
65-66	Blue	CSZZ-6520000-D	\$29 ⁹⁵ KI
67	Black	C7ZZ-6520000-A	\$29 ⁹⁵ KI
67	White	C7ZZ-6520000-B	\$29 ⁹⁵ KI
67	Red	C7ZZ-6520000-C	\$29 ⁹⁵ KI
67	Blue	C7ZZ-6520000-D	\$29 ⁹⁵ KI
69	Black	C9ZZ-6520000-A	\$79 ⁹⁵ KI
69	White	C9ZZ-6520000-B	\$79 ⁹⁵ KI
69	Blue	C9ZZ-6520000-D	\$84 ⁹⁵ KI
69	Gold	C9ZZ-6520000-E	\$84 ⁹⁵ KI

SHELBY STRIPE KIT



Our quality reproduction stripe kits come with installation instructions. Individually boxed. Note:

1967 Shelby's had an Early & Late version. The Fender stripe was different S7MS-16224-B late version is pictured. 1969-70 Kits will fit Fastback and Convertible.



Year	Description	Part No.	List
65	Blue	S1MS-16224-B	\$64 ⁹⁵ KI
66-68	Black GT350	S2MS-16224-A	\$59 ⁹⁵ KI
66-68	White GT350	S2MS-16224-B	\$59 ⁹⁵ KI
66-68	Red GT350	S2MS-16224-C	\$59 ⁹⁵ KI
66-68	Blue GT350	S2MS-16224-D	\$59 ⁹⁵ KI
66	Hertz gold	S2MS-16224-G	\$79 ⁹⁵ KI
67E	White GT350	S7MS-16224-F	\$59 ⁹⁵ PR
67E	Black GT350	S7MS-16224-G	\$59 ⁹⁵ PR
67E	BlueGT350	S7MS-16224-H	\$59 ⁹⁵ PR
67L-68	Black GT500	S7MS-16224-A	\$59 ⁹⁵ PR
67L-68	White GT500	S7MS-16224-B	\$59 ⁹⁵ PR
67L-68	Blue GT500	S7MS-16224-D	\$59 ⁹⁵ PR
67E	Black GT500	S7MS-16224-AE	\$59 ⁹⁵ PR
67E	White GT500	S7MS-16224-BE	\$59 ⁹⁵ PR
67E	BlueGT500	S7MS-16224-DE	\$59 ⁹⁵ PR
68	Black, GT500 KR	S8MS-16224-B	\$69 ⁹⁵ KI
68	White, GT500 KR	S8MS-16224-W	\$69 ⁹⁵ KI
69-70	Black GT350	S9MS-16224-A	\$229 ⁹⁵ KI
69-70	White GT350	S9MS-16224-B	\$229 ⁹⁵ KI
69-70	Blue GT350	S9MS-16224-D	\$229 ⁹⁵ KI

Year	Description	Part No.	List
69-70	Gold GT350	S9MS-16224-G	\$229 ⁹⁵ KI
69-70	Black, GT500	S9MS-16224-F	\$229 ⁹⁵ KI
69-70	White GT500	S9MS-16224-C	\$229 ⁹⁵ KI
69-70	Blue, GT500	S9MS-16224-H	\$229 ⁹⁵ KI
69-70	Gold GT500	S9MS-16224-E	\$229 ⁹⁵ KI

CALIFORNIA SPECIAL STRIPE KIT



Our quality reproduction stripe kits come with installation instructions, squeegee. Individually boxed.



Year	Description	Part No.	List
68	Black	C8ZX-16224-A	\$114 ⁹⁵ KI
68	White	C8ZX-16224-B	\$114 ⁹⁵ KI
68	Red	C8ZX-16224-C	\$114 ⁹⁵ KI

TRUNK LID STRIPE KIT



Excellent quality automotive grade vinyls. All of our stripe kits have special agents added for U.V. protection. Mill

thicknesses are equal to the original O.E. stripes



Year	Description	Part No.	List
70	Mach 1, Black	SK-009	\$36 ⁹⁵ KI

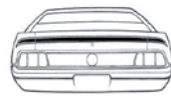

Year	Description	Part No.	List
71-72	Mach 1, Black	SK-010	\$39 ⁹⁵ KI
71-72	Mach 1, Argent	SK-011	\$39 ⁹⁵ KI



Year	Description	Part No.	List
71	Boss 351, Black	SK-012	\$24 ⁹⁵ KI
71	Boss 351, Argent	SK-013	\$24 ⁹⁵ KI



Year	Description	Part No.	List
73	Mach 1, Argent	SK-023	\$39 ⁹⁵ KI
73	Mach 1, Black	SK-024	\$39 ⁹⁵ KI

DEARBORN HOOD STRIPE STENCIL

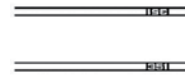

A stencil kit to help you get those stripes straight when repainting the hood.

Year	Description	Part No.	List
70	351 For hood	GE-811-351	\$56 ⁹⁵ EA
70	428 For hood	GE-811-428	\$54 ⁹⁵ EA

SHAKER HOOD STRIPE STENCIL



A stencil kit to help you get those stripes straight when repainting the hood.

Part No.	Year	Description	List
GE-812-351	70	351 For hood	\$69 ⁹⁵ EA
GE-812-428	70	428 For hood	\$69 ⁹⁵ EA

TRUNK COMPARTMENT

JACK INSTRUCTION DECAL



Instructions for the use and storage of the stock jack.

Year	Description	Part No.	List
65		DF-145	\$3 ⁹⁵ EA
66		DF-146	\$3 ⁹⁵ EA
67	Early 1967	DF-371	\$3 ⁹⁵ EA
67-68	Late 1967, and 1968	DF-44	\$3 ⁹⁵ EA
68	Styled steel wheel	DF-374	\$3 ⁹⁵ EA
68-70	Space saver	DF-368	\$3 ⁹⁵ EA
69-70	Styled wheel	DF-77	\$3 ⁹⁵ EA
69-70	Regular wheel	DF-78	\$3 ⁹⁵ EA
71	Regular wheel, early 1971	DF-46	\$3 ⁹⁵ EA
71	Space saver spare, late 1971	DF-218	\$3 ⁹⁵ EA
71	Space saver	DF-367	\$3 ⁹⁵ EA
71-72	Regular wheel, 1971/72	DF-413	\$3 ⁹⁵ EA
71-72	Space saver	DF-414	\$3 ⁹⁵ EA
73	Convertible	DF-465	\$3 ⁹⁵ EA
73	Coupe	DF-653	\$3 ⁹⁵ EA

SHELBY SAFETY ACT DECAL



This decal was supplied to assure that the car complied with federal safety regulations.



Year	Part No.	List
68-69	DF-169 ⁹	\$3. ⁹⁵ EA

FORD SAFETY ACT DECAL

This decal assured that your new car complied with federal safety laws when it was delivered to the customer.



68-69
DF-168

List

\$4.⁹⁵ EA



66-68
DF-665

List

\$4.⁹⁵ EA

SPACE SAVER INFLATION BOTTLE DECAL

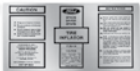

Original inflation instructions for the space saver "inflator" bottle.



Year	Part No.	List
68	DF-811	\$4. ⁹⁵ EA
69	DF-812	\$4. ⁹⁵ EA
70	DF-813	\$4. ⁹⁵ EA
71-73	DF-814	\$4. ⁹⁵ EA

SPACE SAVER SPARE INSTRUCTION DECAL



Safety instructions for the proper use and storage of the space saver spare tire.



Year	Part No.	List
68-70	DF-244	\$3. ⁰⁰ EA

SPACE SAVER TRUNK LID DECAL



This decal explains the use and storage of the space saver spare tire and wheel.



Year	Part No.	List
68-70	DF-281	\$4. ⁹⁵ EA

B.F. GOODRICH SPACE SAVER POSTCARD



A post card that was sent to owners of cars equipped with space saver tires to warn of possible problems.

Year	Part No.	List
68-71	DF-807	\$3. ⁰⁰ EA

WINDOW DECALS

COBRA WINDOW DECAL

These self-adhesive decals look great on your front or back windshield or just about anywhere around the home or shop. 3 different cobra styles to choose from.



64-73
Cobra Jet
w/ burning wheels
DF-393



List

\$4.⁹⁵ EA



64-73
Cobra
w/ burning wheels
DF-822



List

\$4.⁹⁵ EA

MUSCLE POWER WINDOW DECAL



A brightly colored sticker that is reminiscent of the 70's flower power theme.

Year	Description	Part No.	List
64-73	For outside window	DZ-114	\$7. ⁹⁵ EA

PRODUCTION DAY WINDOW DECAL



This decal was used to tell what day the car was produced.

Year	Description	Part No.	List
64-75	Day 7	DF-1012	\$3. ⁹⁵ EA

DOOR PARTS

INSIDE DOOR HANDLES, WINDOW CRANKS & REGULATORS

INSIDE DOOR HANDLE AND WINDOW CRANK KIT



Kit includes clip or screw-on door handles, window cranks, quarter window cranks (for coupe and convertible), clips/screws and backing plates. Available in show-quality chrome or satin (satin pictured).

Year	Description	Part No.	List
65	Early 65 Fastback, chrome	KIT-DH-1	\$49. ⁹⁵ KI
64-65	Early 65 coupe or convertible, chrome	KIT-DH-2	\$62. ⁹⁵ KI
65-67	Late 65 Fastback, chrome	KIT-DH-3	\$49. ⁹⁵ KI
65-67	Late 65 Fastback, satin	KIT-DH-3S	\$58. ⁹⁵ KI
65-67	Late 65 coupe or convertible, chrome	KIT-DH-4	\$65. ⁹⁵ KI
65-67	Late 65 coupe or convertible, satin	KIT-DH-4S	\$75. ⁹⁵ KI
68	Fastback, chrome	KIT-DH-7	\$68. ⁹⁵ KI
68	Coupe or convertible, chrome	KIT-DH-8	\$90. ⁹⁵ KI
68	Fastback, chrome w/ black knobs	KIT-DH-7-BK	\$75. ⁹⁵ KI
68	Coupe or convertible, chrome w/black knobs	KIT-DH-8-BK	\$99. ⁹⁵ KI

WE PROUDLY FEATURE AUTHENTIC MUSTANG REPRODUCTIONS FROM SCOTT DRAKE!



INSIDE DOOR HANDLES

Excellent reproductions of the originals, fit is perfect. All of these handles feature a brightly polished, chrome finish or our custom satin chrome finish.



64- Early 65
RH or LH, Chrome
C7AZ-6222600-B

List

\$11.95 EA



Late 65-67
RH or LH, Chrome
Will not fit 67 Deluxe
C5Z-6522600-C

List

\$11.95 EA



Late 65-67
RH or LH, Satin
C5Z-6522600-S

List

\$13.95 EA



65-66
Deluxe, Chrome Woodgrain
C5Z-6522600-A (RH)
C5Z-6522601-A (LH)

List

\$22.00 EA



Excellent reproductions of the originals, fit is perfect. All of these handles feature a brightly polished, chrome finish and genuine leather insert.

Year	Description	Part No.	List
65-66	Deluxe leather with chrome finish, pair	C7ZZ-6522600-A	\$44.95 PR



This is a Scott Drake exclusive. Made to fit the 1967 Deluxe door panel. Yes, they were different. Made with the same attention to detail and quality of our other interior door handles. You must use this handle when installing deluxe door panels.

Year	Description	Part No.	List
67	Deluxe RH & LH	C7ZZ-6522600-A	\$22.95 EA



Excellent reproductions of the originals, fit is perfect. All of these handles feature a brightly polished, chrome finish or our custom satin chrome finish.

Year	Description	Part No.	List
68 RH	Chrome	C7AZ-5422600-B	\$22.95 EA
68 LH	Chrome	C7AZ-5422601-B	\$22.95 EA
68 RH	Satin	C7AZ-5422600-S	\$26.95 EA
68 LH	Satin	C7AZ-5422601-S	\$26.95 EA



Excellent reproductions featuring a brightly polished, chrome finish.

Year	Description	Part No.	List
69-70	RH	C9AZ-6222600-A	\$22.95 EA
69-70	LH	C9AZ-6222601-A	\$22.95 EA



Excellent reproductions featuring a brightly polished, chrome finish. Fits Mach1 and Deluxe interiors..

Year	Description	Part No.	List
71-73	Deluxe RH	D1ZZ-6522600-A	\$22.95 EA
71-73	Deluxe LH	D1ZZ-6522601-A	\$22.95 EA

DOOR SHAFT ASSEMBLY



Gold cadmium plated and made from our own tooling. Our 64-66 standard interior shafts will accommodate early clip-on handles.

Year	Description	Part No.	List
64-66	Standard, RH	C5Z-6521818-C	\$14.95 EA
64-66	Standard, LH	C5Z-6521819-C	\$14.95 EA
65-66	Pony, RH	C5Z-6521818-B	\$14.95 EA
65-66	Pony, LH	C5Z-6521819-B	\$14.95 EA
67-68	RH	C60Z-6221818-B	\$14.95 EA
67-68	LH	C60Z-6221819-B	\$14.95 EA

UNIVERSAL DOOR WINDOW REGULATOR



Good quality universal style fits both screw on and clip on style window cranks. Same high quality as our concours regulators but with a specially designed shaft that will fit both styles of cranks. 1 year warranty.

Year	Description	Part No.	List
64-66	Universal, RH	C5Z-6523202-E	\$29.95 EA
64-66	Universal, LH	C5Z-6523203-E	\$29.95 EA

64-66 CONCOURS DOOR WINDOW REGULATORS



Excellent replacement, silver cadmium plated to prevent rust. Engineered for a perfect fit. Will not self destruct like others.

These are the finest available. They feature original metal thickness on body, large gear and swing arm, high tension spring to ease in operation, correct threads, splined shaft, exact dimensions as original for proper handle alignment, extra strong internal gear with improved rivets. Attractively boxed and a 2 year warranty. 1964 version is clip-on style, 65-66 version is screw-on style.

Year	Description	Part No.	List
64	Concours, RH	C5Z-6523202-A	\$34.95 EA
64	Concours, LH	C5Z-6523203-A	\$34.95 EA
65-66	Concours, RH	C5Z-6523202-B	\$34.95 EA
65-66	Concours, LH	C5Z-6523203-B	\$34.95 EA

67-68 CONCOURS DOOR WINDOW REGULATORS



Made by Scott Drake, 67-68 Concours Window Regulators. These window regulators are painted black, like the originals. Available for either the RH or LH side.

Year	Description	Part No.	List
67	Concours, RH	C7ZZ-6523200-AR	\$64.95 EA
67	Concours, LH	C7ZZ-6523201-AR	\$64.95 EA
68	Concours, RH	C8ZZ-6523200-AR	\$64.95 EA
68	Concours, LH	C8ZZ-6523201-AR	\$64.95 EA

69-73 DOOR WINDOW REGULATOR



Quality reproductions.

Year	Description	Part No.	List
69	RH	C9ZZ-6523200-AR	\$69.95 EA
69	LH	C9ZZ-6523201-AR	\$69.95 EA
70	RH	D0ZZ-6523201-AR	\$69.95 EA
70	RH	D0ZZ-6523200-AR	\$69.95 EA

WINDOW REGULATOR RETAINER CLIP



Secures window regulator to scissor mechanism.

Year	Description	Part No.	List
64-66		353745-S	\$1.50 KI

WINDOW REGULATOR SCISSOR ASSEMBLY



Very nice copy of scissor assembly that allows door glass to move up and down.

Year	Description	Part No.	List
64-66	LH	C5ZZ-6523234-L	\$34. ⁹⁵ EA
64-66	RH	C5ZZ-6523234-R	\$34. ⁹⁵ EA

QUARTER WINDOW REGULATOR



Cadmium plated to prevent rust. Engineered for a perfect fit. Will not self destruct like others.

Year	Description	Part No.	List
64-67	LH	C5ZZ-6530306-L	\$59. ⁹⁵ EA
64-67	RH	C5ZZ-6530306-R	\$59. ⁹⁵ EA
68	LH	C8ZZ-6530306-L	\$59. ⁹⁵ EA
68	RH	C8ZZ-6530306-R	\$59. ⁹⁵ EA
69-70	LH	C9ZZ-6530306-L	\$79. ⁹⁵ EA
69-70	RH	C9ZZ-6530306-R	\$79. ⁹⁵ EA
71-73	LH	D1ZZ-6530306-L	\$79. ⁹⁵ EA
71-73	RH	D1ZZ-6530306-R	\$79. ⁹⁵ EA

WINDOW ROLLER & CLIP



Used on door and quarter window regulators scissors. Replacement makes window glass move easier. Now made by Drake this part features correct blue color and correct shape wire clip to prevent "pop offs" like other reproductions.

Year	Part No.	List
64-68	C0AB-6423240-B	\$1. ⁰⁰ EA

DOOR WINDOW CRANK

Highly detailed die-cast zinc construction. Finished in beautiful chrome or satin. Our handle feature much better detail than others.



64-65
Early 65, chrome
C4SZ-6323342-A

List
\$11.⁹⁵EA



65-67
Late 65, chrome
C5ZZ-6523342-C

List
\$11.⁹⁵EA



65-67
Late 65, satin
C5ZZ-6523342-S

List
\$13.⁹⁵EA



68-70
Chrome
C8AZ-6223342-A

List
\$11.⁹⁵EA



68-70
Chrome w/black knob
C8AZ-6223342-BK

List
\$18.⁹⁵EA



68-70
Satin
C8AZ-6223342-S

List
\$13.⁹⁵EA



1971-72
(Will also fit 1973): Chrome
C9UZ-8223342

List
\$11.⁹⁵EA

QUARTER WINDOW CRANK

Quarter window crank handle, made by Scott Drake. Like all our handles, these feature better detail and better chrome than competitors.



64-65
Early 65, chrome
C4SZ-6530322-A

List
\$13.⁹⁵EA



65-67
Late 65, chrome
C5ZZ-6530322-A

List
\$13.⁹⁵EA



65-67
Late 65, satin
C5ZZ-6530322-S

List
\$15.⁹⁵EA



68-70
Chrome
C8ZZ-6530322-A

List
\$11.⁹⁵EA



68-70
Chrome w/Black Knob
C8ZZ-6530322-BK

List
\$18.⁹⁵EA

QUARTER PANEL WINDOW HANDLES



A nice Reproduction. Die cast construction with good chrome plating. Hardware included.

Year	Description	Part No.	List
69-70	Chrome plated	C9ZZ-6330204/52	\$34. ⁹⁵ SE

WINDOW ANCHOR BOLT



The 1969-70 Mustang Fastback 1/4 Window Anchor Bolt is a special stainless steel capped bolt that is seen

from the outside of the car and goes through the quarter window glass where the handle is attached. It includes a special nut and two molded rubber pieces that seal between the bolt and the glass. Very nice to have when replacing the handles as originals are usually rusted. Two (2) are required per car.

Year	Description	Part No.	List
69-70	Fastback	C9ZZ-6330252-K	\$34. ⁹⁵ EA

INSIDE DOOR HANDLE & WINDOW CRANK SCREW

We have these exact reproductions made especially for us.



65-66
Chrome set of 4
379259-S

List
\$4.⁰⁰SE



67-70
Set of 4
381571-S

List
\$1.⁹⁵SE

DOOR HANDLE & WINDOW CRANK SPRING



Black lacquer finished to prevent rust. Year behind door panel

Year	Part No.	List
64-67	B7A-7022624-A	\$1. ²⁵ EA

DOOR HANDLE CLIP REMOVER



Removes special retaining clip on early door handles and window cranks. Stamped steel construction.

Year	Part No.	List
64-65	T-87600	\$7. ⁹⁵ EA

WE PROUDLY FEATURE AUTHENTIC MUSTANG REPRODUCTIONS FROM SCOTT DRAKE!



DOOR HANDLE SPRING CLIP



Small spring clip, copper plated just like the originals. Used to attach door handle and window crank to door shaft.

Year	Part No.	List
64-65	357550-S	\$0.30 ^{EA}

PONY DOOR HANDLE BACKING PLATE



Die cast and chrome plated. New improved design is very wear resistant. Also included are nylon bushings to prevent scratches.

Year	Description	Part No.	List
65-66	Chrome	C4SY-6322620/1A	\$10.95 ^{SE}
65-66	Satin	C4SY-6322620/1S	\$11.95 ^{SE}

WHITE, INSIDE WINDOW CRANK & DOOR HANDLE BACKING PLATE



Protects door panels from the abrasive action of rotating handles. Made from a very hard nylon type material. Ours feature the correct milky white color.

Year	Description	Part No.	List
64	Door	C3AZ-6223370-A	\$0.90 ^{EA}
65-70	Door	C5AZ-6223370-A	\$0.90 ^{EA}
64-67	Qtr windw	C4SZ-6323370-A	\$0.90 ^{EA}
68-73	Door	C8AZ-6223370-A	\$0.90 ^{EA}

CHROME, INSIDE WINDOW CRANK BACKING PLATE



The original plates are either missing, cracked or no longer chrome. Our plates are made with a bright chrome finish to really catch the eye.

Year	Description	Part No.	List
69-70	Chrome	C9Z-6523370-A	\$9.95 ^{PR}

WINDOW CRANK HANDLE COVER PLATE



This is a aluminum disc that covers the window crank handle screw hole. Stamped aluminum with circular brushed finish and adhesive backed.

Year	Part No.	List
68-73	C8AZ-6223362-A	\$1.25 ^{EA}

WINDOW CRANK KNOB



A premium reproduction. The knob is vinyl-molded and has a plastic insert just like the original. Mounting pin &

wave washer also included. will not fit original 1973 handles.

Year	Description	Part No.	List
68-72	Black	C8AZ-6223352-BK	\$6.95 ^{EA}
68-72	Blue	C8AZ-6223352-BL	\$7.50 ^{EA}
68-70	Clear/Silver	C8AZ-6223352-CL	\$7.50 ^{EA}
68-72	Ginger	C8AZ-6223352-GI	\$7.50 ^{EA}
68-72	Green	C8AZ-6223352-GR	\$7.50 ^{EA}
68-70	Ivy Gold	C8AZ-6223352-IG	\$7.50 ^{EA}
68-70	Maroon	C8AZ-6223352-MR	\$7.50 ^{EA}
68-69	Parchment & Nug Gold	C8AZ-6223352-PR	\$7.50 ^{EA}
68-72	Vermillion	C8AZ-6223352-VE	\$7.50 ^{EA}
68-72	White	C8AZ-6223352-WT	\$7.50 ^{EA}

DOOR HINGES & STRIKERS

DOOR HINGES



Reproduction cast-iron or stamped steel door hinges that look and work right. Painted black.

Year	Description	Part No.	List
64-66	RH, upper	C5Z-6522800-BR	\$29.95 ^{EA}
64-66	LH, upper	C5Z-6522801-BR	\$29.95 ^{EA}
64-66	RH, lower	C5Z-6522810-BR	\$32.95 ^{EA}
64-66	LH, lower	C5Z-6522811-BR	\$32.95 ^{EA}
67-68	RH, upper	C7Z-6522800-C	\$59.95 ^{EA}
67-68	LH, upper	C7Z-6522801-C	\$59.95 ^{EA}
67-68	RH, lower	C7Z-6522810-CR	\$59.95 ^{EA}
67-68	LH, lower	C7Z-6522811-CR	\$59.95 ^{EA}
69-70	RH, lower	C9Z-6522810-A	\$64.95 ^{EA}
69-70	LH, lower	C9Z-6522811-A	\$64.95 ^{EA}
69-70	RH, upper	D0Z-6522800-A	\$64.95 ^{EA}
69-70	LH, upper	D0Z-6522801-A	\$64.95 ^{EA}
71-73	RH, upper	D10Z-6522800-A	\$58.95 ^{EA}
71-73	LH, upper	D10Z-6522801-A	\$58.95 ^{EA}
71-73	RH, lower	D10Z-6522810-A	\$72.95 ^{EA}
71-73	LH, lower	D10Z-6522811-A	\$72.95 ^{EA}

DOOR HINGE MOUNT KIT



OE looking bolts with built in washers. Black oxide finish.

Year	Description	Part No.	List
64-65	6 bolts, black, 3/8" threads	379043-SMK	\$5.95 ^{KI}
66-68	6 bolts, black, 5/16" threads	380575-S2	\$4.95 ^{KI}

DOOR HINGE BUSHING



Machined brass to original factory specs. Requires 2 per pin.

Year	Part No.	List
64-73	C3AZ-5422841-A	\$1.00 ^{EA}

DOOR HINGE PIN



Machined just like the original. 4" version is cut to fit on early cars. 3"

version has concurs correct head marking for 1969-70.

Year	Description	Part No.	List
64-68	2 1/2"	B9A-5943030-AA	\$2.00 ^{EA}
64-73	4" cut to fit	B9A-5943030-LG	\$2.50 ^{EA}
69-70	3" Concours	B9A-5943030-MD	\$2.95 ^{EA}

DOOR HINGE REPAIR KIT



Contains all necessary parts including pins, bushings, a new cam plate, spring, and roller to rebuild both upper and lower hinges.

Year	Part No.	List
64-67	C5Z-6522800-K	\$22.95 ^{KI}

DOOR HINGE REPAIR SPRING



Spring to reload tension in door hinge. Compression tool also available.

Year	Part No.	List
64-68	C0DZ-6421232-B	\$1.50 ^{EA}

STRIKER ASSEMBLY



64-66
Gold zinc, Date coded 1-65
C20Z-6222008-B

List
\$12.95^{SE}



Original factory type striker. Includes attaching parts.

Year	Description	Part No.	List
67	Silver zinc, date coded 8-66	C5AZ-6222008-A	\$14.95 ^{SE}
68-70	Silver zinc, date coded 11-67	C5AZ-6222008-B	\$14.95 ^{SE}



71-80
Silver zinc
D2AZ-6522008-A

List

\$10⁹⁵ EA

STRIKER PLATE SCREW



Gold cadmium plated screws to attach door strikers.

Year	Description	Part No.	List
64-70	Set of 4	378428-S	\$3 ⁵⁰ SE

POLISHED STAINLESS STEEL STRIKER ASSEMBLY



New by Drake, these Mustang Door Strikers feature highly polished stainless steel for that perfect finish. Includes stainless steel hardware.

Year	Description	Part No.	List
64-66	Set of 2	C2OZ-6222008-SS	\$59 ⁹⁵ SE
67-70	Set of 2	C5AZ-6222008-SS	\$59 ⁹⁵ SE

OUTSIDE HANDLES

1964-70 CONCOURS OUTSIDE DOOR HANDLES

Made by Scott Drake, these show-quality Concours Door Handles are the absolute best on the market. Kits include handles, buttons, pads, hardware, and brackets. Available in 3 finishes for an original or custom look: chrome, satin chrome, or black chrome.



Year	Description	Part No.	List
64-66	Chrome	C4DZ-6222404/5P	\$64 ⁹⁵ KI
64-66	Satin chrome	C4DZ-6222404/5S	\$69 ⁹⁵ KI
67-68	Chrome	C7ZZ-6522404-5P	\$64 ⁹⁵ KI
67-68	Satin chrome	C7ZZ-6522404-5S	\$69 ⁹⁵ KI
69-70	Chrome	C9ZZ-6222404/5P	\$69 ⁹⁵ KI
69-70	Satin chrome	C9ZZ-6222404/5S	\$69 ⁹⁵ KI

ECONOMY OUTSIDE DOOR

HANDLES



Good quality & economically priced for the value-minded shopper. Kit includes both left and right handles, buttons,

pads, hardware and brackets. NOTE: for 69-70 MUST RE-USE ORIGINAL PIVOT MECHANISM as kit comes with 64-66 style. Concours Correct 69-70 Door Handle Kits are available.

Year	Desc	Part No.	List
64-66 & 69-70	Economy	C4DZ-6222404/5A	\$26 ⁹⁵ KI
67-68	Economy	C7ZZ-6522404/5A	\$28 ⁹⁵ KI

1971-73 OUTSIDE DOOR HANDLES



Quality reproductions. Includes handles for Left Hand & Right Hand doors and features a bright chrome finish.

Year	Part No.	List
71-73	D1ZZ-6222404/5A	\$74 ⁹⁵ PR

OUTSIDE DOOR HANDLE PAD



Fit between door handle and door body panel. Injection-molded plastic just like the original. Sold in complete sets only. 4 piece sets.

Year	Part No.	List
64-66 & 69-70	CODZ-6422428/9K	\$4 ⁰⁰ SE
67-68	C7ZZ-6522428/9K	\$4 ⁰⁰ SE

DOOR LATCHES & LOCKS

DOOR LATCH



This door latch assembly is a beautiful copy of a complicated stamping. Comes fully assembled and ready to install.

Year	Description	Part No.	List
65-66	RH	C4SZ-6321812-C	\$59 ⁹⁵ EA
65-66	LH	C4SZ-6321813-C	\$59 ⁹⁵ EA
67-68	RH	C60Z-6221812-A	\$65 ⁹⁵ EA
67-68	LH	C60Z-6221813-A	\$65 ⁹⁵ EA
69-70	RH	C9AZ-6221812-A	\$74 ⁹⁵ EA
69-70	LH	C9AZ-6221813-A	\$74 ⁹⁵ EA

DOOR LATCH REINFORCEMENT KIT



Door Latch Reinforcement Kit Does Both Doors, 12 piece kit includes 6 bolts and 6 washers. See "Keys, Locks, & Latches" for repair plates.

Year	Part No.	List
64-70	C0DB-3447	\$7 ⁹⁵ KI

DOOR LATCH RETAINER BUSHING KIT



Door Latch Retainer Bushing. 4 piece kit.

Year	Part No.	List
64-66	C4SZ-6321801-C	\$4 ⁹⁵ KI

DOOR LATCH ROD RETAINER



65-66
White economy replacement
C3AZ-6221952-A

List

\$2²⁵ EA



64-66
Concours
C3AZ-6221952-BR

List

\$4⁹⁵ EA



67-73
Concours
C5AZ-6221952-AR

List

\$4⁹⁵ EA

DOOR LOCK RODS



Zinc plated rods with correct bends.

Year	Description	Part No.	List
65-66	LH, set of 3	C5ZZ-65213452LH	\$24 ⁹⁵ SE
65-66	RH, set of 3	C5ZZ-65213452RH	\$24 ⁹⁵ SE
67-68	LH, set of 3	C7ZZ-65213452LH	\$24 ⁹⁵ SE
67-68	RH, set of 3	C7ZZ-65213452RH	\$24 ⁹⁵ SE

DOOR LOCK/LATCH ROD SET



Complete set of door latch and lock rods for both doors. Includes retaining clips.

Year	Part No.	List
67-68	C7ZZ-6521940-KT	\$79 ⁹⁵ SE
69-70	C9ZZ-6521940-KT	\$79 ⁹⁵ SE

WE PROUDLY FEATURE AUTHENTIC MUSTANG REPRODUCTIONS FROM SCOTT DRAKE!



DOOR LATCH SCREW



Correct screws with special star washers. Set of six.

Year	Description	Part No.	List
64-70	Set of 6	356782-S	\$3.75 KI

DOOR LATCH SPRING



Correct stainless steel spring for door latch. This part is often broken and preventing latch from working properly.

Year	Part No.	List
67-70	357212-S	\$7.50 EA

DOOR & IGNITION LOCK KIT



Convenient matched kits save costly locksmith work. Kits include a pair of door lock cylinders and an ignition cylinder.

Comes with two keys. 1967 - 1969 include door cylinder gaskets. See "Keys, Locks, & Latches" for complete listing of Door Locks.



Year	Description	Part No.	List
64-66	Standard keys	CSDZ-6222050-A	\$32.95 SE
65-66	Pony keys OLP	CSDZ-6222050-B	\$36.95 EA
67-69	Standard keys	C9AZ-6222050-A	\$27.95 SE
67-69	Pony keys OLP	C9AZ-6222050-B	\$30.95 SE
70-73	Standard keys	D2AZ-6222050-A	\$29.95 SE

DOOR LOCK KNOB

Made by Plastic injection. Sold as a pair. Available in chrome, or satin chrome.



64½
Black
C3AZ-6221850-BK

List
\$7.50 EA



65-66
Chrome
CSDZ-6221850-A

List
\$5.00 PR



65-66
Satin chrome
CSDZ-6221850-S

List
\$5.00 PR



67
Chrome
C5AZ-6221850-A

List
\$6.00 PR



68-73
Chrome, concours
C8AZ-6221850-A

List
\$5.00 PR

DOOR LOCK KNOB GROMMET

The grommet that goes around the door lock knob, comes in clear, chrome or stainless.



64½: All
Black plastic
C2OZ-6221999-BK

List
\$4.95 EA



65-68: All 69-73
Standard interior Clear plastic
C5DZ-6221999-B

List
\$0.75 EA



65-68: All 69-73
Standard interior Chrome
C5DZ-6221999-C

List
\$3.50 PR



69-73
Deluxe interior Stainless steel
D0DZ-6221999-AR

List
\$6.95 PR

DOOR PANELS & ARMRESTS

1964-65 STANDARD DOOR PANELS

Our door panels are upholstered with the original material, mounted on precision die-cut fiberboard. Colors and textures are identical to the originals. Includes chrome plated plastic trim where appropriate.



Year	Description	Part No.	List
64-65	Black	C5ZL-65239423BK	\$74.95 PR
64-65	Blue	C5ZL-65239423BL	\$74.95 PR
64-65	Ivy gold	C5ZL-65239423IG	\$74.95 PR
64-65	Palamino	C5ZL-65239423PA	\$74.95 PR
64-65	Red	C5ZL-65239423RD	\$74.95 PR
64-65	White	C5ZL-65239423WT	\$74.95 PR

1965-66 DELUXE DOOR PANELS



These panels are the finest available. Excellent molded vinyl surface with the correct grain. Foam filled on treated pressboard. These door panels DO NOT include stainless steel trim pieces.



Year	Description	Part No.	List
65-66	Black	C5ZZ65239423BKP	\$179.95 PR
66	Dark red	C5ZZ65239423DRP	\$179.95 PR
66	Parchment	C5ZZ65239423PRP	\$179.95 PR
65	Bright red	C5ZZ65239423RDP	\$179.95 PR
65-66	White	C5ZZ65239423WTP	\$179.95 PR

1966 STANDARD DOOR PANELS



Our door panels are upholstered with the original material, mounted on precision die-cut fiberboard. Colors and textures are identical to the originals. Includes chrome plated plastic trim where appropriate.



Year	Description	Part No.	List
66	Black	C6ZZ-65239423BK	\$74.95 PR
66	Aqua	C6ZZ-65239423AQ	\$74.95 PR
66	Blue	C6ZZ-65239423BL	\$74.95 PR
66	Dark red	C6ZZ-65239423DR	\$74.95 PR
66	Parchment	C6ZZ-65239423PR	\$74.95 PR

1967 STANDARD DOOR PANELS



Our door panels are upholstered with the original material, mounted on precision die-cut fiberboard. Colors and textures are identical to the originals. Includes chrome plated plastic trim where appropriate.



Year	Description	Part No.	List
67	Black	C7ZZ-65239423BK	\$74.95 PR
67	Aqua	C7ZZ-65239423AQ	\$74.95 PR
67	Blue	C7ZZ-65239423BL	\$74.95 PR
67	Ivy gold	C7ZZ-65239423IG	\$74.95 PR
67	Parchment	C7ZZ-65239423PR	\$74.95 PR
67	Red	C7ZZ-65239423RD	\$74.95 PR
67	Saddle	C7ZZ-65239423SA	\$74.95 PR



For TMI Door Panels
see page 168

1967 DELUXE DOOR PANELS



These panels are the finest available. Excellent molded vinyl surface with the correct grain. Foam filled on treated pressboard. These door panels do not include stainless steel trim pieces, or aluminum inserts.



Year	Description	Part No.	List
67	Black	C7Z65239423BKD	\$209 ⁹⁵ PR
67	Blue	C7Z65239423BLD	\$209 ⁹⁵ PR
67	Ivy gold	C7Z65239423IGD	\$209 ⁹⁵ PR
67	Parchment	C7Z65239423PRD	\$209 ⁹⁵ PR
67	Red	C7Z65239423RDD	\$209 ⁹⁵ PR

1965-67 2-TONE STANDARD DOOR PANELS

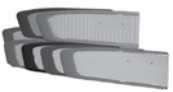

Two-tone panels are available in a variety of color combinations.



Year	Description	Part No.	List
65	Blue/white	C5Z65239423B/W	\$109 ⁹⁵ PR
65	Black/white	C5Z65239423BKW	\$102 ⁵⁰ PR
65	Ivy gold/white	C5Z65239423I/W	\$109 ⁹⁵ PR
65	Palamino/white	C5Z65239423P/W	\$109 ⁹⁵ PR
65	Bright red/white	C5Z65239423R/W	\$109 ⁹⁵ PR
66	Aqua/white	C6Z65239423A/W	\$109 ⁹⁵ PR
66	Blue/white	C6Z65239423B/W	\$109 ⁹⁵ PR
66	Black/white	C6Z65239423BKW	\$102 ⁵⁰ PR
66	Light blue/white	C6Z65239423LBW	\$102 ⁵⁰ PR
66	Parchment/white	C6Z65239423P/W	\$109 ⁹⁵ PR
66	Dark red/white	C6Z65239423R/W	\$109 ⁹⁵ PR
67	Aqua/white	C7Z65239423A/W	\$102 ⁵⁰ PR
67	Blue/white	C7Z65239423B/W	\$109 ⁹⁵ PR
67	Black/white	C7Z65239423BKW	\$102 ⁵⁰ PR
67	Ivy gold/white	C7Z65239423I/W	\$109 ⁹⁵ PR
67	Parchment/white	C7Z65239423P/W	\$109 ⁹⁵ PR
67	Dark red/white	C7Z65239423R/W	\$109 ⁹⁵ PR
67	Saddle/white	C7Z65239423S/W	\$102 ⁵⁰ PR

1968 STANDARD DOOR PANELS



Our door panels are upholstered with the original material, mounted on precision die-cut fiberboard. Colors and textures are identical to the originals. Includes chrome plated plastic trim where appropriate.



Year	Description	Part No.	List
68	Black	C8Z65239423BK	\$74 ⁹⁵ PR
68	Blue	C8Z65239423BL	\$74 ⁹⁵ PR
68	Ivy gold	C8Z65239423IG	\$74 ⁹⁵ PR
68	Maroon	C8Z65239423MR	\$74 ⁹⁵ PR
68	Nugget gold	C8Z65239423NG	\$74 ⁹⁵ PR
68	Parchment	C8Z65239423PR	\$74 ⁹⁵ PR
68	Saddle	C8Z65239423SA	\$74 ⁹⁵ PR

1968 DELUXE DOOR PANELS



These panels are the finest available. Chrome trim and woodgrain inserts installed as original.



Year	Description	Part No.	List
68	Black	C8Z65239423BKD	\$174 ⁹⁵ PR
68	Aqua	C8Z65239423AQD	\$174 ⁹⁵ PR
68	Blue	C8Z65239423BLD	\$174 ⁹⁵ PR
68	Ivy gold	C8Z65239423IGD	\$174 ⁹⁵ PR
68	Maroon	C8Z65239423MRD	\$174 ⁹⁵ PR
68	Nugget gold	C8Z65239423NGD	\$174 ⁹⁵ PR
68	Parchment	C8Z65239423PRD	\$174 ⁹⁵ PR
68	Saddle	C8Z65239423SAD	\$174 ⁹⁵ PR

1969 STANDARD DOOR PANELS



Our door panels are upholstered with the original material, mounted on precision die-cut

fiberboard. Colors and textures are identical to the originals. Includes chrome plated plastic trim where appropriate.



Year	Description	Part No.	List
69	Black	C9Z65239423BK	\$76 ⁹⁵ PR
69	Dark ivy gold	C9Z65239423DI	\$76 ⁹⁵ PR
69	Dark red	C9Z65239423DR	\$76 ⁹⁵ PR
69	Light blue	C9Z65239423LB	\$76 ⁹⁵ PR
69	Nugget gold	C9Z65239423NG	\$76 ⁹⁵ PR
69	White	C9Z65239423WT	\$76 ⁹⁵ PR

1969-70 DELUXE DOOR PANELS



These panels are the finest available. Excellent molded vinyl surface with the correct grain. Foam filled on treated

pressboard. These door panels do not include stainless steel trim pieces, or aluminum inserts. Some cutting may be required.



Year	Description	Part No.	List
69	Black w/ black carpet	C9Z65239423BKD	\$404 ⁹⁵ PR
69	Dark red w/ maroon carpet	C9Z65239423DRD	\$409 ⁹⁵ PR
69	White w/ black carpet	C9Z65239423WTD	\$404 ⁹⁵ PR
70	Med blue w/ blue carpet	C9Z65239423BLD	\$409 ⁹⁵ PR
70	Black w/ black carpet	D0Z65239423BKD	\$404 ⁹⁵ PR
70	Ginger w/ drk brown carpet	D0Z65239423GID	\$404 ⁹⁵ PR
70	White w/ black carpet	D0Z65239423WTD	\$404 ⁹⁵ PR

1970 STANDARD DOOR PANELS



Our door panels are upholstered with the original material, mounted on precision die-cut fiberboard. Colors and textures are

identical to the originals. Includes chrome plated plastic trim where appropriate.



Part No.	Year	Description	List
D0ZZ-65239423BK	70	Black	\$106 ⁹⁵ PR
D0ZZ-65239423BL	70	Blue	\$106 ⁹⁵ PR
D0ZZ-65239423BR	70	Bright red	\$106 ⁹⁵ PR
D0ZZ-65239423IG	70	Ivy gold	\$106 ⁹⁵ PR
D0ZZ-65239423WT	70	White	\$106 ⁹⁵ PR

1971-73 STANDARD DOOR PANELS

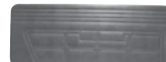

Our door panels are upholstered with the original material, mounted on precision die-cut fiberboard. Colors and

textures are identical to the originals. Includes chrome plated plastic trim where appropriate.



Part No.	Year	Description	List
D1ZZ-65239423BK	71-73	Black	\$114 ⁹⁵ PR
D1ZZ-65239423BL	71-73	Blue	\$114 ⁹⁵ PR
D1ZZ-65239423BR	71-73	Bright red	\$114 ⁹⁵ PR
D1ZZ-65239423GI	71-73	Ginger	\$114 ⁹⁵ PR
D1ZZ-65239423GR	71-73	Green	\$114 ⁹⁵ PR
D1ZZ-65239423IG	71-73	Ivy gold	\$114 ⁹⁵ PR
D1ZZ-65239423WT	71-73	White	\$114 ⁹⁵ PR

1971-73 DELUXE DOOR PANELS



These panels are the finest available. Excellent molded vinyl surface with the correct grain. Foam filled on treated

pressboard. These door panels do not include stainless steel trim pieces, or aluminum inserts.



Year	Description	Part No.	List
71-73	Black	D1ZZ65239423BKD	\$434 ⁹⁵ PR
71-73	Medium blue	D1ZZ65239423BLD	\$434 ⁹⁵ PR
71-73	Ginger	D1ZZ65239423GID	\$434 ⁹⁵ PR
71-73	White	D1ZZ65239423WTD	\$434 ⁹⁵ PR

WE PROUDLY FEATURE AUTHENTIC MUSTANG REPRODUCTIONS FROM SCOTT DRAKE!



DOOR WATERSHIELD



Protects door panels and upholstery from water damage. Specially treated paper, precisely die-cut for an easy installation. CRL-

7708 Sealer recommended for installation (can be found towards the end of "Door Parts").



Part No.	Year	Description	List
C5ZZ-63-WS	65-66	Fastback	\$10.95 ^{KI}
C5ZZ-65-WS	64-66	Coupe	\$14.50 ^{KI}
C5ZZ-76-WS	64-66	Convertible	\$14.50 ^{KI}
C7ZZ-63-WS	67-68	Fastback	\$10.95 ^{KI}
C7ZZ-65-WS	67-68	Coupe	\$14.50 ^{KI}
C7ZZ-76-WS	67-68	Convertible	\$14.50 ^{PR}
C9ZZ-63-WS	69-70	Fastback	\$10.95 ^{KI}
C9ZZ-65-WS	69-70	Coupe	\$14.50 ^{KI}
C9ZZ-76-WS	69-70	Convertible	\$14.50 ^{KI}
D1ZZ-63-WS	71-73	Fastback	\$14.50 ^{SE}
D1ZZ-65-WS	71-73	Coupe	\$14.50 ^{SE}
D1ZZ-76-WS	71-73	Convertible	\$14.50 ^{SE}

DOOR PANEL CLIPS



High quality door panel clips in bulk or nicely packaged in a set of 30. 64-68 requires 30 clips, 69-70 requires 28 clips, and 71-73 requires 20. Standard clips are also used for seat backs.

Year	Description	Part No.	List
64-70	Standard, set of 30, also Year 68 Deluxe	380552-K	\$9.95 ^{SE}
64-73	Standard, bulk, also Year 68 Deluxe	380552-S	\$0.35 ^{EA}
65-67	Deluxe, set of 30	375553-K	\$11.95 ^{SE}
65-67	Deluxe, bulk	375553-S	\$0.40 ^{EA}
69-70	Deluxe screws & clips, set of 36	375553-69D	\$10.95 ^{SE}

ARM REST BASE



Precision molded of stress-resistant plastic, with a smooth durable chrome finish. See "Hardware"

section for special mounting screws and retaining clip.

Part No.	Year	List
C5ZZ-6524144-A	64-66	\$5.95 ^{EA}

ARM REST BASE AND PAD KIT



Each kit contains a pair of arm rest pads and bases. Arm rest pads feature correct texture and molded in color. Steel insert for

strength. Extra thick vinyl skin. Base is precision molded of stress resistant plastic with a smooth chrome finish. Kit includes all mounting screws.

Part No.	Year	Description	List
KIT-INT-2-BK	64-66	Black	\$29.95 ^{KI}
KIT-INT-2-BL	64-66	Medium blue	\$29.95 ^{KI}
KIT-INT-2-BR	64-65	Bright red	\$29.95 ^{KI}
KIT-INT-2-DB	66	Dark blue	\$29.95 ^{KI}
KIT-INT-2-DR	66	Dark red	\$29.95 ^{KI}
KIT-INT-2-WT	64-65	White	\$29.95 ^{KI}

1964-66 ARM REST PAD



Correct texture and molded-in colors, with steel insert molded into foam to increase strength. Extra thick vinyl skins. American

made. See "Hardware" section for special mounting screws and retaining clip.

Year	Description	Part No.	List
64-66	Black	C5ZZ-6524100-BK	\$10.95 ^{EA}
66	Aqua	C5ZZ-6524100-AQ	\$10.95 ^{EA}
64-65	Medium blue	C5ZZ-6524100-BL	\$10.95 ^{EA}
64-65	Bright red	C5ZZ-6524100-BR	\$10.95 ^{EA}
66	Dark blue	C5ZZ-6524100-DB	\$10.95 ^{EA}
66	Dark red	C5ZZ-6524100-DR	\$10.95 ^{EA}
64-66	Ivy gold	C5ZZ-6524100-IG	\$10.95 ^{EA}
64-65	Palomino	C5ZZ-6524100-PA	\$10.95 ^{EA}
66	Parchment	C5ZZ-6524100-PR	\$10.95 ^{EA}
64-65	White	C5ZZ-6524100-WT	\$10.95 ^{EA}

1967 ARM REST PAD



Correct texture and molded-in colors, with steel insert molded into foam to increase strength.

Extra thick vinyl skins. American made. See "Hardware" section for special mounting screws and retaining clip.

Year	Desc	Part No.	List
67	Black	C7ZZ-6524100-BK	\$19.95 ^{EA}
67	Red	C7ZZ-6524100-RD	\$19.95 ^{EA}
67	Blue	C7ZZ-6524100-BL	\$19.95 ^{EA}
67	Aqua	C7ZZ-6524100-AQ	\$23.95 ^{EA}
67	Ivy gold	C7ZZ-6524100-IG	\$23.95 ^{EA}
67	Parchment	C7ZZ-6524100-PR	\$23.95 ^{EA}
67	Saddle	C7ZZ-6524100-SA	\$23.95 ^{EA}

1968 ARM REST PAD



Correct texture and molded-in colors, with steel insert molded into foam to increase strength.

Extra thick vinyl skins. American made. See "Hardware" section for special mounting screws and retaining clip.

Year	Description	Part No.	List
68	Black, RH	C8ZZ-6524100-BK	\$23.95 ^{EA}
68	Black, LH	C8ZZ-6524101-BK	\$23.95 ^{EA}
68	Red, RH	C8ZZ-6524100-RD	\$23.95 ^{EA}
68	Red, LH	C8ZZ-6524101-RD	\$23.95 ^{EA}
68	Blue, RH	C8ZZ-6524100-BL	\$23.95 ^{EA}
68	Blue, LH	C8ZZ-6524101-BL	\$23.95 ^{EA}
68	Aqua, RH	C8ZZ-6524100-AQ	\$26.95 ^{EA}
68	Aqua, LH	C8ZZ-6524101-AQ	\$26.95 ^{EA}
68	Ivy gold, RH	C8ZZ-6524100-IG	\$26.95 ^{EA}
68	Ivy gold, LH	C8ZZ-6524101-IG	\$26.95 ^{EA}
68	Parchment, RH	C8ZZ-6524100-PR	\$26.95 ^{EA}
68	Parchment, LH	C8ZZ-6524101-PR	\$26.95 ^{EA}
68	Saddle, RH	C8ZZ-6524100-SA	\$26.95 ^{EA}
68	Saddle, LH	C8ZZ-6524101-SA	\$26.95 ^{EA}

1968 DELUXE ARM REST PAD



Correct texture and molded-in colors, with steel insert molded into foam to increase strength.

Extra thick vinyl skins. American made. See "Hardware" section for special mounting screws and retaining clip. Plugs sold separately.

Year	Description	Part No.	List
68	Black, RH	C8ZZ-6524100BKD	\$64.95 ^{EA}
68	Black, LH	C8ZZ-6524101BKD	\$64.95 ^{EA}
68	Blue, RH	C8ZZ-6524100BLD	\$66.95 ^{EA}
68	Blue, LH	C8ZZ-6524101BLD	\$66.95 ^{EA}
68	Aqua, RH	C8ZZ-6524100AQD	\$66.95 ^{EA}
68	Aqua, LH	C8ZZ-6524100AQD	\$66.95 ^{EA}
68	Ivy gold, RH	C8ZZ-6524100IGD	\$66.95 ^{EA}
68	Ivy gold, LH	C8ZZ-6524101IGD	\$66.95 ^{EA}
68	Maroon, RH	C8ZZ-6524100MRD	\$66.95 ^{EA}
68	Maroon, LH	C8ZZ-6524101MRD	\$66.95 ^{EA}
68	Parchment, RH	C8ZZ-6524100PRD	\$66.95 ^{EA}
68	Parchment, LH	C8ZZ-6524101PRD	\$66.95 ^{EA}
68	Saddle, RH	C8ZZ-6524100SAD	\$66.95 ^{EA}
68	Saddle, LH	C8ZZ-6524101SAD	\$66.95 ^{EA}

1969-70 ARM REST PAD



Correct texture and molded-in colors, with steel insert molded into foam to increase strength.

Extra thick vinyl skins. American made. Note: Ford used 2 different arm rest pads in 69-70. We currently offer only 1 version. Mounting holes are approximately 12 1/4" from center to center on our pads. Some cars measured approximately 13". These cars will require relocating one mounting hole before door panel is installed.

Year	Description	Part No.	List
69-70	Black, RH	C9ZZ-6524100-BK	\$34.95 ^{EA}
69-70	Black, LH	C9ZZ-6524101-BK	\$34.95 ^{EA}
69-70	White, RH	C9ZZ-6524100-WT	\$39.95 ^{EA}
69-70	White, LH	C9ZZ-6524101-WT	\$39.95 ^{EA}

1971-73 ARM REST PAD



Correct texture and molded-in colors, with steel insert molded into foam to increase strength. Extra thick vinyl skins. American made.

Year	Description	Part No.	List
71-73	Black, RH	D1ZZ-6524100-BK	\$24.95 ^{EA}
71-73	Black, LH	D1ZZ-6524101-BK	\$24.95 ^{EA}
71-73	Blue, RH	D1ZZ-6524100-BL	\$24.95 ^{EA}
71-73	Blue, LH	D1ZZ-6524101-BL	\$24.95 ^{EA}
71-73	Ginger, RH	D1ZZ-6524100-GI	\$24.95 ^{EA}
71-73	Ginger, LH	D1ZZ-6524101-GI	\$24.95 ^{EA}

ARM REST PAD BASE



Year	Description	Part No.	List
71-73	Standard interior	D1AZ-5724144-A	\$13.95 ^{EA}

DELUXE ARM REST PLUG



Perfect detail in these often missing plugs. 67's fit into door panel, 68's fit into arm rest pad.

Year	Description	Part No.	List
67	Black, deluxe	C7ZZ-6524056-BK	\$6.95 ^{PR}
67	Parchment, deluxe	C7ZZ-6524056-PR	\$6.95 ^{PR}
68	Black, deluxe, set of 4	C8ZZ-6524056-BK	\$7.95 ST
68	Parchment, deluxe, set of 4	C8ZZ-6524056-PR	\$7.95 ST

1964-67 DELUXE DOOR PANEL CUPS



Perfect and color match. Ours are double dipped in textured vinyl just like originals.

Part No.	Year	Description	List
CSZZ-6524142-BK	65-67	Black	\$10.95 ^{EA}
CSZZ-6524142-BR	65	Bright red	\$12.95 ^{EA}
CSZZ-6524142-DR	66-67	Dark red	\$12.95 ^{EA}
CSZZ-6524142-PR	66-67	Parchment	\$12.95 ^{EA}
CSZZ-6524142-WT	65-66	White	\$10.95 ^{EA}

DELUXE DOOR PANEL KIT



Kit includes pads, cups, brackets and mounting hardware.

Year	Description	Part No.	List
65-66	Black	KIT-INT5-BK	\$32.95 ^{KI}
65-66	White	KIT-INT5-WT	\$32.95 ^{KI}

STANDARD DOOR PANEL CUP



Black plastic cup with correct texture and chrome beauty rings.

Year	Description	Part No.	List
69-70	Standard interior	C9ZZ-65226A34	\$22.95 ^{SE}

DELUXE DOOR HANDLE BEZEL



Trim behind door handle. Mounts on door before door panel is installed.

Year	Description	Part No.	List
69-70	Deluxe interior	C9ZZ-6522634-D	\$25.95 ^{PR}

DELUXE DOOR PANEL CUP BRACKET



New pressure die cast zinc construction just like the originals, but stronger.

Year	Description	Part No.	List
69	Black, pair	C9ZZ6524046/7BK	\$54.95 ^{PR}
69	White, pair	C9ZZ6524046/7WT	\$54.95 ^{PR}
69	Black, RH	C9ZZ-6524046-BK	\$34.95 ^{EA}
69	Black, LH	C9ZZ-6524047-BK	\$34.95 ^{EA}
69	White, LH	C9ZZ-6524047-WT	\$34.95 ^{EA}
70	Black, pair	D0ZZ-6524046/7B	\$54.95 ^{PR}
70	White, pair	D0ZZ-6524046/7W	\$54.95 ^{PR}

DELUXE DOOR PANEL CUP BRACKET



This support bracket is used to fasten the Pony door cups to the inner door on 1965-67 Deluxe interiors. It takes two of these per car.

Year	Part No.	List
65-67	CSZZ-6524140	\$4.50 ^{EA}



New by Drake, this set of 1969 and 1970 Deluxe Arm Rest Brackets is made from the original

Ford Factory Prints and feature attached threaded studs for an easier and more secure installation. Sold as a pair with all necessary hardware is included. Used in conjunction with Deluxe Door Cups.

Year	Part No.	List
69	C9ZZ-65240A10-A	\$19.95 ^{KI}
70	D0ZZ-65240A10-B	\$19.95 ^{KI}

DOOR PANEL CUP PAD



Textured rubber pad that covers the door cup mounting screws. Correct color match.

Year	Description	Part No.	List
65-67	Black	CSZZ-6324046-BK	\$3.95 ^{EA}
66-67	Parchment	CSZZ-6324046-PR	\$3.95 ^{EA}
65-66	White	CSZZ-6324046-WT	\$3.95 ^{EA}
69	Black	C9ZB-6524046/7B	\$12.95 ^{PR}
69	White	C9ZB-6524046/7W	\$12.95 ^{PR}
70	Black	D0ZB-6524046/7B	\$12.95 ^{PR}
70	White	D0ZB-6524046/7W	\$12.95 ^{PR}

DOOR PANEL EMBLEM



Beautiful detail. Features bright chrome finish and paint. Hardware included.

Year	Description	Part No.	List
69-70	69: All 70: Deluxe	C9ZB-6520820/3	\$23.95 ^{PR}



Door Parts

WE PROUDLY FEATURE AUTHENTIC MUSTANG REPRODUCTIONS FROM SCOTT DRAKE!



DOOR PANEL INSERT



These deluxe door panel inserts are made of high quality brushed aluminum or vinyl woodgrain..

Year	Description	Part No.	List
67	Brushed aluminum w/ correct polished raised bead & mounting spike	C7ZZ-65237A22/3	\$139. ⁹⁵ PR
67	Brushed aluminum w/ correct polished raised bead & mounting spikes w/ out remote mirror hole	C7ZZ-65237A22/3N	\$139. ⁹⁵ PR



Year	Description	Part No.	List
69-70	Walnut	C9ZZ-6523942/3W	\$29. ⁹⁵ PR
69-70	Teak	C9ZZ-6523942/3W	\$29. ⁹⁵ PR

DOOR PANEL INSERT W/ ALUMINUM PANEL



We have produced these panels from our own tooling with exact detailing right down to the black painted border. Included is a pair of high quality, adhesive backed, woodgrain vinyl inserts, available in dark walnut. Don't forget about our beautiful mustang emblems to finish off these panels.

Year	Description	Part No.	List
69-70	Walnut inserts	C9ZZ-6523942/3W	\$99. ⁹⁵ SE
69-70	Teak inserts	C9ZZ-6523942/3T	\$99. ⁹⁵ SE

DELUXE DOOR PANEL TRIM

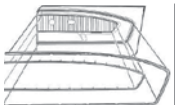

Made by Scott Drake, these Deluxe Door Panel Moldings are constructed of Stainless Steel. They feature all the exact detail of the original and are designed to fit new-reproduction deluxe panels.

Year	Description	Part No.	List
65-66	RH	C5ZZ-652042/70	\$60. ⁰⁰ SE
65-66	LH	C5ZZ-652043/71	\$60. ⁰⁰ SE
65-66	RH & LH	C5ZZ-652042/71S	\$120. ⁰⁰ SE
67	RH & LH outer only	C7ZZ-6520970/1	\$129. ⁹⁵ PR
69-70	RH & LH Mach Deluxe Door Trim	C9ZZ-6520970/1	\$224. ⁹⁵ PR

STANDARD DOOR INNER UPPER TRIM



Mounts on inside top part of door to finish door panel.

Year	Description	Part No.	List
69-70	Standard interior, RH	C9ZZ-6520904-A	\$94. ⁹⁵ EA
69-70	Standard interior, LH	C9ZZ-6520905-A	\$94. ⁹⁵ EA

DOOR PANEL U-CUP



Now made by Drake, these are great reproductions. Made from ABS plastic, these cups feature the correct texture on the inside and mounting pins just like the originals.

Year	Description	Part No.	List
67	Deluxe Interior, Black	C7ZZ-6524148-BK	\$44. ⁹⁵ PR
67	Deluxe Interior, Parchment	C7ZZ-6524148-PR	\$44. ⁹⁵ PR

DELUXE DOOR PULL



Exact reproduction of the originals. Exact detail of stitches and grain pattern.

Year	Description	Part No.	List
68	Black, pair	C8ZZ-6526656-BK	\$29. ⁹⁵ PR
68	Dark blue, pair	C8ZZ-6526656-BL	\$29. ⁹⁵ PR
68	Parchment, pair	C8ZZ-6526656-PR	\$29. ⁹⁵ PR
68	Saddle, pair	C8ZZ-6526656-SA	\$29. ⁹⁵ PR
71-73	Black, LH	D1ZZ-6526655-BK	\$56. ⁹⁵ EA
71-73	Blue, LH	D1ZZ-6526655-BL	\$56. ⁹⁵ EA
71-73	Ginger, LH	D1ZZ-6526655-GI	\$56. ⁹⁵ EA
71-73	Black, RH	D1ZZ-6526656-BK	\$56. ⁹⁵ EA
71-73	Blue, RH	D1ZZ-6526656-BL	\$56. ⁹⁵ EA
71-73	Ginger, RH	D1ZZ-6526656-GI	\$56. ⁹⁵ EA

DOOR PULL END CAP KIT



Our door pull end caps feature beautiful chrome and wood grain insert that matches the dash and door panel wood grain. We feel these look a lot nicer than the original. All mounting hardware included. Inner door braces sold separately.

Year	Description	Part No.	List
68	Deluxe interior	C7WY-6522670/6	\$42. ⁹⁵ SE

WOODGRAIN DOOR PULL INSERTS



These are the same inserts that are available in our complete door pull end cap kit, but now available on their own. Quickly and easily replace worn or missing inserts. Sold as a set of 4 inserts.

Year	Description	Part No.	List
68	Set of 4	C7WY-6522670-A	\$8. ⁹⁵ SE

INNER DOOR PULL BRACE



Exact reproduction. Includes mounting hardware and nylon inserts. Painted black.

Year	Description	Part No.	List
68	Deluxe interior	C8AZ-6522606-A	\$16. ⁹⁵ SE

DOOR SPEAKER GRILLES

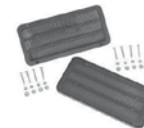

65-66
C6ZZ-18798-A

List
\$50. ⁹⁵ PR



69-70
Stereo script
C9ZZ-18798-A

List
\$44. ⁹⁵ PR



71-73
D2ZZ-18978-A

List
\$29. ⁹⁵ EA

1967-68 DOOR SPEAKER GRILLES



Made by Scott Drake, these 1967-68 Deluxe Door Speaker Grilles are a beautiful reproduction. They can also be installed on 1965-66 doors for a custom look. Use our Door Grille Mounting Kit (C7ZN-3301) for proper installation on doors originally equipped with these grilles.

Year	Description	Part No.	List
67-68	Deluxe, also fits 65-66 for a custom look	C7ZZ-6520956/7A	\$124. ⁹⁵ PR

DOOR COURTESY LIGHT ASSEMBLY

These assemblies feature bright white lenses, beautiful chrome plating, correct wiring and housing. Mounting hardware included. These are the best on the market. See "Electrical" for wire harness.

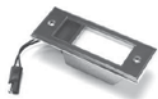

65-66
Deluxe
C5ZZ-13786

Year	Description	Part No.	List
65-66	Deluxe	C5ZZ-13786	\$34.95 ^{EA}



67-68
Deluxe
C7ZB-13A744-C

Year	Description	Part No.	List
67-68	Deluxe	C7ZB-13A744-C	\$32.50 ^{EA}



69-70
Deluxe, set of 2
C9WY-13776/7-A

Year	Description	Part No.	List
69-70	Deluxe, set of 2	C9WY-13776/7-A	\$79.95 ^{PR}

DOOR COURTESY LIGHT LENS



Replace those yellowed lenses with our clean white reproduction. Sold in matching pairs.

Year	Description	Part No.	List
67-68	Deluxe	C7ZZ-13731-B	\$19.95 ^{PR}

EXTERIOR DOOR PARTS, WEATHERSTRIP & WINDOWS

DOOR BUMPER



Made from first-class E.P.D.M. rubber. Usually eliminates door rattling by replacing those stone-hard originals. Available in bulk or sets of 4.

Year	Description	Part No.	List
64-68	Bulk	C2AZ-6223030-A	\$0.75 ^{EA}
64-68	Set of 4	C2AZ-6223030-K	\$3.95 ^{SE}
69-73	Set of 4	C7AZ-54265A28AA	\$3.95 ^{SE}

DOOR EDGE GUARD



Protects paint, made from rust resistant stainless steel.

Year	Part No.	List
64-66	C5ZZ-6520910/1	\$20.95 ^{PR}
67-68	C7ZZ-6520910/1	\$20.95 ^{PR}
69-70	C9ZZ-6520910/1	\$20.95 ^{PR}
71-73	D1ZZ-6520910/1	\$20.95 ^{PR}

FRONT DOOR GLASS RUN CHANNEL



Vertical channel which runs behind vent window that door glass slides in. Features original type mohair inside channel,

mounting bracket and stainless steel trim. 69-70 Door Glass Runs are all steel construction.

Year	Description	Part No.	List
64-66	USA	C5ZZ-6521538/9A	\$105.95 ^{PR}
64-66	Import	C5ZZ-6521538/9I	\$94.95 ^{PR}
64-66	Import, RH	C5ZZ-6521538-A	\$50.95 ^{EA}
64-66	Import, LH	C5ZZ-6521539-A	\$50.95 ^{EA}
69-70	RH, steel tube	C9ZZ-6521546-A	\$34.95 ^{EA}
69-70	LH, steel tube	C9ZZ-6521547-A	\$34.95 ^{EA}

VENT WINDOW CHANNEL



Steel channel with door glass run insert installed.

Year	Description	Part No.	List
67-68	RH	C7ZZ-6521538-A	\$47.95 ^{EA}
67-68	LH	C7ZZ-6521539-A	\$47.95 ^{EA}

FRONT DOOR GLASS RUN INSERTS



Insert to replace worn rubber and felt channel guide for door glass. Features original looking felt. Top molded pieces

are bonded securely and has steel inserts for added strength.

Year	Part No.	List
67-68	C7ZZ-6521546/7A	\$26.95 ^{PR}

DOOR GLASS RUNS



Year	Description	Part No.	List
69-70	RH	C9ZZ-6521546-A	\$34.95 ^{EA}
69-70	LH	C9ZZ-6521547-A	\$34.95 ^{EA}

DOOR GLASS RUN GUIDE



Prevent the glass from rattling in the door. White ABS plastic. 16 required for each car.

Year	Part No.	List
69-70	C9ZZ-6521496	\$3.95 ^{EA}

DOOR GLASS MOUNT AND TRACK KIT



Everything you need to install the much improved 1970 Bolt in Glass into a 1969 Mustang. Great upgrade over 1969 glue in versions. Requires using a 1970 window Regulator.

Year	Description	Part No.	List
69-70	Right Hand	DOZZ-6321410-MK	\$134.95 ^{KI}
69-70	Left Hand	DOZZ-6321411-MK	\$134.95 ^{KI}

REAR VERTICAL GLASS RUN REPAIR KIT

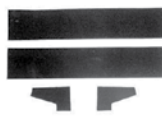

Original type style mohair/felt which covers run channel. Includes adhesive backing. Repairs both sides, Channel not

included.

Year	Part No.	List
64-66	C5ZZ-6521508-RK	\$22.95 ^{KI}

REAR VERTICAL GLASS RUN ASSEMBLY



64-66 versions have correct mohair/felt attached for smooth operation. 67-68 version pictured.

Year	Description	Part No.	List
64-66	RH	C5ZZ-6521508-A	\$54.95 ^{EA}
64-66	LH	C5ZZ-6521509-A	\$54.95 ^{EA}
67-68	RH	C7ZZ-65222A36-R	\$84.95 ^{EA}
67-68	LH	C7ZZ-65222A37-L	\$84.95 ^{EA}

TOP VENT WINDOW SEAL



Made from compression molded E.P.D.M. rubber with cadmium plated steel inserts molded inside.

Includes rivets. Sold in sets.

Year	Part No.	List
64-66	C5ZZ-6521774/5A	\$10.00 ^{SE}

WE PROUDLY FEATURE AUTHENTIC MUSTANG REPRODUCTIONS FROM SCOTT DRAKE!



VENT WINDOW SEAL



Our high quality Scott Drake reproduction vent seals offer your customers the finest molded rubber pieces available.

Year	Description	Part No.	List
64-66	RH and LH	C5ZZ-6521448/9B	\$34.95 ^{PR}
64-66	RH	C5ZZ-6521448-B	\$19.95 ^{EA}
64-66	LH	C5ZZ-6521449-B	\$19.95 ^{EA}
67-68	RH	C7ZZ-6521448-AR	\$23.95 ^{EA}
67-68	LH	C7ZZ-6521449-AR	\$23.95 ^{EA}

VENT WINDOW DIVISION BAR SEAL

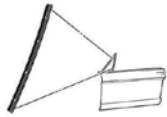

Offers a perfect fit with a steel insert molded into high quality E.P.D.M. rubber. Mounts on back side of vent window bar.

Now original type rivets included.

Year	Part No.	List
64-66	C5ZZ-6521450-A	\$8.00 ^{EA}

VENT WINDOW SEAL KIT



Convenient time saving kit offers you everything to complete vent seal installation. Kit features vents seals, top vent seals,

back edge vent seals, and all rivets. Check out our rivet tools to make the job easier.

Year	Part No.	List
64-66	KIT-RUB-5	\$62.95 ^{KI}
67-68	KIT-RUB-6	\$64.95 ^{KI}

VENT WINDOW TO DOOR SEAL



These high quality vent window seals are the first on the market to replace the original Ford part exactly. This is the small seal at the front of the door and next to the door weatherstrip.

Year	Part No.	List
67-68	C7ZZ-6522332/3	\$13.95 ^{PR}

VENT WINDOW FRAME TO DOOR SEAL

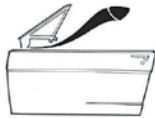

Seals between chrome vent frames and door on exterior side.

Year	Part No.	List
67-68	C60Z-6322280	\$4.95 ^{PR}

VENT WINDOW FRAME

& DOOR GLASS RUN ASSEMBLY



Complete vent and window assembly. Includes vent frame, vent glass, vent glass frame and pivot assembly, vent seals, and door glass run. 1964-66 version pictured.

Year	Description	Part No.	List
64-66	RH, clear	C5ZZ-65222404CK	\$349.95 ST
64-66	RH, tinted	C5ZZ-65222404TK	\$349.95 ST
64-66	LH, clear	C5ZZ-65222405CK	\$339.95 ST
64-66	LH, tinted	C5ZZ-65222405TK	\$349.95 ST
68*	RH, clear	C8ZZ-65222404CK	\$384.95 ST
68*	RH, tinted	C8ZZ-65222404TK	\$394.95 ST
68*	LH, clear	C8ZZ-65222405CK	\$384.95 ST
68*	LH, tinted	C8ZZ-65222405TK	\$394.95 ST

*68 versions will also fit 1967, but for 1968 only vent handle is concours.

VENT WINDOW FRAME



Die cast construction with good chrome plating.

Year	Description	Part No.	List
64-66	LH	C5ZZ-6522204-L	\$159.95 ^{EA}
64-66	RH	C5ZZ-6522204-R	\$159.95 ^{EA}
67-68	LH	C7ZZ-6522204-L	\$169.95 ^{EA}
67-68	RH	C7ZZ-6522204-R	\$169.95 ^{EA}

VENT WINDOW GLASS ASSEMBLY



Stainless steel vent window glass frame with pivot and glass. Will fit 1968, but comes with 1967 vent window handle attached.

Year	Description	Part No.	List
67	RH, clear	C7ZZ-6521608-CK	\$99.95 ^{EA}
67	RH, tinted	C7ZZ-6521608-TK	\$104.95 ^{EA}
67	LH, clear	C7ZZ-6521609-CK	\$99.95 ^{EA}
67	LH, tinted	C7ZZ-6521609-TK	\$104.95 ^{EA}

VENT WINDOW GLASS FRAME



Complete stainless steel vent window frame with pivots and vent handle. Glass not included.

Year	Description	Part No.	List
65-66	RH	C5ZZ-6521608-A	\$49.95 ^{EA}
65-66	LH	C5ZZ-6521609-A	\$49.95 ^{EA}
67	RH	C7ZZ-6521608-A	\$49.95 ^{EA}
67	LH	C7ZZ-6521609-A	\$49.95 ^{EA}

VENT WINDOW BRACKET



Bracket with shaft to tighten up loose handles.

Year	Description	Part No.	List
64-66	RH	C5ZZ-6521608-RK	\$13.95 ^{EA}
64-66	LH	C5ZZ-6521609-RK	\$13.95 ^{EA}

VENT WINDOW HANDLE



Our vent handles are cast from our own tooling with a great chrome finish. Our nylon tips will not scratch the vent frame. Sold as a

matched pair. Year several Ford models. Roll pins included.

Year	Part No.	List
64-66	C30Z-6222916/7A	\$19.95 ^{SE}
67	C60Z-6522916/7A	\$29.95 ^{PR}
68	C80Z-5422916/7B	\$29.95 ^{PR}

DOOR WEATHER STRIPPING

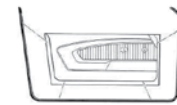

Made from the finest E.P.D.M. rubber, these sponge extrusions have transfer molded ends like the originals. These are

not glued and feature the correct cross section and size for proper sealing. Includes original looking mounting fasteners.

Year	Desc	Part No.	List
64-66	Door	C5ZZ-6520530/1A	\$19.95 ^{PR}
67-68	Door	C7ZZ-6520530/1A	\$24.95 ^{PR}
69-70	Door	C9ZZ-6520530/1A	\$39.95 ^{PR}
71-73	Door	D1ZZ-6520530/1A	\$59.95 ^{PR}

DOOR BOTTOM WEATHER STRIPPING

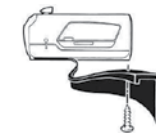

This seal cuts down wind and road noise. attaching hardware included.

Year	Description	Part No.	List
69-70	Door Bottom	C9ZZ-6520272-A	\$13.95 ^{PR}

FRONT DOOR TO WINDOW SEAL



Made from a high quality rubber. These feature a steel insert molded inside. Year on rear door edge. See "Rubber" section for

Quarter Window to Body Seals.

Year	Description	Part No.	List
64-66	With screws	C5ZZ-6520588/9K	\$10.95 ^{SET}
64-66	Without screws	C5ZZ-6520588/9B	\$10.95 ^{PR}
68		C80Z-5422916/7B	\$29.95 ^{PR}



67-68
Late 67
C7ZZ-6520588/9B

List
\$9 ⁹⁵ PR



67
Early 67
C7ZZ-6520588/9A

List
\$18 ⁹⁵ PR



69-70
C9ZZ-6520264/5A

List
\$9 ⁹⁵ PR



71-73
D1ZZ-6520264/5

List
\$19 ⁹⁵ PR

DOOR AND QUARTER SEAL SCREW



Used to secure the seals both on the quarter panel and on the rear of the door window seal. Black oxide finish.

Year	Description	Part No.	List
65-68	Set of 22	52718-S	\$2 ⁹⁵ KI
64-73	Bulk, sold in bags of 100	52718-SMK	\$15 ⁰⁰ EA

CONCOURS WINDOW CHANNEL STRIPS



We proudly carry the full line of Re-Pops window channel strips. Rest assured that these are the highest quality on the market.

These window channel strips have the correct bends and staples. They also come with easy to understand instructions and a drill bit for installation. Made in the USA.

Year	Description	Part No.	List
65-66	Fastback	C5ZZ-6321458/9S	\$64 ⁹⁵ SE
65-66	Coupe and convertible	C5ZZ-6521458/9S	\$80 ⁹⁵ SE
67-68	Fastback	C7ZZ-6321458/9S	\$56 ⁹⁵ SE
67-68	Coupe	C7ZZ-6521458/9S	\$72 ⁹⁵ SE
67-68	Convertible	C7ZZ-7621458/9S	\$72 ⁹⁵ SE
69-70	Fastback	C9ZZ-6321458/9S	\$63 ⁹⁵ SE
69-70	Coupe	C9ZZ-6521458/9S	\$89 ⁹⁵ SE
69-70	Convertible	C9ZZ-7621458/9S	\$89 ⁹⁵ SE
71-73	Fastback	D1ZZ-6321458/9S	\$86 ⁹⁵ SE
71-73	Coupe	D1ZZ-6521458/9S	\$86 ⁹⁵ SE
71-73	Convertible	D1ZZ-7621458/9S	\$86 ⁹⁵ SE

QUALITY IMPORT WINDOW CHANNEL STRIPS



These are a great alternative for those on a budget compared to our premium USA version.

More like originals than our economy versions, listed below.

Year	Description	Part No.	List
65-66	Fastback	C5ZZ-6321458/9R	\$52 ⁹⁵ SE

ECONOMY WINDOW CHANNEL STRIPS



These feature narrow outer strips rather than concours wide outer strips. Good alternative for daily drivers.

Year	Description	Part No.	List
65-66	Fastback, economy	C5ZZ-6321458/9E	\$42 ⁹⁵ SE
64-66	Coupe & convertible, economy	C5ZZ-6521458/9E	\$62 ⁹⁵ SE

WEATHER STRIP ADHESIVE



Super strong weatherstrip adhesive for installing door and trunk seals. From 3M.

Supplied in five ounce tubes. Cannot be shipped by air.

Year	Description	Part No.	List
64-73	Yellow, not for EPDM rubber	3M-8001	\$10 ⁹⁵ EA
64-73	Black, not for EPDM rubber	3M-8008	\$11 ⁹⁵ EA
64-73	Black, for EPDM rubber	3M-8011	\$11 ⁹⁵ EA

WINDOW SEALER



Used to water-proof windshield and rear window. Silicone type sealer is best suited for glue in windshields. Non-hardening version also works well on retaining watershields.

Year	Description	Part No.	List
64-73	Non-hardening	CRL-7708	\$9 ⁹⁵ EA

DOOR GLASS ASSEMBLY



This door glass includes the frame, glass run and mounting bracket. Available in clear glass or factory green tint. For replacement glass only, see windows section.

Part No.	Year	Description	List
C7ZZ-6321410-KL	67-68	Fastback, LH, clear	\$279 ⁹⁵ KT
C7ZZ-6321410-KR	67-68	Fastback, RH, clear	\$279 ⁹⁵ KT
C7ZZ-6521410-KL	67-68	Coupe, LH, clear	\$274 ⁹⁵ KT
C7ZZ-6521410-KR	67-68	Coupe, RH, clear	\$274 ⁹⁵ KT
C7ZZ-7621410-KL	67-68	Convertible, LH, clear	\$279 ⁹⁵ KT
C7ZZ-7621410-KR	67-68	Convertible, RH, clear	\$279 ⁹⁵ KT
C7ZZ-6321410-TL	67-68	Fastback, LH, tinted	\$279 ⁹⁵ KT
C7ZZ-6321410-TR	67-68	Fastback, RH, tinted	\$279 ⁹⁵ KT
C7ZZ-6521410-TL	67-68	Coupe, LH, tinted	\$274 ⁹⁵ KT
C7ZZ-6521410-TR	67-68	Coupe, RH, tinted	\$274 ⁹⁵ KT
C7ZZ-7621410-TL	67-68	Convertible, LH, tinted	\$279 ⁹⁵ KT
C7ZZ-7621410-TR	67-68	Convertible, RH, tinted	\$279 ⁹⁵ KT

DOOR GLASS BUMPER



Rubber bumper that installs inside the bottom of the door that stops the travel of door glass. One required per door, snaps into place.

Year	Description	Part No.	List
64-70	Lower	C5ZZ-6521762	\$4 ⁰⁰ EA

WINDOW GROMMET



Protects door glass when attaching window channel.

Year	Part No.	List
69-70	C9ZZ-6523258-B	\$1 ⁷⁵ EA

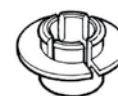

Injected molded plastic and wear resistant.

Year	Part No.	List
69-70	C9ZZ-6323266	\$2 ⁵⁰ EA

WE PROUDLY FEATURE AUTHENTIC MUSTANG REPRODUCTIONS FROM SCOTT DRAKE!



DOOR ACCESS PLUG



Steel stamped with nickel plating. Original should be painted body color.

Year	Part No.	List
64-66	CSZZ-6522286	\$2 ⁹⁵ EA

DOOR TAG PLATE



Exact copies of the original data plate tags. Reverse stamped, like originals, to match your cars

specifications. Attaches to driver's door inside jam. Specify VIN, body, color, trim, date of manufacture, DSO, axle and transmission codes. Authentic mounting rivets are also included. Must fax or email your VIN info. Allow 3 weeks to receive.

Year	Description	Part No.	List
64-69	W/ rivets	DT-1	\$49 ⁹⁵ EA
70-73	Paper tag with cover	DT-3	\$49 ⁹⁵ EA

DOOR TAG PLATE RIVETS



Special aluminum attaching rivets. Authentic look.

Year	Part No.	List
64-69	CSZZ-6223000-A	\$6 ⁹⁵ PR

ELECTRICAL

REFERENCE BOOKS

WIRING DIAGRAM MANUAL



Covers a multitude of electrical pictorial diagrams, color codes are listed, plus easy to follow schematics.



Year	Part No.	List
64	MP-312	\$6 ⁹⁵ EA
65	MP-1	\$6 ⁹⁵ EA
66	MP-2	\$6 ⁹⁵ EA
67	MP-3	\$6 ⁹⁵ EA
68	MP-4	\$6 ⁹⁵ EA
69	MP-5	\$6 ⁹⁵ EA
70	MP-6	\$6 ⁹⁵ EA
71	MP-7	\$6 ⁹⁵ EA
72	MP-8	\$6 ⁹⁵ EA
73	MP-9	\$6 ⁹⁵ EA

LARGE FORMAT WIRING DIAGRAM MANUAL



Covers a multitude of electrical pictorial diagrams, color codes are listed, plus easy to follow schematics. Our large format features larger diagrams that

are easier to read.



Year	Part No.	List
64	MP-311-P	\$12 ⁹⁵ EA
65	MP-1-P	\$12 ⁹⁵ EA
66	MP-2-P	\$12 ⁹⁵ EA
67	MP-3-P	\$12 ⁹⁵ EA
68	MP-4-P	\$12 ⁹⁵ EA
69	MP-5-P	\$12 ⁹⁵ EA
70	MP-6-P	\$12 ⁹⁵ EA
71	MP-7-P	\$12 ⁹⁵ EA
72	MP-8-P	\$12 ⁹⁵ EA
73	MP-9-P	\$12 ⁹⁵ EA

FOG LAMPS

G.T. FOG LIGHT BULB



Restore your mustang back to showroom condition by replacing your cracked or damaged fog lamps with a new glass set from Scott Drake. Our 4 1/2" 1965-68 Mustang Fog Lamps have a unique styled GT logo on the lens center. These high quality fog lamps have the brightest illumination available on the market for improved visibility. Featuring authentic USA, F52, and FOG markings on the lens, just like the original. The amber lenses are manufactured with strict quality control consistency for the greatest visibility under foggy road conditions. This is a direct replacement and it is available in clear or amber.

Year	Description	Part No.	List
65-68	Clear	FDU-15220-GT	\$11 ⁹⁵ EA

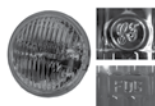

Year	Description	Part No.	List
64-69	Amber	FDU-15220-GTAM	\$13 ⁹⁵ EA

CONCOURS G.E. FOG LIGHT BULB



Features original GE logo and "fog" script on lens.

Year	Description	Part No.	List
65-68	Clear	FDU-15220-A	\$18 ⁹⁵ EA

FOG LIGHT HOUSING ASSEMBLY

Our Fog Light Housing Assemblies are the best on the market. Assemblies include triple chrome-plated rims, silver painted housings on back, an exact copy of wiring harness, cup mounting washer, and serrated flange nut. Also features the correct wire exit and drain hole. Bulb not included. See "Grille" section for fog light bars.



65-67: Concours correct
CSRZ-15200-A

List
\$37 ⁹⁵ EA



68: w/out correct wire pigtail
C8ZZ-15200-A

List
\$37 ⁹⁵ EA



68: Blue plug, concours correct
C8ZZ-15200-AC

List
\$39 ⁹⁵ EA



68: w/out crossbar,
w/out correct wire pigtail
C8ZZ-15200-SPEC

List
\$42 ⁹⁵ EA

TRI-BAR FOG LIGHT HOUSING ASSEMBLY



These 4" fog lamps feature our quality fog light housings, beautiful chrome bezels, and include an internal chrome, tri-bar design. The perfect match to our larger, tri-bar headlights.

Year	Part No.	List
64-67	CSZZ-15200-TB	\$104 ⁹⁵ EA

FOG LIGHT HOUSING RIM



For customers who wish to restore their own housings, these perfect reproductions feature triple chrome plating and an exact fit.

Year	Description	Part No.	List
65-68	W/bar	C5ZZ-15214-A	\$19. ⁹⁵ EA
65-68	W/out bar	C5ZZ-15214-SPEC	\$39. ⁹⁵ PR

MACH 1 SPORT LIGHTS

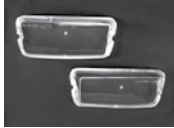

1970: Mach 1 Sport Light Lens w/ Ford Logo
C9WY-13208/9

List
\$39.⁹⁵ PR



1970: Mach 1 Sport Light Bezel, Unpainted
D0ZZ-13210

List
\$67.⁹⁵ PR



1971-72: Mach 1 Sports Light Housing, RH or LH (bulb not included)
D1ZZ-13200-B

List
\$37.⁹⁵ EA



FOG LIGHT WIRING CIRCUIT BREAKER



Mounts under dash, controls voltage for wire protection. Includes primary wire which connects to Headlamp Switch Plug
Instructions included.



Year	Part No.	List
65-68	C5ZZ-15223-CB	\$10. ⁹⁵ KI
68	C8ZZ-14448-F	\$12. ⁹⁵ EA

FOG LIGHT WIRING CONVERSION KIT



Everything you need to hook up your fog lights. Kits feature correct colored connectors and include circuit breaker. (Fog light switch sold separately).

Year	Description	Part No.	List
64-65	Instrument warning light cars	C5ZZ-15223-FUD	\$53. ⁹⁵ KI
66-67	All non GT cars	C6ZZ-15223-FUD	\$49. ⁹⁵ KI
68		C8ZZ-15223-FUD	\$53. ⁹⁵ EA

FOG LIGHT WIRING FEED



Hot wire from fog light under-dash harness to fog light housing pigtail. Connects left and right fog light. 1965 GT cars originally had this feed wrapped into the headlight harness.

Year	Description	Part No.	List
64-65	Warning light cars	C5ZZ-15223-FF	\$22. ⁹⁵ EA
66-67	GT and non GT cars	C6ZZ-15223-FF	\$20. ⁹⁵ EA
68	W/ correct blue plugs	C8ZZ-15223-UHH	\$29. ⁹⁵ EA

FOG LIGHT WIRING GROUND



All black wire which plugs into fog lamp pigtail and grounds to radiator support.

Year	Part No.	List
65-68	C5ZZ-15223-GR	\$6. ⁹⁵ PR

FOG LIGHT WIRING PIGTAIL



Pigtail wires which connect to bulb and run through housings and plug into fog light feed. Not necessary if purchasing fog lamp housings as pigtails are included.

Year	Description	Part No.	List
64-67	Correct connectors	C5ZZ-15223-FGPT	\$11. ⁹⁵ EA
68	Correct blue plug	C8ZZ-15223-FGPT	\$13. ⁹⁵ EA

FOG LIGHT WIRING UNDER-DASH HARNESS



Correct color coded wiring for fog lights.

Year	Description	Part No.	List
65		C5ZZ-15223-UDH	\$30. ⁹⁵ EA
66		C6ZZ-15223-UDH	\$25. ⁹⁵ EA
67		C7ZZ-15223-UDH	\$27. ⁹⁵ EA
68		C8ZZ-15223-UDH	\$27. ⁹⁵ EA
69	Shelby	S9MS-15223-A	\$189. ⁹⁵ EA

FOG LIGHT SWITCH



Nice reproduction of original part, which duplicates the factory wiring pigtail, bezel and knob

Year	Description	Part No.	List
65	Factory plug for original 65 GT cars only	C5ZZ-15A214-A	\$29. ⁹⁵ EA
65-66	Complete w/ pigtail	C6ZZ-15A214-A	\$29. ⁹⁵ EA
67		C7ZZ-15A214-A	\$29. ⁹⁵ EA
68		C8ZZ-15A214-A	\$41. ⁹⁵ EA
70	Mach I Sportslamps	D0ZZ-13256	\$57. ⁹⁵ EA

HEADLIGHTS

HEADLIGHTS



We offer a variety of Aftermarket Headlamps: Choose from Stock Halogen Sealed Beams replacements. High Performance Tri-Bar version with 55W Clear or Blue Replaceable Bulbs. European High Performance Bulbs as well as Xenon Bulbs. We also carry FoMoCo Script Halogen Sealed Beam Bulbs as seen above.



Year	Description	Part No.	List
69	Starlite Halogen, Stock replacement	C9ZZ-13007-SL	\$45. ⁹⁵ EA
64-73	High performance, Tri bar	C5ZZ-13007-CLR	\$84. ⁹⁵ EA
64-73	High performance, Tri bar, blue	C5ZZ-13007-LBB	\$84. ⁹⁵ EA

FOMOCO HALOGEN HEADLIGHTS



Now available from Scott Drake, FoMoCo Halogen Headlights featuring authentic Ford markings and upgraded Halogen performance. This is a reproduction of a very desirable and rare version headlight used on Classic Mustangs. We took NOS new original Ford bulbs and duplicated them in appearance while improving them with Halogen lighting technology. Halogen headlights produce more than double the lighting power of original Tungsten bulbs. Perfect for drivers or trailer queens, a great safety improvement while maintaining an original look. Over the years Ford offered two FoMoCo script versions: one sand blasted etched logo, and the other a prominent reverse raised FoMoCo logo about 7/8" wide. We chose to reproduce the rare, highly sought reverse raised logo version, which is more attractive and easier to read. Approved by Ford as an official licensed product and packed in cartons of 12.



Year	Part No.	List
All Ford vehicles with 7" bulbs	C0DZ-13007-A	\$21. ⁹⁵ EA
Right Hand Drive 7" bulbs	C0DZ-13007-AUS	\$21. ⁹⁵ EA
1969 High/low 5 3/4"	B8AZ-13007-A	\$21. ⁹⁵ EA
1969 High 5 3/4"	B8AZ-13007-B	\$21. ⁹⁵ EA

WE PROUDLY FEATURE AUTHENTIC MUSTANG REPRODUCTIONS FROM SCOTT DRAKE!



HEADLIGHT ASSEMBLY HARDWARE KIT

A complete kit to mount a headlight assembly to the fender, everything you need. Sold each, it takes two per car.

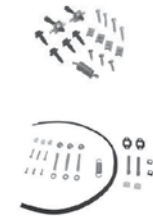

64-66
C5ZZ-13008-MK

List

\$14.00^{KI}

67-68
C7ZZ-13008-MK

List

\$18.95^{KI}

C8AZ-13118/9-MK
69: 1 side (2 kits required per vehicle)

List

\$9.95^{EA}

HEADLIGHT ADJUSTING KIT



Includes threaded adjusting stud and nylon insert. Nylon insert is slightly larger than O.E.M. and

requires minimal filing for proper fit into original retainer. Economy kit.

Year	Part No.	List
64-66	C3MY-13181/032K	\$2.50 ^{KI}

HEADLIGHT ADJUSTING NUT



New by Scott Drake, a 1964-66 Mustang Headlight Adjustment Nut with Screw. It features the correct metal, nylon nut and screw..

Year	Part No.	List
64-66	C3MY-13181-K	\$4.95 ^{EA}

HEADLIGHT ADJUSTERS



Part No.	Year	List
C9AZ-13032-A	69	\$7.50 ^{PR}

HEADLIGHT BUCKET



Headlight bucket, painted black, no hardware.

Year	Description	Part No.	List
64-66	RH or LH	C5ZZ-13008-A	\$12.95 ^{EA}
67-68	RH	C7ZZ-13008-A	\$15.95 ^{EA}
67-68	LH	C7ZZ-13008-B	\$15.95 ^{EA}
69	RH - Inner	C8AZ-13118-A	\$17.95 ^{EA}
69	LH - Inner	C8AZ-13119-A	\$17.95 ^{EA}
69	RH - Outer	C8AZ-13118-B	\$25.95 ^{EA}
69	LH - Outer	C8AZ-13119-B	\$25.95 ^{EA}
70	RH	DOZZ-13118-A	\$25.95 ^{EA}
70	LH	DOZZ-13119-A	\$25.95 ^{EA}

HEADLIGHT BUCKET ASSEMBLY



Reproduction headlight bucket assembly. Kit contains mounting hardware. See Website for individual photos of each kit.

Year	Description	Part No.	List
65-66	RH	C5ZZ-13008-CR	\$144.95 ^{KI}
65-66	LH	C5ZZ-13008-DR	\$144.95 ^{KI}
67-68	RH	C7ZZ-13008-CR	\$164.95 ^{EA}
67-68	LH	C7ZZ-13008-DR	\$164.95 ^{EA}
69	RH	C9ZZ-16018-R	\$329.95 ^{EA}
69	LH	C9ZZ-16019-L	\$329.95 ^{EA}
70	RH	DOZZ-16018-R	\$439.95 ^{EA}
70	LH	DOZZ-16019-L	\$439.95 ^{EA}

HEADLIGHT RETAINING RING

Headlight ring features, high-quality, stamped steel construction. Our new D3TZ-13015-A version Year without modification and features key hole mounting where many others do not.



D3TZ-13015-A
64-73: does not fit 69 Mustang

List

\$9.95^{EA}



C7AZ-13015-B
69

List

\$10.95^{EA}

HEADLIGHT DOOR

Die cast headlight door which Year on the headlight assembly. Primered.



C5ZZ-13064-B1965-66
C5ZZ-13064-B (RH)
C5ZZ-13064-A (LH)

List

\$32.95^{EA}



67-68: Primered
C7ZZ-13064-A

List

\$19.95^{EA}



67-68: Chrome (both sides w/ Chrome screws)
C7ZZ-13064-C

List

\$45.95ST



69: Outer, chrome
C9ZZ-13064-A

List

\$29.95^{EA}



69: Inner
C9ZZ-13064-B/C

List

\$49.95^{PR}



70
DOZZ-13064-A/B

List

\$49.95^{PR}

HEADLIGHT SWITCH COVER



Molded rubber cover which Year over headlight dimmer switch.

Year	Part No.	List
65-73	C5ZZ-13533	\$4.95 ^{EA}

HEADLIGHT DIMMER SWITCH



This quality after-market dimmer switch matches the original nicely. Imported. Note: Electrical parts are not returnable.

Year	Description	Part No.	List
64-73		COTZ-13A024-A	\$7.50 ^{EA}

SHOP WITH CONFIDENCE! WE OFFER SUPERIOR-QUALITY PARTS FOR ALL YOUR MUSTANG RESTORATION NEEDS.

BILLET DIMMER SWITCH



By Scott Drake is the beautifully machined and anodized billet Dimmer Switch Cover. Crafted with our exclusive tread pattern to match our fine line of billet pedal covers, this Switch cover will fit 1965-73 Mustangs as well as 1966-77 Broncos.

Year	Description	Part No.	List
65-73	Billet	C5Z-13533-BL	\$19.95 ^{EA}

HEADLIGHT SWITCH



Quality imported switches at affordable prices.

Part No.	Year	Description	List
C5Z-11654-C	64	Generator	\$64.95 ^{EA}
C5Z-11654-BR	65-68		\$19.95 ^{EA}
C9Z-11654-AR	69		\$26.95 ^{EA}
D0Z-11654-A	70		\$39.95 ^{EA}
D3Z-11654-A	71-72		\$19.95 ^{EA}

HEADLIGHT SWITCH BEZEL



New, chrome bezels really make a freshly painted dash pop. Beautiful reproductions.

Year	Description	Part No.	List
64-66		C4DZ-10852-B	\$8.25 ^{EA}
67-68		C7Z-10852-A	\$9.95 ^{EA}
69-70		C9Z-10852-L	\$18.95 ^{EA}

HEADLIGHT SWITCH KNOB



Knob is die-cast zinc, chrome plated with very good detail. Switch shaft is zinc plated to prevent rust or corrosion.

Part No.	Year	Description	List
C4Z-11661-A	64		\$10.95 ^{EA}
C5Z-11661-B	65-66		\$9.95 ^{EA}
C7Z-11661-A	67-68		\$12.95 ^{EA}
C9Z-11661-A	69-70		\$19.95 ^{EA}

HEADLIGHT SWITCH RETAINING NUT



Beautiful chrome retaining nut that holds headlight switch into the dash. These were previously difficult to find. Made from original factory prints.

Year	Part No.	List
65-66	C5Z-11650-A	\$14.95 ^{EA}
67-68	C7Z-11650-A	\$14.95 ^{EA}

HEADLIGHT WIRING GROMMET



Snaps into LH Fender Apron to prevent Headlight Harness from being damaged

Part No.	Year	List
C5Z-14603-H	65-66	\$2.50 ^{EA}

HEADLIGHT WIRING HARNESS EXTENSION



Concours correct. Attaches to headlight harness and connects to seal beam.

Year	Part No.	List
67-68	C7Z-13076-EXT	\$18.95 ^{EA}
69	C9Z-13076-EXT	\$21.95 ^{EA}
70	D0Z-13076-EXT	\$19.95 ^{EA}

SIDE MARKER REPAIR SOCKET



A replacement socket for the marker light.

Year	Part No.	List
69-73	D0DZ-15434	\$7.95 ^{EA}

HEADLIGHT WIRING HARNESS



Connects to firewall near master cylinder and runs along driver side inner fender apron and across radiator support. Connects headlights, (1967 - 70 do not include headlamp extension).

Year	Description	Part No.	List
64		C4Z-14290-ALL	\$72.50 ^{EA}
65	W/ gauges and fog lamps	C5Z-14290-WG	\$114.95 ^{EA}
65	W/ warning lamps	C5Z-14290-WL	\$99.95 ^{EA}
66	W/ gauges	C6Z-14290-ALL	\$99.95 ^{EA}
67	W/out tachometer, w/out GT	C7Z-14290-A	\$164.95 ^{EA}
67	W/out tachometer, w/ GT	C7Z-14290-B	\$189.95 ^{EA}
67	W/ tachometer, w/ out GT	C7Z-14290-C	\$219.95 ^{EA}
67	W/ tachometer, w/ GT	C7Z-14290-D	\$229.95 ^{EA}
68	W/out tachometer, w/out GT	C8Z-14290-A	\$189.95 ^{EA}
68	W/out tachometer, w/ GT	C8Z-14290-B	\$199.95 ^{EA}

Year	Description	Part No.	List
68	W/ tachometer, w/ out GT	C8Z-14290-C	\$204.95 ^{EA}
68	W/ tachometer, w/ GT	C8Z-14290-D	\$224.95 ^{EA}
69	W/out tachometer	C9Z-14290-A	\$264.95 ^{EA}
69	W/ tachometer	C9Z-14290-B	\$274.95 ^{EA}
70	W/out sport lights	D0Z-14290-A	\$274.95 ^{EA}
70	W/ sport lights	D0Z-14290-B	\$294.95 ^{EA}
70	Mach 1, w/ sports lights after 10-15-69	D0ZZ-14290-L	\$294.95 ^{EA}

HEADLIGHT "ON" WARNING BUZZER



The Scott Drake headlight "ON" warning buzzer is designed to activate when either the parking lights or head lights are left on after the ignition is turned off. This is a easy to install kit using quick splice connectors. No permanent alterations to the car's wiring are required. Includes instructions for 1965-67 Mustang's, however our warning buzzer kit can also be adapted to fit other makes and models of cars.

Year	Part No.	List
65-70	C6AZ-14931-AR	\$24.95 ^{SE}

GRILLE CORRAL LED LIGHT KIT



Add some flair to the front of your Mustang with a Grille Corral that lights up. Our kits work with your existing 1964-67 Corral and Running Horse emblem. Kits include back reflector panel, waterproof LED modules, and electrical connectors. Simple installation with flexible wiring options. Grille Corral and Horse available separately from Scott Drake.

Year	Part No.	List
64-66	C7Z-8213-LED	\$39.95 ^{KI}
67	C7Z-8213-LED	\$39.95 ^{KI}

WE PROUDLY FEATURE AUTHENTIC MUSTANG REPRODUCTIONS FROM SCOTT DRAKE!



Authorized Dealer

57

Electrical

HOOD TURN SIGNALS

COWL-HOOD GROUNDING STRAP



This piece is an exact reproduction. Brass contact strap with correct mounting screw.

Year	Part No.	List
67-68	CSAA-18870-A	\$5.95 ^{EA}

HOOD TURN SIGNAL HARNESS



Connects both L.H. and R.H. turn signal lamps, plugs into firewall harness. Includes sockets.

Year	Part No.	List
67-68	C7ZZ-13A357-TSH	\$24.95 ^{EA}
69-70	C9ZZ-13A357-TSH	\$37.50 ^{EA}

HOOD TURN SIGNAL ASSEMBLY

A nice reproduction. Includes lens seal.



C7ZZ-13A355-B
67-68

List
\$36.95^{EA}



C9ZZ-13A355-A
69-70

List
\$52.95^{EA}

SEQUENTIAL HOOD TURN SIGNAL LIGHT ASSEMBLY



These upgraded Sequential Turn-Signal Hood Lights now feature SMD LED's. Exclusively designed

for the turn signals in the back of the hood scoop. White led lamps produce highly visible light, even in daylight. Features "plug in and go" simplicity. Works with or without our sequential tail light kit.

Year	Part No.	List
67-68	C7ZZ-SHL	\$49.95 ^{SE}
69-70	C9ZZ-SHL	\$49.95 ^{SE}

INTERIOR ELECTRICAL

CLOCK FEED WIRE



Correct feed wire for the clock.

Part No.	Year	List
C9ZZ-15A006-CL	69-70	\$30.95 ^{EA}

CONSOLE HARNESS FEED



This harness supplies power to the console. Comes from under dash harness and runs underneath carpet, exits at carpet shifter hole location.

Year	Description	Part No.	List
64-66	Dash to console	CSZZ-13B712-A	\$28.95 ^{EA}
69	Dash to console	C9ZZ-13B712-A	\$34.95 ^{EA}
68	Shelby, dash to console	S8MS-13B712-A	\$34.95 ^{EA}

CONSOLE INTERIOR HARNESS



This harness plugs into console harness feed. Operates rear courtesy lights and front storage compartment on non AC cars.

Year	Description	Part No.	List
64-66	W/out AC	CSZZ-13B711-LG	\$19.95 ^{EA}
64-66	W/ AC	CSZZ-13B711-SM	\$15.95 ^{EA}

CONSOLE LAMP LENS



Year on the rear of the console. Original white plastic color.

Year	Part No.	List
64-66	CSZZ-13734-A	\$5.95 ^{EA}
67-68	C7ZZ-13783-A	\$6.95 ^{EA}

CONSOLE REAR LAMP ASSEMBLY



Good quality reproduction part, features white plastic lens and pressure die cast body with excellent chrome on the bezel.

Year	Part No.	List
64-66	CSZZ-13707-A	\$49.95 ^{EA}
67-68	C7ZZ-13707-A	\$49.95 ^{EA}

CONVERTIBLE TOP HARNESS



This is the main harness for the power convertible top. Made in the USA.

Year	Description	Part No.	List
64-68	Concours for 64-66	CSZZ-7615A668	\$79.95 ^{EA}
67-68	Concours for 67-68	C7ZZ-7615A668	\$79.95 ^{EA}

DOOR COURTESY LIGHT HARNESS



For deluxe interior cars with door lights and/ or door speakers. 64-68 harness includes an extra red wire that can be used for LED mirror, remote door locks. If not needed it easily snips out of harness. See "Door" section for Door Lights.

Year	Description	Part No.	List
64-66	W/out speakers	CSZZ-13A769-A	\$28.95 ^{EA}
66	W/ speakers	C6ZZ-13A769-A	\$39.95 ^{EA}
67-68	W/ speakers	C7ZZ-13A769-A	\$38.95 ^{EA}
69-70	W/ speakers	C9ZZ-13A769-A	\$59.95 ^{EA}

DOOR SPEAKER CROSSOVER HARNESS



Connects door harnesses to radio.

Year	Part No.	List
66-70	C6ZZ-13A770-A	\$28.95 ^{EA}

DOME LIGHT ASSEMBLY



We made a bright chrome base with a brighter than original bulb to really improve lighting inside the car. We include instructions on how to easily add this dome lamp to earlier Mustangs that didn't have this feature. Our dome light assembly can even be mounted up under the back deck to make a great trunk light. Our reproduction dome lens and chrome bezel as well as the mounting hardware and electrical connectors are included to make this a quick and simple project.

Part No.	Year	List
COAF-13A719-B	65-70	\$34.95 ^{KI}

DOME LIGHT HOUSING

Housing is chromed plastic.



67-70
COAF-13788-A

List
\$7.50^{EA}



71Late-73: Includes bulb
D6UZ-13788-A

List
\$24.⁹⁵EA

DOME LIGHT LENS

High quality injection molded parts, exactly like the originals. Lens is milk white.



67-70
COAF-13783-C

List
\$4.⁹⁵EA



71-73
D1AZ-13783-B

List
\$10.⁹⁵EA

LED DOME LIGHT ASSEMBLY

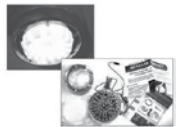

Kit comes complete with housing, hardware, and modern, smart LED module! This dome light is 5x brighter and automatically dims after 10 minutes, and turns off after 15 minutes. Lifetime warranty!

Year	Part No.	List
64-70	SD-DOME-LED-WH	\$84. ⁹⁵ EA

FASTBACK QUARTER PANEL LIGHT



These interior quarter lights are exact copies of the originals. Features include our high quality

chrome finish, correct connector and the flat index to orient the light in the correct position.

Year	Description	Part No.	List
65-68	Fastback	C4SZ-13776-B	\$39. ⁹⁵ EA
69-70	Fastback	DOAZ-13776-A	\$39. ⁹⁵ EA

FASTBACK QUARTER PANEL LIGHT LENS



Injection molded white plastic

Part No.	Year	List
C1SZ-13783-B	65-69	\$6. ⁹⁵ PR

SHIFT INDICATOR LIGHT



A nice reproduction. Features a bright zinc finish for long life. Ford type connectors for quick

installation.

Year	Description	Part No.	List
65-66	All	C5ZZ-15A808-A	\$52. ⁹⁵ EA
67-68	W/out console	C7ZZ-15A808-A	\$52. ⁹⁵ EA
67-68	W/ console	C7ZZ-15A808-B	\$54. ⁹⁵ EA

OVERHEAD CONSOLE ASSEMBLY



A beautiful reproduction of a rare option. The console base is made of vinyl and urethane with exact details. We have installed our maplight switch and light housing with our beautiful chrome bezels. Includes wiring harness and mounting screws. Mounting brackets available separately, please refer to the "Interior" section.

Year	Description	Part No.	List
67	Fastback, black	C7ZZ-63519A58BK	\$399. ⁹⁵ EA
67	Fastback, blue	C7ZZ-63519A58BL	\$399. ⁹⁵ EA
67	Fastback, ivy gold	C7ZZ-63519A58IG	\$399. ⁹⁵ EA
67	Fastback, parchment	C7ZZ-63519A58PR	\$399. ⁹⁵ EA
67	Fastback, red	C7ZZ-63519A58RD	\$399. ⁹⁵ EA
67	Coupe, black	C7ZZ-65519A58BK	\$399. ⁹⁵ EA
67	Coupe, blue	C7ZZ-65519A58BL	\$399. ⁹⁵ EA
67	Coupe, ivy gold	C7ZZ-65519A58IG	\$399. ⁹⁵ EA
67	Coupe, parchment	C7ZZ-65519A58PR	\$399. ⁹⁵ EA
67	Coupe, red	C7ZZ-65519A58RD	\$399. ⁹⁵ EA

OVERHEAD MAP LIGHT SWITCH

Scott Drake has assembled a set of modern switches into his reproduction map light housing to make a easy replacement of old switches. Works as good as it looks.



67-68: Buttons only
C7ZZ-13764-B

List
\$38.⁹⁵SE



67-68: Switches only
C7ZZ-13764-S

List
\$22.⁹⁵PR



67-68: Switch and buttons
C7ZZ-13764-KIT

List
\$59.⁹⁵EA

FUSE BOX REPAIR KIT



New clips to replace loose or corroded fuse holders. Contains eight clips.

Year	Part No.	List
64-68	FUSE CLIPS	\$39. ⁹⁵ KI

INSTRUMENT CLUSTER LOOM



Feature correct color codes.

Year	Description	Part No.	List
67	W/ tachometer	C7ZZ-10B942TACH	\$114. ⁹⁵ EA
67	No tachometer	C7ZZ-14401-ICF	\$109. ⁹⁵ EA
68	W/ tachometer	C8ZZ-10B942TACH	\$119. ⁹⁵ EA
68	No tachometer	C8ZZ-14401-ICF	\$114. ⁹⁵ EA

PRINTED INSTRUMENT PANEL CIRCUIT



Great product, this is a complete printed circuit to eliminate those dash electrical problems.

Year	Description	Part No.	List
69-70	W/out tachometer	C9ZZ-10K843-A	\$49. ⁹⁵ EA
69-70	W/tachometer	C9ZZ-10K843-T	\$79. ⁹⁵ EA

INSTRUMENT BULB SOCKET



This plastic and metal socket takes a #194 bulb and twists into backside of instrument housing.

Year	Description	Part No.	List
69-70	Bulb Socket	C80Z-13711-B	\$3. ⁵⁰ EA

WE PROUDLY FEATURE AUTHENTIC MUSTANG REPRODUCTIONS FROM SCOTT DRAKE!



INSTRUMENT GAUGE INSULATOR



69-70 cars requires 4 insulators and 71-73 cars require 1 insulator.

Year	Description	Part No.	List
69-73	Gauge Insulators	C9ZZ-10914	\$6 ²⁵ EA

INSTRUMENT VOLTAGE REGULATOR



From Scott Drake, these Instrument Voltage Regulators feature an improved design to be more reliable and accurate in varying environments

(heat, humidity, etc...). Features solid state electronic circuitry and variable control. Preset to factory specifications but adjustable to fine-tune your gauges.

Year	Part No.	List
64-66	B9MZ-10804-EADJ	\$39 ⁹⁵ EA
67-68	C6DZ-10804-EADJ	\$39 ⁹⁵ EA
69-73	C9AZ-10804-EADJ	\$39 ⁹⁵ EA

INSTRUMENT PANEL LED LIGHTS



Finally see your gauges at night with cool-running, lifetime LED's. 4x brighter than old incandescent lights! Each kit is warranted for the life

of your car, and includes gauge illumination lights (blue), turn signal indicator lights (white), and high-beam light (white/red). These kits use your existing gauges -- you just replace the bulbs! Lifetime warranty!

Year	Description	Part No.	List
64-66	Long Speedometer	SD-6456-GA-BL	\$25 ⁹⁵ EA
65-66	5-Gauge Cluster	SD-66-GA-BL	\$30 ⁹⁵ EA
67-68		SD-6768-GA-BL	\$30 ⁹⁵ EA
69-70		SD-6970-GA-BL	\$35 ⁹⁵ EA
71-73		SD-7173-GA-BL	\$35 ⁹⁵ EA
64-68	White 1895, set of 4	SD-1895	\$16 ⁹⁵ SE
64-68	Blue 1895, set of 4	SD-1895-BL	\$16 ⁹⁵ SE

INTERIOR LED LIGHTS



Convert your Mustang's interior lights to cooler running, brighter LED's. Many ordinary LED's don't work with classic Mustang

lighting circuits, but these are specifically designed to work with your classic Mustang! Lifetime warranty! Note: Does not include instrument panel bulbs.

Year	Description	Part No.	List
64-66	Standard Interior	SD-6466-INT-WH	\$39 ⁹⁵ EA
64-66	Pony Interior	SD-6466-INT-WHD	\$39 ⁹⁵ EA
67-68		SD-6768-INT-WH	\$39 ⁹⁵ EA

UNDER-DASH HARNESS



Includes fuse block, all molded ends and correct color codes. Note: 1965-66 harnesses do not include Wiper Motor Loom. Refer

to Wiper Motor Looms below.

Part No.	Year	Description	List
C4ZZ-14401-1SW	64	One speed wiper motor	\$599 ⁹⁵ EA
C4ZZ-14401-2SW	64	Two speed wipers	\$599 ⁹⁵ EA
C5ZZ-14401-WL-2	65	Two speed heater	\$449 ⁹⁵ EA
C5ZZ-14401-WL-3	65	Three speed heater	\$464 ⁹⁵ EA
C5ZZ-14401-WG	65	GT or pony interior	\$464 ⁹⁵ EA
C6ZZ-14401-ALL	66	All	\$464 ⁹⁵ EA
C7ZZ-14401-STD	67	Standard	\$599 ⁹⁵ EA
C7ZZ-14401-STDT	67	W/ tachometer	\$624 ⁹⁵ EA
C7ZZ-14401-GT	67	GT	\$619 ⁹⁵ EA
C7ZZ-14401-GT-T	67	GT w/ tachometer	\$649 ⁹⁵ EA
C8ZZ-14401-STD	68	Standard	\$659 ⁹⁵ EA
C8ZZ-14401-STDT	68	W/ tachometer	\$689 ⁹⁵ EA
C8ZZ-14401-STDF	68	W/ foglamp	\$679 ⁹⁵ EA
C8ZZ-14401-GT-T	68	GT w/ tachometer	\$699 ⁹⁵ EA
C9ZZ-14401-TACH	69	W/ tachometer	\$849 ⁹⁵ EA

AIR CONDITIONER UNDER-DASH HARNESS



Plugs into main A/C unit under dash, connects into back of ignition switch then, runs through firewall to

compressor switch.

Year	Part No.	List
64-66	C5ZZ-19800-ACF	\$27 ⁹⁵ EA
67	C7ZZ-19800-ACF	\$39 ⁹⁵ EA

CONTROL PANEL BEZEL AND LENSES



These control panel warning bezels

and red lenses replace factory units that are damaged or missing..

Year	Part No.	List
65-66	C7ZZ-10C876-KIT	\$44 ⁹⁵ SE

AIR CONDITIONER UNDER-DASH HARNESS



Plugs into main A/C unit under dash, connects into back of ignition switch then, runs through firewall to

compressor switch.

Year	Part No.	List
64-66	C5ZZ-19800-ACF	\$27 ⁹⁵ EA
67	C7ZZ-19800-ACF	\$39 ⁹⁵ EA

SEAT BELT UNDER-DASH REMINDER LIGHT

These lights look exactly like the originals, but feature a state-of-the-art LED light that will not melt the lens like the originals did. The LED light is rated at 100,000 hours & will last for years. This kit comes complete with a timer switch that will turn the light off after a short period of time.



65-66: Stick on
C60Z-10C876-A1

List
\$59 ⁹⁵ KI



67-68: w/ bracket
C7ZZ-10C876-B

List
\$59 ⁹⁵ KI

PARKING BRAKE UNDER-DASH WARNING LIGHT

These lights look exactly like the originals, but feature a state-of-the-art LED light that will not melt the lens like the originals did. The LED light is rated at 100,000 hours & will last for years. This kit comes complete with a switch and bracket assembly to install on the parking brake unit.



64-66: Stick on
C4DZ-15A852-A1

List
\$54 ⁹⁵ KI



67-68: w/ bracket
C7ZZ-15A852-A

List
\$54 ⁹⁵ KI

INTERIOR SWITCHES

COURTESY LIGHT SWITCH



Chrome

Available in two finishes! A white finish that is an exact reproduction of the original Ford part, or a new chrome finish. All our

68-70 switches feature the "Autolite" logo. Note: Our 68-70 versions are the 2 pin type. Many 1970-73 cars used 3 pin type switches for optional door ajar feature

Year	Description	Part No.	List
64-67	White, bulk	C3AZ-13713-A	\$5 ⁹⁵ EA
64-67	White	C3AZ-13713-AK	\$11 ⁹⁵ PR
64-67	Chrome	C3AZ-13713-ACK	\$13 ⁹⁵ PR
68-70	White w/ Autolite logo, bulk	C8AZ-13713-C	\$6 ⁹⁵ EA
68-70	White w/ Autolite logo	C8AZ-13713-CK	\$13 ⁹⁵ PR
68-70	Chrome w/ Autolite logo	C8AZ-13713-CCK	\$15 ⁹⁵ PR

SHOP WITH CONFIDENCE! WE OFFER SUPERIOR-QUALITY PARTS FOR ALL YOUR MUSTANG RESTORATION NEEDS.

COURTESY LIGHT SWITCH SOCKET



The original plastic sockets are very brittle & almost always breaks when installing a new door jamb switch. Does not fit

cars with door ajar option. Simply install by carefully breaking the old brittle plastic socket apart with pliers, remove, and plug wire leads into the new socket.

Year	Part No.	List
68-73	C8AZ-14489-K	\$4.95 EA

EMERGENCY FLASHER SWITCH



Switch and bracket for late 1966 Mustangs. Version without pigtail can also be spliced into early 1966 Mustangs. Early version

includes complete harness.

Year	Description	Part No.	List
66	W/out pigtail, for late 1966	C6AZ-13350	\$45.95 EA
66	With harness, for early 1966	C6AZ-13350-E	\$104.95 EA

TURN SIGNAL FLASHER

High quality replacement parts, may not appear original. Also used for emergency flashers.



65-70: Original style
C5AZ-13350-B

List

\$6.95 EA



65-70: Electronic Variable Flasher, for use w/ our sequential tail lights
STL-EVF-13350

List

\$14.95 EA

HORN SWITCH



Year deluxe or standard 2 spoke wheel.

Year	Part No.	List
70-73	D2AZ-13875	\$98.95 EA

RIM BLOW HORN SWITCH



The switch that goes inside the rim of the steering wheel to actuate the horn.

Year	Part No.	List
69	C9AZ-13A875-C	\$134.95 EA
70-73	D1AZ-13A875-A	\$119.95 EA

RIM BLOW HORN SWITCH GAP COVER



For the Rim Blow Steering Wheel only.

Year	Part No.	List
70-73	D1AZ-13875-CAP	\$13.95 EA

IGNITION SWITCH



Switches do not include bezels.

Year	Part No.	List
64-66	C3UZ-11572-A	\$14.95 EA
67	C5AZ-11572-B	\$18.95 EA
68-69	C8AZ-11572-A	\$15.95 EA
71-72	D1AZ-11572-BR	\$54.95 EA

IGNITION SWITCH PIGTAIL



Correct As Original. Repair harness that requires splicing.

Year	Part No.	List
64-66	C3UZ-11572-RPT	\$34.95 EA

IGNITION SWITCH PIGTAIL



Scott Drakes 1968-69 Mustang Ignition Switch Repair is a plug-in pig tail harness that promises to make repairing your Ignition Harness at the back of the switch, both easy and affordable. In keeping with the high standards that made Scott Drake the industry leader, all of the wires in the harness are correct color coded wires. Repairs both Factory Tach and Non-Tach Harness. Includes full length resistor wire. Depending on application all wires may not be used.

Year	Part No.	List
68-69	C9AZ-14313-A	\$39.95 EA

IGNITION SWITCH RETAINER

A "must have" part when installing an ignition switch. Zinc plated for years of service.



64-66
C4DZ-10A885-A

List

\$6.00 EA



67-68
C7ZZ-11A590-B

List

\$8.95 EA

NEUTRAL SAFETY SWITCH



These Neutral Safety Switches were unexpectedly made obsolete by Motorcraft and availability was getting scarce, but they are now made by Scott Drake and available once again! Our Classic Mustang neutral safety switches are high quality reproduction parts made from original Ford prints.

Year	Description	Part No.	List
64-67	C-4, before 12-15-66	C4AZ-7A247-C	\$49.95 EA
67-69	C-4, C-6, after 12-15-66	C9ZZ-7A247-B	\$49.95 EA
69-73	FMX	D2ZZ-7A247-B	\$108.95 EA
70-72	C-4	D0ZZ-7A247-B	\$59.95 EA

TURN SIGNAL SWITCH

Most are exact copies made by Scott Drake using original Ford prints. Our C5OZ-13341-BR switch is pictured below.



Year	Description	Part No.	List
64	Early	C3OZ-13341-B	\$74.95 EA
65-66	Reproduction	C5OZ-13341-BR	\$29.95 EA
67	W/out tilt	C7ZZ-13341-F	\$79.95 EA
67	W/tilt	C7ZZ-13341-E	\$129.95 EA
68	W/out tilt	C8SZ-13341-A	\$84.95 EA
68-69	W/tilt	C8SZ-13341-B	\$129.95 EA
69	W/out tilt	C9AZ-13341-B	\$79.95 EA
70-72	W/out tilt	D2AZ-13341-C	\$102.95 EA
70-72	W/tilt, requires splicing	D2AZ-13341-D	\$94.95 EA
73	W/tilt	D6AZ-13341-A	\$89.95 EA
73	W/out tilt	D6AZ-13341-B	\$74.95 EA

WE PROUDLY FEATURE AUTHENTIC MUSTANG REPRODUCTIONS FROM SCOTT DRAKE!



NEUTRAL SAFETY SWITCH HARNESS



Connects neutral safety switch to main underdash harness.

Year	Part No.	List
64-65	C5ZZ-7A240-NS	\$26.95 ^{EA}
66	C6ZZ-7A240-NS	\$28.95 ^{EA}

TURN SIGNAL HARNESS SOCKET

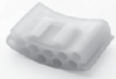

This hard to find part is now made by Scott Drake! This makes installing the Mustang turn signal switch easier. Made from ABS plastic using the original Ford print.

Year	Part No.	List
65-66	C5AZ-14489-H	\$6.95 ^{EA}
67	C7SZ-14489-B	\$6.95 ^{EA}
68-72	C8AZ-14489-S	\$5.95 ^{EA}

TURN SIGNAL CANCEL CAM



Great reproduction of an often broken part.

Year	Description	Part No.	List
65-66		C3DZ-13318-B	\$10.95 ^{EA}
67-71	W/out tilt	C7SZ-13318-B	\$10.95 ^{EA}
73		D0AZ-13318-A	\$10.95 ^{EA}
68-69	W/tilt	C8AZ-13318-A	\$4.95 ^{EA}

MISCELLANEOUS LIGHT BULBS



Replacement bulbs from O.E.M. suppliers to the auto industry. Excellent quality bulbs.

INTERIOR LIGHTS		BULB #
Dome Light	1967 - 70	1003
	Early 1971	105
	Late 1971 - 73	561
Door courtesy light	1965 - 68	1004
Fastback quarter panel	1964 - 70	1003
Floor shift indicator	1964	1445
	1965 - 73	1893
Console ash tray	1970	1892
Console glove box	1964	1445
	1965 - 70	1895
DASHBOARD LIGHTS		
LIGHTS		
Under-dash courtesy	1965 - 73	631
Glove box light	1965 - 73	1895
Cigar lighter	1967 - 73	1895
Ash tray	1970	1445

Radio dial light	1964 - 70	1893
Clock light	1967 - 73	1895
Heater control light	1969 - 70	1895
Ignition switch light	1969	1895
Seat belt warning light	1966	1895
	1967 - 73	1445
INSTRUMENT CLUSTER		
INSTRUMENT		
		BULB #
Instrument panel light	1964 - 68	1895
	1969 - 73	194
Turn signal indicator	1964 - 71	1895
	1972 - 73	194
Warning - Oil/Alt/Brakes	1964 - 71	1895
	1972 - 73	194
Bright indicator	1964 - 71	1895
	1972 - 73	194
Rally-Pac clock	1965 - 67	1816
Rally-Pac tach	1965 - 67	1895
EXTERIOR LIGHTS		
		BULB #
Parking light	1964 - 66	1157
	1967 - 73	1157A
Backup light	1964 - 69	1142
	1970 - 73	1156
Stop/turn signal	1965 - 73	1157
Hood mounted turn indicator	1967 - 68	53
	1969	1895
Rear side marker	1969 - 72	194
License plate light	1964 - 73	97

For headlights, see "Headlights" earlier in "Electrical & Lighting"

Light Bulb Pricing Table

Part No.	List
53	\$1.25 ^{EA}
90	\$1.50 ^{EA}
97	\$1.50 ^{EA}
105	\$3.00 ^{EA}
194	\$1.25 ^{EA}
561	\$2.50 ^{EA}
631	\$3.20 ^{EA}
1003	\$2.00 ^{EA}
1004	\$1.95 ^{EA}
1142	\$2.75 ^{EA}
1156	\$3.00 ^{EA}
1157	\$1.25 ^{EA}
1157A	\$2.95 ^{EA}
1445	\$1.75 ^{EA}
1816	\$3.00 ^{EA}
1892	\$2.00 ^{EA}
1893	\$1.50 ^{EA}
1895	\$1.25 ^{EA}

For headlights, see "Headlights" earlier in "Electrical & Lighting"

COMPLETE PARK LIGHT KIT



Kit includes one pair of parking lamp housings, pads, lenses, gaskets, bulbs and mounting hardware.

Retainers sold separately.

Year	Part No.	List
64-66	KIT-ELC-1	\$64.95 ^{KI}

CONCOURS PARKING LIGHT MASTER KIT



This Scott Drake concours parking lamp master kit includes everything needed to replace broken or missing parking lamps on 64-66 Mustangs. Each kit features precision engineered concours parking lamp assemblies with correct wiring, FoMoCo amber lenses, lens gaskets, lamp to body bezel pads, plastic lamp to fender grommets, 1157 bulbs and high quality hardware. Parking lamp retainers, if required, are available separately.



Year	Part No.	List
64-66	KIT-ELC-1-C	\$64.95 ^{KI}

PARKING LIGHTS

LED PARK AND TURN SIGNAL LIGHT

LED lights are brighter, more reliable, and run cooler than traditional bulbs.



64-66: Panel assembly
C5ZZ-13200-LED

List
\$37.50^{EA}



64-73: Amber 1157 Bulbs only
SD-1157-UB

List
\$59.95^{PR}

TURN SIGNAL/PARK LIGHT ASSEMBLY



Complete housing with wiring. Bulb & lens included unless stated otherwise.

Year	Description	Part No.	List
69	RH	C9ZZ-13200-A	\$51. ⁹⁵ EA
69	LH	C9ZZ-13201-A	\$51. ⁹⁵ EA
70	RH	D0ZZ-13200-A	\$51. ⁹⁵ EA
70	LH	D0ZZ-13201-A	\$51. ⁹⁵ EA



64-66: bulb & lens not included
C5ZZ-13206-B (RH) standard
C5ZZ-13207-B (LH) standard

List

\$24.⁹⁵ EA



64-66 Concours bulb and lens not included.

C5ZZ-13206-C (RH)
C5ZZ-13207-C (LH)
Both are show quality

List

\$49.⁹⁵ EA



67-68: Orange bulb
C8ZZ-13200-B

List

\$32.⁹⁵ EA



C7ZZ-13210/20-K
67-68: Complete assembly for RH or LH side which includes: main body, electric housing & socket assembly, pigtail, lens, bulb, gasket, and retainer
C7ZZ-13210/20-K (RH)
C7ZZ-13212/21-K (LH)

List

\$59.⁹⁵ KT

71-72

D1ZZ-13200-A (RH)
D1ZZ-13201-A (LH)



List

\$49.⁹⁵ EA

PARK LIGHT LENS

Made to original specifications.



C5ZZ-13208-WTR
64: White, w/
FoMoCo logo

List

\$5.⁵⁰ EA



C5ZZ-13208-AR
65-66: Amber, w/
FoMoCo logo

List

\$4.⁹⁵ EA



C5ZZ-13208-A
64-66: Amber,
w/out logo

List

\$3.⁹⁵ EA



C7ZZ-13208-A
67-68:
W/ FoMoCo logo

List

\$4.⁹⁵ EA



D0ZZ-13208/9
69-70:
w/ Ford logo

List

\$32.⁹⁵ PR



D1ZZ-13208/9
71-72: Amber,
W/ Ford logo

List

\$31.⁹⁵ PR

PARKING LIGHT RETAINER



Stamped steel and zinc plated to prevent rust. Secures parking light to valance. 67-68 pictured.

Year	Description	Part No.	List
64-66	RH	C5ZZ-13220-C	\$4. ⁹⁵ EA
64-66	LH	C5ZZ-13221-C	\$4. ⁹⁵ EA
67-68	RH	C7ZZ-13220-A	\$15. ⁹⁵ EA
67-68	LH	C7ZZ-13221-A	\$15. ⁹⁵ EA

PARK LIGHT LENS GASKET



Gray foam gaskets to seal lens against housing.

Year	Description	Part No.	List
64-66		C5ZZ-13211-A	\$1. ⁵⁰ PR
67-68		C7ZZ-13211-A	\$1. ⁵⁰ PR
70	Mach 1	C9WY-13211-A	\$2. ⁹⁵ PR
69-70		C9ZZ-13211-A	\$2. ⁹⁵ PR
71-72		D1ZZ-13211-A	\$2. ⁹⁵ PR

PARK LIGHT LENS KIT



This kit includes mounting pads, lenses, gaskets, bulbs and mounting hardware.

Year	Part No.	List
64-66	KIT-ELC-2	\$16. ⁹⁵ KI

PARK LIGHT LENS SCREW



Stainless steel to prevent corrosion.

Year	Description	Part No.	List
64-68	Set of 4	378716-S	\$1. ⁷⁵ SE

PARK LIGHT BEZEL



Very nice reproductions. Ready for paint. Sold in pairs.

Year	Description	Part No.	List
67-68	Unpainted	C7ZZ-13210/12	\$45. ⁹⁵ PR

PARK LIGHT SEAL



Molded sponge, protects paint from chipping.

Year	Part No.	List
64-66	C5ZZ-13217-A/B	\$4. ⁵⁰ PR

SIDE LIGHTS & REFLECTORS

MARKER TO BODY SEAL



These parts are precision die-cut for a great fit the first time.

Year	Description	Part No.	List
69	Set of 4	C9AZ-15A447	\$2. ⁵⁰ SE
70	Rear	D0ZZ-15A447	\$2. ⁵⁰ SE
71-73	Rear	D1ZZ-15A447	\$2. ⁵⁰ SE

QUARTER PANEL REFLECTOR



This side marker reflector mounts on the rear of the quarter panel nice reproductions. Ready for paint. Sold in pairs.

Year	Description	Part No.	List
68	Late, w/ FoMoCo logo	C8GY-13380-A	\$67. ⁵⁰ EA
68	Late, w/out logo	C8GY-13380-AR	\$49. ⁹⁵ EA

WE PROUDLY FEATURE AUTHENTIC MUSTANG REPRODUCTIONS FROM SCOTT DRAKE!





68: Early,
W/ FoMoCo logo
C8ZZ-13380-A



List
\$29.⁹⁵EA

SIDE MARKER BEZEL



68: Early, ready to paint, rear
C8ZZ-13381-A (RH or LH)

List
\$25.⁹⁵EA



69: Chrome, front or rear
C9AZ-15A440-A (RH or LH)

List
\$17.⁵⁰EA



70: Chrome, front
D0ZZ-15A440-R (RH)
D0ZZ-15A440-L (LH)

List
\$34.⁹⁵EA



70: Chrome, rear
D0ZZ-15A440-BR (RH)
D0ZZ-15A440-BL (LH)

List
\$39.⁹⁵EA



The bezel that surrounds
the marker lens.

Year	Description	Part No.	List
71-73	Ready to paint, front (RH & LH)	D1ZZ-15A440-A/B	\$44. ⁹⁵ PR
71-73	Ready to paint, rear (RH & LH)	D1ZZ-15A440-C/D	\$49. ⁹⁵ PR

FRONT SIDE MARKER LENS

A quality reproduction with correct clear or amber lens.



69
C9DZ-15A215-C
(RH or LH)



List
\$17.⁵⁰EA



70
D0ZZ-15201-A (RH)
D0ZZ-15201-A (LH)



List
\$20.⁹⁵EA



71-73
D1ZZ-15201-A (RH)
D1ZZ-15201-B (LH)



List
\$31.⁹⁵EA

REAR SIDE MARKER LENS



A quality reproduction with
correct red lens and
with FoMoCo logo.



Year	Description	Part No.	List
69	(RH or LH)	C9AZ-15A201-C	\$17. ⁵⁰ EA
70	(RH or LH)	D0ZZ-15201-R	\$24. ⁹⁵ EA
71-73	(RH)	D1ZZ-15A201-C	\$31. ⁹⁵ EA
71-73	(LH)	D1ZZ-15A201-D	\$31. ⁹⁵ EA

SIDE MARKER LIGHT ASSEMBLIES



Complete pair of
assemblies. Ready to
install. Correct amber
bulbs included. **MADE IN
U.S.A.**

Year	Description	Part No.	List
68	Right and left	C8ZZ-15A201-C/D	\$159. ⁹⁵ PR

SIDE MARKER SOCKET



Replacement light socket
for side markers.

Year	Description	Part No.	List
69-73		D0DZ-15434	\$7. ⁹⁵ EA

TAIL & BACK UP LIGHTS

BACK UP LIGHT KIT



This large
kit includes
backup
 housings,
pads, lenses,
gaskets,
bulbs and
installation
hardware.



Year	Description	Part No.	List
64-66	Concours, show quality, FORD licensed	KIT-ELC-7	\$74. ⁹⁵ KI
64-66	Standard	KIT-ELC-8	\$66. ⁹⁵ KI
67-68	Standard	KIT-ELC-7	\$74. ⁹⁵ KI

BACK UP LIGHT HOUSING



Great chrome, housings
include wiring pigtail.
Lenses, gaskets, and bulbs
sold separately. *



Year	Desc	Part No.	List
64-66	Concours RH	C5ZZ-15511-C*	\$34. ⁹⁵ EA
64-66	Concours LH	C5ZZ-15512-C*	\$34. ⁹⁵ EA
64-66	RH	C5ZZ-15511-A	\$24. ⁹⁵ EA
64-66	LH	C5ZZ-15512-A	\$24. ⁹⁵ EA
67-68	RH	C7ZZ-15511-BR	\$29. ⁹⁵ EA
67-68	LH	C7ZZ-15512-BR	\$29. ⁹⁵ EA

BACK UP LAMP, COMPLETE



Complete assembly,
ready to install.

Year	Description	Part No.	List
69-70	RH	C9Z-15511-A	\$39. ⁹⁵ EA
69-70	LH	C9Z-15511-B	\$39. ⁹⁵ EA

LED BACK UP LIGHT



These LED panels glow
white when illuminated.
Much brighter and
whiter than standard

bulbs. These lights are a great improvement over stock bulbs and compliment the LED Sequential Tail Light Kits. Available in a kit for 1964-68 Mustangs: Includes two lights and gaskets for both sides of the car, lens, and mounting screws. Also available are replacement bulbs that fit in your standard 1142 light sockets, for 1964-70 Mustangs. Lifetime warranty!

Year	Description	Part No.	List
64-70	Panels	SD-1142-RFB	\$99. ⁹⁵ KT
64-70	Bulbs	SD-1142-UB	\$39. ⁹⁰ PR

BACK UP LIGHT INSTALLATION KIT



This kit includes mounting
pads, lenses, gaskets, bulbs and
mounting hardware.

Year	Description	Part No.	List
64-66		KIT-ELC-9	\$15. ⁹⁵ KI

**SHOP WITH CONFIDENCE! WE OFFER SUPERIOR-QUALITY PARTS
FOR ALL YOUR MUSTANG RESTORATION NEEDS.**

BACK UP LIGHT LENS



Molded white lenses just like originals. Year either side.



Year	Description	Part No.	List
64-68	No logo	C5ZZ-15514-A	\$3.75 ^{EA}
64-68	W/ FoMoCo logo	C5ZZ-15514-AR*	\$4.25 ^{EA}
69-70	W/ FoMoCo logo	C9ZZ-15514-B*	\$10.95 ^{EA}
64-66	Amber - export	C5ZZ-15514-AMB	\$5.95 ^{EA}

BACK UP LIGHT LENS GASKET



Molded sponge, good fit. Seals lens to housing.

Year	Part No.	List
65-70	C5ZZ-15510-A	\$1.50 ^{PR}

BACK UP LIGHT LENS SCREW



Stainless steel to prevent corrosion.

Year	Description	Part No.	List
64-68	Set of 4	380438-S	\$1.50 ^{KI}

BACK UP LIGHT PIGTAIL



The harness that connects to the back up switch on 4 speed cars.

Year	Description	Part No.	List
70	4 speed	70-BU-4	\$31.50 ^{EA}

BACK UP LIGHT SWITCH



Our back-up switch features a weather sealed U.S. made switch with a zinc plated mounting bracket.

Part No.	Year	Description	List
C5ZZ-15520-A	64-66	4 speed	\$47.50 ^{EA}
C5ZZ-15520-C	64-66	3 speed	\$47.50 ^{EA}
C7ZZ-15520-A	67-68	4 speed	\$49.95 ^{EA}
C7ZZ-15520-C	67-68	3 speed	\$49.95 ^{EA}
C9ZZ-15520-A	69	4 speed	\$50.95 ^{EA}
DOZZ-15520-A	70-73	4 speed Hurst	\$29.95 ^{EA}
DOZZ-15541	70-73	4 speed Hurst Retainer	\$5.95 ^{EA}

REAR BUMPER LICENSE LAMP



Mounts on rear bumper. Good copy of original, includes lens, bulb and correct wiring pigtail.

Year	Part No.	List
64-70	C5ZZ-13550-A	\$29.95 ^{EA}
71-73	D1ZZ-13550-A	\$24.95 ^{EA}

LICENSE PLATE LIGHT LENS



A nice reproduction to replace those cracked and yellowed originals.

Year	Part No.	List
64-74	C4AZ-13564	\$10.95 ^{EA}

SEQUENTIAL CONTROL MODULE



These control modules feature variable rate adjusters and color coded wire harnesses. Perfect for custom tail lights. Note: requires STL-EVF-13350 Variable Flasher (below)

Year	Part No.	List
65-70	STL-13A366	\$119.95 ^{KI}

TAIL LIGHT 3 BULB INSERTS



These three bulb inserts enhances the brightness of the tail lamps by 200 percent. A simple "drop-in" insert. Can be used with or without our sequential controllers. C5ZZ-13450-PC lens recommended for 64-66.

Year	Description	Part No.	List
65-66	Twice the brightness	C5ZZ-STL-13400	\$39.95 ^{PR}
67-68		C7ZZ-STL-13400	\$39.95 ^{PR}
69		C9ZZ-STL-13400	\$39.95 ^{PR}
70		DOZZ-STL-13400	\$39.95 ^{PR}

TURN SIGNAL FLASHER

High quality replacement parts, may not appear original. Also used for emergency flashers.



65-70: Electronic Variable Flasher, for use w/ our sequential tail lights
STL-EVF-13350

List
\$14.95^{EA}

LED TAIL LIGHT BULBS

The world's brightest LED lights on the market for 1157 light sockets. Auto-parts store LED's don't even compare. Rear LED's glow red. 64-66 have lifetime warranty! Special flasher included.



C5ZZ-LED
64-66: Bulbs

List
\$89.95^{KIT}



C5ZZ-LED-SB
64-66: Super Bright Sequential LED Panels

List
\$99.95^{KIT}

SEQUENTIAL TAIL LIGHT KIT



These three bulb inserts enhance the brightness of the tail lights by 200 percent. A simple "drop-in" insert. 65-66 also available with pre-assembled housings. C5ZZ-13450-PC recommended for 64-66 cars.

Year	Part No.	List
65-66	C5ZZ-STL	\$144.95 ^{KI}
67-68	C7ZZ-STL	\$144.95 ^{KI}
69	C9ZZ-STL	\$144.95 ^{KI}
70	DOZZ-STL	\$144.95 ^{KI}

DELUXE SEQUENTIAL TAIL LIGHT KIT



Another new and unique product from Scott Drake. Scott's goal was to provide the classic Mustang with sequential turn signals like the T-birds and Shelby's of the 60's. The inserts alone increase the brightness of the taillamps by 200%. Our sequential light systems come complete with control modules, an electronic variable flasher and 2 dedicated three bulb inserts, ready to install in your taillamp housings. All required electrical connectors are provided. This deluxe kit comes with special polycarbonate lenses. We installed the three bulb inserts into our taillamp housings to make installation just that much easier. Detailed instructions included. Assembly required.

Year	Description	Part No.	List
65-66	Includes housing & high-temp lenses	C5ZZ-STL-DLX	\$199.95 ^{KI}

WE PROUDLY FEATURE AUTHENTIC MUSTANG REPRODUCTIONS FROM SCOTT DRAKE!



LED SEQUENTIAL TAIL LIGHT KIT (EASY INSTALL)

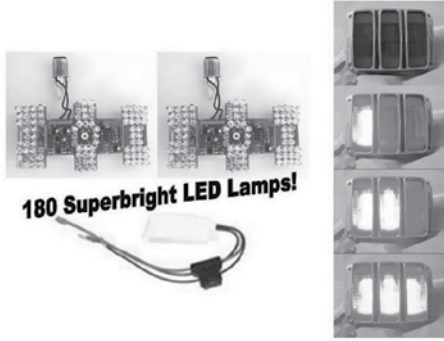

Drake Automotive Group has teamed up with an industry leader in LED Sequential Tail Light systems for the Ford Mustang. With patented "Smart-signal" technology and exclusive "Batwing" design, these kits offer easy hassle-free installation with no splicing required! These LED's are up to 5 times brighter than stock lights but run cooler and use less energy than traditional bulbs, so they won't melt your lenses. Each kit works with stock lenses and housings, so there is nothing extra to buy. Lifetime warranty! Please note: sequencing speed is not adjustable.

Year	Description	Part No.	List
65-66	Standard LED's	CSZZ-LED-STL	\$159.95 ^{KI}
64-66	Super bright LED's	SD-0005-UB	\$169.95 ^{KT}
67-68	Super bright LED's	SD-6004-UB	\$169.95 ^{KT}
67-68	Super bright LED's, Cal Spec/Shelby	SD-6009-UB	\$269.95 ^{KT}
69	Super bright LED's	SD-6003-UB	\$174.95 ^{KT}
70	Super bright LED's	SD-6010-UB	\$179.95 ^{KT}
71-73	Super bright LED's	SD-6012	\$233.95 ^{EA}

1964-66 TAIL LIGHT BEZEL

Made by Scott Drake, these are the best the market has to offer. Show-quality chrome and fit. We offer our bezels in original bright chrome, or satin chrome for a custom look.



Year	Description	Part No.	List
64-66	Show-quality, chrome	CSZZ-13489-AR	\$49.95 ^{PR}
64-66	Show-quality, satin	CSZZ-13489-S	\$49.95 ^{PR}
64-66	Economy, chrome - not made by Drake	CSZZ-13489-A	\$15.50 ^{EA}

1967-68 TAIL LIGHT BEZEL



All 67-68 tail light bezels come complete with pads and studs. Available individually or in a kit of 6. Also available in our new satin chrome finish for a custom look. These are the best on the market. Retaining nuts sold separately under part # 377523-S.

Year	Description	Part No.	List
67	Chrome	C7ZZ-13489-A	\$9.95 ^{EA}
67	Chrome, kit of 6	KIT-ELC-5	\$56.95 ^{KI}
67	Satin, kit of 6	KIT-ELC-5S	\$56.95 ^{KI}
68	Chrome	C8ZZ-13489-A	\$9.95 ^{EA}
68	Chrome, kit of 6	KIT-ELC-6	\$56.95 ^{KI}
68	Satin, kit of 6	KIT-ELC-6S	\$56.95 ^{KT}

69 TAIL LIGHT BEZEL

This tail light trim is made from original Ford tooling for a perfect fit. Also available with our '69 Tail Light Lens (C9ZZ-13450-A), see "Tail Light Lenses" later in this section.



69: Stainless
C9ZZ-13450-S

List
\$7.95^{EA}



69: Stamped aluminum
C9ZZ-13489

List
\$34.95^{EA}

70 TAIL LIGHT BEZEL



These are beautiful reproductions. Available with a bright chrome finish and black accent lines, or without a chrome finish for BOSS applications. Available in original Ford tooling or reproduction on chrome versions.

Year	Description	Part No.	List
70	Chrome, RH	DOZZ-13489-A [†]	\$124.95 ^{EA}
70	Chrome, LH	DOZZ-13489-B [†]	\$124.95 ^{EA}
70	W/out chrome, RH	DOZZ-13489-R [†]	\$119.95 ^{EA}
70	W/out chrome, LH	DOZZ-13489-L [†]	\$119.95 ^{EA}
70	Chrome, RH, repro	DOZZ-13489-AR	\$99.95 ^{EA}
70	Chrome, LH, repro	DOZZ-13489-BR	\$99.95 ^{EA}

BILLET TAIL LIGHT BEZEL

Made from a block of billet aluminum, featuring black button head screws, and are a perfect match to our billet gas caps. Scott Drake's new Sidewinder™ Billet Aluminum Tail Light Bezels for 1964 1/2 - 66 Mustangs.



B-13489-B
65-66: w/out accent lines

List

\$169.95^{PR}

SIDEWINDER™ BILLET TAIL LIGHT BEZEL



These new tail light bezels feature CNC machined T-6061 aluminum construction and a clear coat finish. The precision sculpting of their

low-profile design and the Scott Drake exclusive tri-bar side window give them a unique restomod appearance. The side window also delivers distinctive styling and added safety by making the tail lights visible from the side.

Year	Description	Part No.	List
65-66	Lens not included	B-13489-B	\$169.95 ^{PR}

SHELBY TAIL LIGHT BEZEL

High quality reproductions. Made in the U.S.A.



68-70: Shelby/
68 Cal Special,
chrome
CSZZ-13489-A



List

\$94.95^{EA}



67: Shelby,
satin
Aluminum
S7MS-13489



List

\$176.95^{PR}

TAIL LIGHT BEZEL SCREW



Exact copy of the original. Features stainless steel construction.

Year	Description	Part No.	List
64-66	Set of 8	50398-SK	\$3.95 ^{KI}

CONCOURS TAIL LIGHT HOUSING



Now available from Scott Drake, our Mustang Tail Light Housings. Officially licensed by Ford we feature steel construction,

zinc plating, the FoMoCo logo on both inside and outside with the SAE stamping just like the originals. We even include the bulbs! Our 1964 1/2 Mustang tail light housing is a concours correct restoration part that features superior fitment, correct size plugs and color coded wired sockets and are tested to ensure a trouble free installation.



Year	Description	Part No.	List
1964	LEFT Concours/FoMoCo logo	C4ZZ-13434-L	\$34.95 ^{SE}
1964	RIGHT Concours/FoMoCo logo	C4ZZ-13434-R	\$34.95 ^{SE}
65-66	LEFT & Right Concours FoMoCo logo - no pigtail	CSZZ-13434-B	\$26.95 ^{SE}

TAIL LIGHT HOUSING



65-66: Original plug in style, includes bulb
CSZZ-13434-A (RH or LH)

List

\$24.95^{EA}

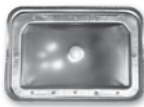

67-68
C7ZZ-13434-A (RH or LH)

List

\$46.95^{EA}



67: Shelby and Eleanor, ABS plastic housing
S7MS-13434 (RH & LH)

Call for Pricing and Availability



68: Steel Housings
C8ZX-13434 (RH & LH)

List

\$149.95^{PR}



69
C9ZZ-13434 (RH or LH)

List

\$74.95^{EA}



70
D0ZZ-13434 (RH or LH)

List

\$74.95^{EA}



71-73
D1ZZ-13434 (RH or LH)

List

\$49.95^{EA}

TAIL LIGHT HOUSING MOUNTING

NUT



These hard to find nuts are concours correct and

feature high-quality zinc plating. 64-66 pictured. 67-68 feature external lock washers like originals.

Year	Description	Part No.	List
64-66	Set of 8	359606-S8	\$5.95 ^{SE}
67-68	Set of 12	377523-S	\$4.95 ^{SE}

TAIL LIGHT HOUSING SPACER



Cadmium plated for corrosion resistance.

Year	Description	Part No.	List
64-66	Set of 8	CSZZ-13A547-AK	\$4.95 ^{KI}

TAIL LIGHT RETAINING BOLT



Year	Description	Part No.	List
69-73	Does not fit 1970	382764-S	\$1.75 ^{EA}

TAIL LIGHT HOUSING GASKET



This gasket goes between the tail light housing and the body of the car on 1964 through 1966 Mustangs.

Year	Part No.	List
64-66	C5ZZ-13420-A	\$1.95 ^{PR}
67-68	C7ZZ-13420-A	\$1.95 ^{EA}
69	C9ZZ-13420-A	\$6.25 ^{PR}

TAIL LIGHT HOUSING TO BODY SEAL



Thick black molded mounting pads which protect and seal trunk from water and dirt.

Year	Part No.	List
67-68	C7ZZ-13520	\$17.50 ^{EA}
69	C9ZZ-13520	\$29.95 ^{EA}
70	D0ZZ-13520	\$24.95 ^{EA}
71-73	D1ZZ-13520	\$17.50 ^{EA}

TAIL LIGHT LENS GASKET



Precision die-cut gaskets for hassle-free installation. Made from the original type of material in each case.

Year	Description	Part No.	List
64-66		C5ZZ-13461-B	\$1.95 ^{PR}
67-68		C7ZZ-13461-A	\$3.95 ^{PR}
67	Cougar and Shelby	C7WY-13461	\$8.95 ^{PR}
68-70	Shelby and Cal Special	C4SZ-13461-A	\$8.95 ^{PR}
69		C9ZZ-13461-A	\$4.95 ^{PR}

TAIL LIGHT LENS & BEZEL KIT

Kit includes 2 daily driver style bezels and lenses, 4 (inner & outer) gaskets, screws and mounting hardware. The 67-68 Kits includes Show Quality Bezels and Lenses, Mounting Bolts, Concours Nuts, Tail lamp Bezel Pad and Tail Lamp Lens Gasket.

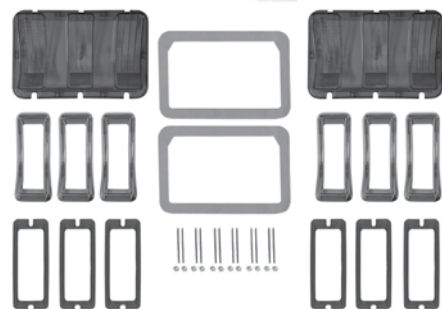

Year	Description	Part No.	List
64-66	Standard	KIT-ELC-3	\$46.95 ^{KI}
1967	Concours	KIT-ELC-5-DLX	\$119.95 ^{KI}
1968	Concours	KIT-ELC-6-DLX	\$119.95 ^{KI}

TAIL LIGHT LENS

Excellent injection molded part, with crisp detail and the correct red color.



64-66: Economy, no FoMoCo logo
CSZZ-13450-A

List

\$5.95^{EA}



64-66: w/ FoMoCo logo, concours
CSZZ-13450-AR

List

\$9.95^{EA}



65-66: Clear, (requires red bulbs)
CSZZ-13450-CLR

List

\$22.95^{PR}



64-66: High Temperature, for 3 bulb inserts
CSZZ-13450-PC

List

\$7.95^{EA}

WE PROUDLY FEATURE AUTHENTIC MUSTANG REPRODUCTIONS FROM SCOTT DRAKE!





67-68
C7ZZ-13450-A



List
\$29⁹⁵ EA



67: Cougar or Shelby
C7WY-13450

List
\$82⁵⁰



68-70: Shelby/68 Cal special
CSSZ-13450-C

List
\$42⁹⁵ EA



69: w/ stainless Trim
C9ZZ-13450-A



List
\$64⁹⁵ EA



70
DOZZ-13450

List
\$74⁹⁵ EA

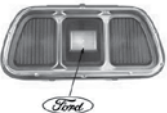

71-73: w/ bezel
D1ZZ-13450



List
\$104⁹⁵ EA

TAIL LIGHT WIRING HARNESS



Features the correct color coding for left hand tail lights. Exact copy of original weatherproofing rubber plug and connecting terminals.

Year	Desc	Part No.	List
64	Coupe & convertible W/out tail light plugs	C4ZZ-14405-CP	\$82 ⁹⁵ EA
65	Coupe and convertible	C5ZZ-14405-CP	\$109 ⁹⁵ EA
65	Fastback	C5ZZ-14405-FB	\$109 ⁹⁵ EA
66	Coupe and convertible	C6ZZ-14405-CP	\$109 ⁹⁵ EA
66	Fastback	C6ZZ-14405-FB	\$109 ⁹⁵ EA
67	Coupe and Fastback	C7ZZ-14405-65W	\$166 ⁹⁵ EA
67	Coupe and Fastback W/out low fuel warning light	C7ZZ-14405-65W0	\$149 ⁹⁵ EA
67	Convertible W/out low fuel warning light	C7ZZ-14405-76W0	\$139 ⁹⁵ EA
67	All	C7ZZ-14405-ALL	\$139 ⁹⁵ EA
68	Shelby/California Special	C8ZX-14405	\$214 ⁹⁵ EA

Year	Desc	Part No.	List
68	Coupe and convertible	C8ZZ-14405-CPCV	\$139 ⁹⁵ EA
68	Fastback	C8ZZ-14405-FB	\$144 ⁹⁵ EA
69	W/out safety group	C9ZZ-14405-A	\$209 ⁹⁵ EA
69	W/ safety group	C9ZZ-14405-B	\$234 ⁹⁵ EA
70	W/out light sockets	DOZZ-14405-A	\$204 ⁹⁵ EA
70	W/ light sockets	DOZZ-14405-WS	\$259 ⁹⁵ EA

TAIL LIGHT PIGTAIL



These are the correct color code and are just like the originals.

Year	Description	Part No.	List
65-66	LH	C40Z-13A408-AL	\$16 ⁹⁵ EA
65-66	RH	C40Z-13A408-AR	\$16 ⁹⁵ EA
67	Shelby	S7MS-13A408-A	\$99 ⁹⁵ PR
68	Shelby	S9MS-13A408-A	\$79 ⁹⁵ PR

UNDER-HOOD ELECTRICAL

ALTERNATOR HARNESS



Attaches to the back of alternator or generator. Plugs into main headlight harness and grounds to the block. Features

correct color coded terminal covers for water proofing electrical connections.

Year	Description	Part No.	List
64	6 cyl.	C4ZZ-14056-6GN	\$65 ⁹⁵ EA
64	V8	C4ZZ-14056-8GN	\$65 ⁹⁵ EA
65	6 cyl. w/ gauges	C5ZZ-14056-6WG	\$28 ⁹⁵ EA
65	6 cyl. w/ warning lights	C5ZZ-14056-6WL	\$28 ⁹⁵ EA
65	V8 w/ gauges	C5ZZ-14056-8WG	\$28 ⁹⁵ EA
65	V8 w/ warning lights	C5ZZ-14056-8WL	\$25 ⁹⁵ EA
66	6 cyl.	C6ZZ-14056-6	\$28 ⁹⁵ EA
66	V8	C6ZZ-14056-8	\$24 ⁹⁵ EA
67-68	6 cyl. w/out tachometer	C7ZZ-14056-6W0	\$28 ⁹⁵ EA
67-68	Big block w/out tachometer	C7ZZ-14056-BBWO	\$28 ⁹⁵ EA
67-68	Big block w/ tachometer	C7ZZ-14056-BBWT	\$35 ⁹⁵ EA
67-68	Small block w/out tachometer	C7ZZ-14056-SBWO	\$28 ⁹⁵ EA
67-68	Small block w/ tachometer	C7ZZ-14056-SBWT	\$28 ⁹⁵ EA
69	W/out tachometer	C9ZZ-14056-W0T	\$34 ⁹⁵ EA
69	W/ tachometer	C9ZZ-14056-WT	\$59 ⁹⁵ EA
70	W/out tachometer	DOZZ-14056-W0T	\$38 ⁹⁵ EA
70	W/ tachometer	DOZZ-14056-WT	\$64 ⁹⁵ EA
71	W/ instruments	D1ZZ-14056-WI	\$49 ⁹⁵ EA
71	W/out instruments	D1ZZ-14056-WOI	\$49 ⁹⁵ EA
72	W/ instruments	D2ZZ-14056-WI	\$52 ⁹² EA
72	W/out instruments	D2ZZ-14056-WOI	\$49 ⁹⁵ EA

ALTERNATOR TERMINAL COVER



Alternator terminal cover (some applications use two, while others three). Packaged as a 3 piece set.

Year	Part No.	List
67-70	C7ZZ-14056-ATC	\$6 ⁹⁵ SET

BATTERY TRAY MOUNTING KIT



Includes all hardware necessary to mount battery tray to inner fender apron.

Year	Part No.	List
64-66	CSZZ-10732-MK	\$5 ⁵⁰ KI

CONCOURS BATTERY CABLE KIT



Each of these great kits include all three required cables, including part numbers, proper terminal

and post clamp ends. Starter cables are properly shielded from heat. Most M.C.A. approved. Economy versions do not have part numbers, and terminal clamps are similar to originals.

Year	Description	Part No.	List
64	Concours, V8	C4ZZ-14300-8*	\$62 ⁹⁵ SE
64-66	Concours, 6 cyl.	CSZZ-14300-6	\$62 ⁹⁵ SE
64-66	Concours, V8	CSZZ-14300-8	\$62 ⁹⁵ SE
67	Concours, 6 cyl.	C7ZZ-14300-6	\$62 ⁹⁵ SE
67	Concours, V8	C7ZZ-14300-8	\$62 ⁹⁵ SE
68-69	Concours, heavy duty, 428CJ	C8ZZ-14300-428	\$66 ⁹⁵ EA
68-69	Concours, 6 cyl.	C8ZZ-14300-6	\$62 ⁹⁵ SE
68-69	Concours, V8	C8ZZ-14300-8	\$62 ⁹⁵ SE
68-69	Concours, heavy duty 4 gauge	C8ZZ-14300-HD*	\$66 ⁹⁵ SE
70-71	Concours, 6 cyl.	DOZZ-14300-6	\$62 ⁹⁵ SE
70-71	Concours, V8	DOZZ-14300-8	\$62 ⁹⁵ SE
70-71	Concours, heavy duty 4 gauge	DOZZ-14300-HD*	\$66 ⁹⁵ SE
72-73	Concours, 6 cyl.	D2ZZ-14300-6	\$62 ⁹⁵ SE
72-73	Concours, V8	D2ZZ-14300-8	\$62 ⁹⁵ SE
72-73	Concours, heavy duty 4 gauge	D2ZZ-14300-HD*	\$66 ⁹⁵ SE

STARTER SOLENOID CABLE BRACKETS



Kit includes two brackets and grommets for routing battery cable between starter and solenoid on inner fender.

Year	Part No.	List
64-73	CSZZ-14302-K	\$10 ⁹⁵ PR

SHOP WITH CONFIDENCE! WE OFFER SUPERIOR-QUALITY PARTS FOR ALL YOUR MUSTANG RESTORATION NEEDS.

BATTERY CABLE KIT



Similar quality as our concours cables but without concours correct markings. Cable is correct length. Great option for daily drivers. 6g wire or heavy duty 4g wire

Year	Description	Part No.	List
64-66	Economy (no part numbers)	C5ZZ-14300-E	\$39. ⁹⁵ SE
67-70	Economy (no part numbers)	C7ZZ-14300-E	\$40. ⁹⁵ SE
64-66	4g HD	C5ZZ-14300-HD	\$49. ⁹⁵ SET
67-70	4g HD	C7ZZ-14300-HD	\$50. ⁹⁵ SET

BATTERY CLAMP BOLT KIT



Carriage bolt and two nuts.

Year	Part No.	List
64-66	C5DZ-10718-MK	\$2. ⁵⁰ KI

AUTOLITE BATTERY COVER



Great at shows for an original look. Year over the top of any group 24 top-post battery with

recessed filler caps.

Year	Description	Part No.	List
64-73	Top cover, group 24	C1DZ-10655-BC	\$54. ⁹⁵ EA

BATTERY COVER TERMINAL EXTENDERS



Sometimes required when using our Autolite Battery Cover (C1DZ-10655-BC). Extends your battery

terminals back to original height after installing the cover.

Year	Description	Part No.	List
64-73	Use w/ C1DZ-10655-BC, Autolite Battery Cover	C1DZ-10655-TE	\$24. ⁹⁵ PR

BATTERY FENDER SHIELD

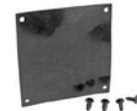

Rubberized sheet that shields the positive battery post from the inner fender. Kit includes original fasteners.

Year	Part No.	List
66	C6ZZ-10760-S	\$2. ⁹⁵ EA

BATTERY HOLD DOWN BOLT KIT



Kit comes complete with J bolts and mounting nuts.

Year	Description	Part No.	List
64-66	24F Series	D0AZ-10756-K	\$49. ⁹⁵ SET
67-70	24 F Series Stainless	D0AZ-10756-SS	\$14. ⁹⁵ SE

BATTERY HOLD DOWN CLAMP

Heavy duty stamped steel construction with black vinyl coating like the original to prevent corrosion.



67-70: 24F series, billet B-10718-BL

List
\$39.⁹⁵ EA



67-70: 24F series C5AZ-10718-A

List
\$6.⁹⁵ EA



64-66 C5DZ-10718-A

List
\$5.⁵⁰ EA

BATTERY HOLD DOWN CLAMP KIT

Includes battery clamp and bolt (or bolts) required to mount battery on tray.



67-70 C5AZ-10718-KIT

List
\$12.⁵⁰ KI



64-66 C5DZ-10718-KIT

List
\$6.⁹⁵ KI

BATTERY TRAY



Exactly like the originals. These battery trays are a popular item for restorers since most of the originals

have been destroyed by leaking batteries over the years.

Year	Description	Part No.	List
64-66	Black	C5ZZ-10732-C	\$14. ⁹⁵ EA
64-66	Use w/ "over the top" style clamp kit #C5AZ-10718-KIT)	C5ZZ-10732-D	\$18. ⁹⁵ EA
67-70	Black	C7ZZ-10732-D	\$14. ⁹⁵ EA
71-73	Black	D1ZZ-10732-B	\$18. ⁹⁵ EA

DISTRIBUTOR PRIMARY LEAD

PIGTAIL



Connects points and condenser, passes through distributor housing and plugs into distributor side of coil.

Year	Description	Part No.	List
64-68	6 cyl.	C5ZZ-12127-6PL	\$5. ⁹⁵ EA
64-68	V8	C5ZZ-12127-8PL	\$5. ⁹⁵ EA
64-66	High performance	C5ZZ-12127-HP	\$5. ⁹⁵ EA

ENGINE GAUGE FEED HARNESS



Plugs into firewall and connects original style oil pressure sending unit,

water temperature sending unit and coil. Also plugs into heater blower motor on 1964 - 1966 cars.

Year	Description	Part No.	List
64	6 cyl.	C4ZZ-14289-6	\$38. ⁹⁵ EA
64	V8	C4ZZ-14289-8	\$38. ⁹⁵ EA
65	6 cyl. w/ gauges	C5ZZ-14289-6WG	\$38. ⁹⁵ EA
65	6 cyl. w/ warning lights	C5ZZ-14289-6WL	\$38. ⁹⁵ EA
65	V8 w/ gauges & 3 speed heater	C5ZZ-14289-8WG3	\$41. ⁹⁵ EA
65	V8 w/ warning lights & 2 spd heater	C5ZZ-14289-8WL2	\$38. ⁹⁵ EA
65	V8 w/ warning lights & 3 spd heater	C5ZZ-14289-8WL3	\$34. ⁹⁵ EA
66	6 cyl.	C6ZZ-14289-6	\$41. ⁹⁵ EA
66	V8	C6ZZ-14289-8	\$34. ⁹⁵ EA
67-68	6 cyl.	C7ZZ-14289-6	\$28. ⁹⁵ EA
67-68	Big block	C7ZZ-14289-BB	\$28. ⁹⁵ EA
67-68	Small block w/out tachometer	C7ZZ-14289-SBWO	\$26. ⁹⁵ EA
67-68	Small block w/ tachometer	C7ZZ-14289-SBWT	\$26. ⁹⁵ EA
68	Small block w/ AC	C8ZZ-14289-SBAC	\$32. ⁹⁵ EA
69-70	351W w/ AC	C9ZZ-14289351AC	\$28. ⁹⁵ EA
69-70	6 cyl.	C9ZZ-14289-6	\$28. ⁹⁵ EA
69-70	Big block	C9ZZ-14289-BB	\$28. ⁹⁵ EA
69-70	302, 351W	C9ZZ-14289-SB	\$28. ⁹⁵ EA
69-70	Boss 302	C9ZZ-14289-B302	\$31. ⁹⁵ EA
70	351 Cleveland	D0ZZ-14289-351C	\$25. ⁹⁵ EA
71-73	351 Cleveland	D1ZZ-14289-351	\$32. ⁹⁵ EA
71	429	D1ZZ-14289-BB	\$40. ⁹⁵ EA
71-72	302	D1ZZ-14289-SB	\$28. ⁹⁵ EA
72	351-4V w/ Tach	D2ZZ-14289-351T	\$48. ⁹⁵ EA

WE PROUDLY FEATURE AUTHENTIC MUSTANG REPRODUCTIONS FROM SCOTT DRAKE!



ENGINE OR TRUNK LIGHT



This handy little lamp can be mounted under the hood or the trunk lid. Features a gravity switch that turns the light on when the lid is raised and off when lowered.

Year	Part No.	List
64-73	C2RZ-15A700-A	\$41.95 ^{EA}

ENGINE TO FIREWALL GROUND WIRE



Original style heavy gauge black wire with correct terminals. Concours version has Ford part number stamped on wire & includes

original mounting hardware. Concours version picture. Wire only version does not have FoMoCo markings.

Year	Description	Part No.	List
64-68	Black wire only	C5ZZ-14289-GW	\$5.95 ^{EA}
64-68	Concours	FDA-14303-A*	\$8.95 ^{SE}

ELECTRIC HORNS (CONCOURS)



Look and sound just like the factory horns.

Year	Description	Part No.	List
65-66	High pitch, concours	C5ZZ-13832-H	\$36.95 ^{EA}
65-66	Low pitch, concours	C5ZZ-13833-L	\$36.95 ^{EA}
67-68	High pitch, concours	C7ZZ-13832-H	\$36.95 ^{EA}
67-68	Low pitch, concours	C7ZZ-13833-L	\$36.95 ^{EA}
69-70	High Pitch, concours	B8AZ-13832-B	\$36.95 ^{EA}
69-70	Low Pitch, concours	B8AZ-13833-B	\$36.95 ^{EA}

ELECTRIC HORNS (UNIVERSAL)



Replacement horn, Year all years. Plastic Housing

Year	Description	Part No.	List
64-73	High pitch, universal	C5ZZ-13832-A	\$21.95 ^{EA}
64-73	Low pitch, universal	C5ZZ-13833-A	\$21.95 ^{EA}

OIL PRESSURE EXTENSION LEAD



Oil pressure extension lead with braided yarn covering. Year C9ZZ-9278-A.

Year	Description	Part No.	List
64-66	W/ gauges	C6ZZ-14289-PT	\$8.95 ^{EA}

OIL PRESSURE SENDING UNIT

These senders screw into block and activate warning light when oil pressure is lost or give accurate reading to oil pressure gauge on cars equipped with gauges.



64-65: Warning light
67-70: w/ factory tach
B6AZ-9278-A

List
\$8.50 ^{EA}



67-68: Without factory tach, with spade connector
C7ZZ-9278-A

List
\$27.95 ^{EA}



65-66: w/ oil pressure gauge
69-73: w/ oil pressure gauge
C9ZZ-9278-A

List
\$25.95 ^{EA}

OIL PRESSURE SENDER ADAPTER



Machined brass adapter threads on to C9ZZ-9278-A sender. This allows the use of

C9ZZ-9278-A oil pressure sender on 1967-1968 vehicles. Correct style 67-68 sender is no longer available.

Year	Part No.	List
67-68	C7ZZ-9278-ADAPT	\$3.75 ^{EA}

HORN RELAY



Mounts on the radiator support for generator equipped cars.

Year	Part No.	List
64	C4DZ-13583-A	\$36.95 ^{EA}

REV LIMITER REPAIR PIGTAIL



Easily repairs damaged leads.

Part No.	Year	List
D0ZZ-12450-RL	69-71	\$34.95 ^{EA}

VOLTAGE REGULATOR MOUNTING KIT



3 piece kit. Correct screws to mount voltage regulator.

Year	Part No.	List
65-67	VRM-C5ZL-404	\$2.95 ^{KI}
68	VRM-C8ZL-406	\$2.95 ^{KI}

STARTER SOLENOID



This is a good quality starter solenoid at competitive price.

Year	Description	Part No.	List
64-73	Aftermarket	B6AZ-11450-A	\$9.95 ^{EA}
65	Concours	C5AZ-11450-A*	\$36.95 ^{EA}
66	Concours	C6AZ-11450-A*	\$36.95 ^{EA}
67-71	Concours	C7AZ-11450-A*	\$32.95 ^{EA}
72-73	Concours	D2AF-11450-A*	\$36.95 ^{EA}

CONCOURS VOLTAGE REGULATORS



We stock these original appearing regulators for all 1965-1973 Mustangs. Features the proper cover and original logos.

Year	Description	Part No.	List
64	Generator not concours Aftermarket	C2AF-10505-BR*	\$74.95 ^{EA}
65	Early 65, w/ FoMoCo logo	C5AF-10316-A*	\$51.95 ^{EA}
65-67	Early 67, black & silver w/ Autolite logo	C5AF-10316-B*	\$51.95 ^{EA}
65-67	W/ AC, black & yellow w/ Autolite logo	C5TF-10316-A*	\$51.95 ^{EA}
68-70	W/out AC, blue & silver w/ Autolite logo	C8AF-10316-A*	\$51.95 ^{EA}
68-69	W/ AC, blue & yellow w/ Autolite logo	C8TF-10316-A*	\$51.95 ^{EA}
68-69	W/ AC, blue & yellow w/ Autolite logo - economy reproduction	C8TF-10316-BR*	\$36.95 ^{EA}
70-71	W/out AC, blue & silver w/ Autolite logo	D0AF-10316-A*	\$51.95 ^{EA}
72	W/out AC, blue & silver w/ Motorcraft logo	D2AF-10316-A*	\$51.95 ^{EA}
72	W/ AC, blue & yellow w/ Autolite logo	D2TF-10316-A*	\$51.95 ^{EA}
73	W/out AC, blue & silver w/ Autolite logo	D3AF-10316-A*	\$51.95 ^{EA}
73	W/ AC, blue & yellow w/ Autolite logo	D3TF-10316-A*	\$51.95 ^{EA}

VOLTAGE REGULATOR COVER

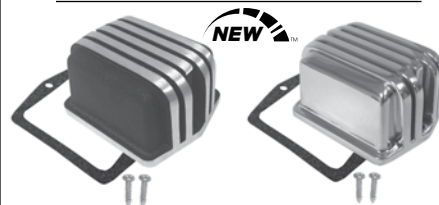

Choose from black wrinkle powder coat with machined fins or polished aluminum with machined fins. Gasket and hardware included.

Year	Description	Part No.	List
65-73	Black with machined fins	C5AF-10316-ALB	\$29.95 ^{EA}
65-73	Polished aluminum with machined fins	C5AF-10316-ALR	\$32.50 ^{EA}

RADIO SUPPRESSOR



Scott Drake is happy to announce the availability of radio suppressors for the classic Mustangs. All feature correct zinc plating, wiring

connections, Ford numbers, and markings. These radio suppressors were installed on 65-71 Fords that were originally equipped with a radio. Radio suppressors mount near the voltage regulator.

Year	Part No.	List
65	C35A-18832-A	\$29.95 EA
66	C60A-18832-A	\$29.95 EA
67-71	C60A-18832-AL	\$29.95 EA

VOLTAGE REGULATOR SCREW CAPS



Plastic caps used to cover sharp points on screws that mount voltage regulator. Sold in pairs.

Part No.	Year	List
C5Z-10316-S	64-66	\$2.50 PR

WIRES

WIRE LOOM MOUNTING KIT



Includes all loom straps, anchors, and clips necessary to correctly install wiring looms underneath the hood. These are excellent reproduction that feature excellent fit with concours appearance.

Year	Part No.	List
64-66	C5Z-14000-BK	\$11.50 KI
67	C7Z-14000-BK	\$17.95 KI
68	C8Z-14000-BK	\$17.95 KI
69	C9Z-14000-BK	\$23.95 KI

WIRE LOOM CLIP MASTER KIT



Typical kit does wiring at: battery tray, crossmember, doors, engine feed, fender apron, firewall, gas tank sender, horns, parking lights, tail lights, and under-dash. Note: Includes most common wiring clips, but may not include all clips on the car.

Year	Part No.	List
65-66	C5Z-WCK	\$39.95 KT
67	C7Z-WCK	\$27.95 KT
68	C8Z-WCK	\$32.95 KT
69	C9Z-WCK	\$51.95 KT
70	D0Z-WCK	\$57.50 KT
71-73	D1Z-WCK	\$34.95 KT

UNDERHOOD TURN SIGNAL WIRING CLIPS



These Scott Drake exclusive wire harness clips are great little reproductions with a black or bright chrome finish to catch the eye.

Year	Description	Part No.	List
67-68	Black set of 5	377774-S	\$8.95 SE
67-68	Chrome set of 5	377774-C	\$5.95 SE
67-68	Black 6 piece ABS	377774-C	\$11.95 SE

WIRE HARNESS CLIP



Vinyl dipped. Clip is used to hold wiring away from hot engine parts, often attached to LH valve cover bolt. Also found on trunk floor.

Year	Part No.	List
64-73	356640-S100	\$5.95 KI

EMBLEMS

EMBLEM KIT

Scott Drake is the world's premier manufacturer of Classic Mustang emblems with unmatched quality, variety, and packaging. These kits add the perfect finishing touch to any Mustang restoration. Each kit includes every correct emblem for the exterior of your car, and barrel clips are included.



65-66: 6 cyl., Fastback
C5Z-6340282-6K



List

\$45.95 KI



65-66: V8, Fastback
C5Z-6340282-8K



List

\$61.95 KI



65-66: 6 cyl., coupe & convertible
C5Z-6540282-6K



List

\$41.95 KI



65: GT
C5Z-65402828GT



List

\$73.95 KI



65-66: V8, coupe & convertible
C5Z-6540282-8K



List

\$57.95 KI



66: GT
C6Z-65402828GT



List

\$72.95 KI



67: 6 cyl.
C7Z-6540282200



List

\$68.95 KI



67: 289
C7Z-6540282289A



List

\$71.95 KI



67: 302
C7Z-6540282302



List

\$71.95 KI



67: 390
C7Z-6540282390



List

\$82.95 KI



67: GT, 4 speed
C7Z-6540282-2GT



List

\$85.95 KI



67: GT, automatic
C7Z-6540282GTA



List

\$93.95 KI



68: 200, 6 cyl.
C8Z-6540282200



List

\$48.95 KI



68: 289
C8Z-6540282289



List

\$52.95 KI

WE PROUDLY FEATURE AUTHENTIC MUSTANG REPRODUCTIONS FROM SCOTT DRAKE!





68: 302
C8ZZ-6540282302



List
\$52.95 KI



68: 390
C8ZZ-6540282390



List
\$64.95 KI



68: GT
C8ZZ-6540282-GT



List
\$54.95 KI



69-72: All
C9ZZ-6540282KIT



List
\$31.95 KI

FENDER EMBLEM



64-65: 260
C4DZ-16228-C

List
\$9.95 EA



64-66: 289, die-cast zinc, chrome plated
C30Z-16228-B

List
\$8.95 EA



64-66: 289
Concours, cold-forged alum w/ clear anodizing
C30Z-16228-A

List
\$19.95 EA



64-66: 302
C30Z-16228-302

List
\$13.95 EA



64-66: 347
C30Z-16228-347

List
\$14.95 EA



64-66: 351
C30Z-16228-351

List
\$14.95 EA



64-66: 5.0
C30Z-16228-5.0

List
\$14.95 EA



65-66: High performance
(Year any Scott Drake "V-Badge")
C5Z-16228-B

List
\$9.95 EA



64-66: High output
(Year any Scott Drake "V-Badge")
C5Z-16228-HO

List
\$14.95 EA



69-70: 351 Fender Emblem
C9Z-16228-A

List
\$29.95 EA



64-73: Powered By
Ford, stick-on
S2MS-16228-A



List
\$26.95 EA

GT FENDER EMBLEM



65: GT, economy
C5Z-16098-D

List
\$11.95 EA



65: GT, Concours, genuine
doisonne
C5Z-16098-DC

List
\$21.95 EA



66: GT
C60Z-16098-B

List
\$11.50 EA



67: GTA, automatic
C70Z-16098-A

List
\$38.95 EA



67: GT, 4 speed
C7Z-16098-A/B

List
\$34.95 EA



68: GT
C7GY-16098-B

List
\$22.95 EA

MUSTANG SCRIPT FENDER EMBLEM



64: Mustang, early
4 1/2" version
C5Z-16098-A



List
\$10.50 EA

MUSTANG

65-66: Mustang
C5Z-16098-B



List
\$7.95 EA

MUSTANG 2+2

65-66: Mustang 2+2
C5Z-16098-C



List
\$9.95 EA



68: Mustang script
C8ZZ-16098-A



List
\$9.95 EA



69-73: Mustang
script, fender and trunk
C9Z-16098-A



List
\$9.95 EA

RUNNING HORSE FENDER EMBLEM

*Please note: Ford switched to larger pins on back of running horse mid 1968, this included service replacement parts for early cars. Our running horses have correct early version small pins.



64-66: All
67-68: 6 cyl
C5ZZ-16228-D RH
C5ZZ-16228-D LH



List
\$9.95 EA



64-68: **stick-on**,
Sold as a pair LH & RH
C5ZZ-16228/9-SK



List
\$24.95 PR



65-68: 4.6
C7ZZ-16228-4.6, RH
C7ZZ-16228-4.6 LH



List
\$17.95 EA



65-68: 5.0
C7ZZ-16228-5.0 RH
C7ZZ-16228-5.0, LH



List
\$-EA



67-68: 289
*Early small pin version
C7ZZ-16228-C, RH
C7ZZ-16228-C, LH



List
\$11.95 EA



67-68: 289, **stick-on**,
Sold as a pair LH & RH
C7ZZ-16228/9-SK



List
\$26.95 PR



68: 302
Early small pin version
C8ZZ-16228-A RH
C8ZZ-16228-A LH



List
\$11.95 EA



68: 302, **stick-on**,
sold as a pair LH & RH
C8ZZ-16228/9-SK



List
\$26.95 PR



67-68: 351, RH
*Early small pin
version
C7ZZ-16228-W RH
C7ZZ-16228-W LH



List
\$17.95 EA



67-68: 390, RH
*Early small pin
Version
C7ZZ-16228-D RH
C7ZZ-16228-D LH



List
\$17.95 EA

SHELBY FENDER EMBLEM



69: Flat Cobra snake
C90B-16228-A RH
C90B-16228-A LH



List
\$21.95 EA



68-70: Cobra, fender
and roof
C90B-16720-A



List
\$29.95 EA



64-73: Cobra, RH
F6ZZ-16228-A



List
\$12.50 EA



64-73: Cobra, LH
F6ZZ-16228-B



List
\$12.50 EA



67: Shelby GT350
S7MS-16098-A



List
\$54.95 EA



67: Shelby GT500
S7MS-16098-B



List
\$54.95 EA



68: Cobra
S8MS-16098-S



List
\$54.95 EA



68: 428 Cobra Jet
S8MS-16098-G

List
\$46.95 EA



69-70: Shelby
S9MS-16098-A



List
\$29.95 EA



69-70: 428 Cobra
Jet for GT500
S9MS-16C144-A

List
\$31.95 EA

GRILLE EMBLEM

Perfect detail. Mounting hardware included.



66: Running horse
for Shelby, concours
S2MS-8202-K



List
\$21.95 KI



69: Running horse
C9ZZ-8213-AR



List
\$39.95 KI



70: Running horse
D0ZZ-8213-A



List
\$29.95 EA



71-73: Running horse w/ tribar,
for Mach 1
D1ZZ-8213-B



List
\$21.95 EA



67: Shelby GT350 grille, dash
or deck
S7MS-16098-C



List
\$54.95 EA



67: Shelby GT500 grille, dash
or deck
S7MS-16098-D



List
\$54.95 EA



69-70: Shelby
S9MS-16098-A



List
\$29.95 EA

BILLET GRILLE EMBLEM MOUNTING CLIPS



These steel clips are
specially designed to
mount the C5ZZ-16229-B
Running Horse
Fender Emblem
to a billet grille.



Year	Part No.	List
64-11	C5ZZ-16229-BGMC	\$9.95 PR

HOOD LETTERS

FORD or "SHELBY" hood letters. Only the
best. Includes fasteners.



64-66: FORD pin version
C40Z-6240282A/D



List
\$10.95 SE



64-66: FORD **stick-on**
C40Z-6240282-SK



List
\$12.50 SE



67: FORD pin version
C7AZ-16606-A/D



List
\$11.95 SE



67: FORD **stick-on**
C7AZ-16606-SK



List
\$12.95 SE



68-70: SHELBY, chrome, pin
version
S8MS-16606-A/E



List
\$49.95 SE

68-70: Shelby **stick-on**
S8MS-16606-S



List
\$54.95 SE

**WE PROUDLY FEATURE AUTHENTIC MUSTANG
REPRODUCTIONS FROM SCOTT DRAKE!**



HOOD SCOOP EMBLEM

Emblem to go on the sides of the hood scoop. Sold individually.



69: 351, black and chrome, diecast
C9Z-16637-C

List
\$29.95 EA



69-70: 390, black and chrome, diecast
C9Z-16637-D

List
\$29.95 EA



69: 428, black and chrome, diecast
C9Z-16637-B

List
\$29.95 EA



69-70: Chrome Cobra Jet script
C9Z-16720-A

List
\$28.95 EA

QUARTER PANEL EMBLEM

Emblems made to factory original specifications.



68: California Special
C8ZX-65291A36-A

List
\$49.95 EA

ROCKER MOLDING EMBLEM

Beautiful Reproduction made out of Pressure Die Cast Zinc just like the originals. These can be swedged on like the factory did it or we have included speed clips for a quick and easy install. 2 sets required per car. Satin chrome like the originals!



70: Mach 1
DOZZ-16003-K

List
\$74.95 SE

ROOF EMBLEM



69-70: Coiled snake, Convex for roof
C90B-6542508-A

List
\$24.95 EA



69 Pillar ornament, set of 2
C9Z-63517A201A

List
\$134.95 PR



69-70: Shelby
S9MS-16229-A

List
\$24.95 EA

TAIL LIGHT PANEL EMBLEM



This fine reproduction is die-cast zinc for crisp letters and brushed to duplicate the finish on the original parts. Requires two medium barrel clips (P/N 375890-S).

Year	Description	Part No.	List
65-66	GT 350	S1MS-16098-A ^s	\$22.95 EA

TRUNK & FENDER EMBLEM

Die cast zinc painstakingly deburred and chrome plated. Trouble-free mounting. Sold in sets, includes fasteners or 3 M adhesive.



65-72: Mustang, pin version
C5ZZ-6540282A/G

List
\$14.95 SE



65-72: Mustang, Stick on
C5ZZ-6540282-SK

List
\$14.95 SE



70: Mach 1 Trunk, chrome, concours
DOZZ-6340228-KR

List
\$59.95 SE

INTERIOR EMBLEMS

DASH PANEL EMBLEM

Excellent reproductions.



67-68: Running Horse, red & silver, very small 7/8"X3/8", Adhesive backed
C7Z-65044A90-E

List
\$3.95 EA



67-68: Running horse tribar emblem w/ base, for Deluxe interior
C7Z-65044A90EP

List
\$34.95 EA



67-68: Running Horse tribar emblem w/out base, for Deluxe interior
C7Z-65044A90-M

List
\$19.95 EA



67-68: Running horse base only, for Deluxe interior
C7Z-65044A90-P

List
\$14.95 EA



69-70: Outer chrome bezel only
C9Z-6304460

List
\$26.95 EA



69-70: Mach 1, Insert only
C9Z-6304460-AI

List
\$18.95 EA



69-70: Mustang, Insert only
C9Z-6304460-BI

List
\$18.95 EA



69-70: Grande, Insert only
C9Z-6304460-GI

List
\$19.95 EA



71-73: Mustang Script, except Grande
D1ZZ-6504774-EM

List
\$15.95 EA



69-70: Cobra GT 350
S9MS-6304460-A

List
\$14.95 EA



69-70: Cobra Jet GT 500
S9MS-6304460-B

List
\$14.95 EA



67: Shelby GT350 Grille, dash or deck
S7MS-16098-C

List
\$54.95 EA



67: Shelby GT500 Grille, dash or deck
S7MS-16098-D

List
\$54.95 EA



68: Cobra Jet
S8MS-6304460-E

List
\$64.95 EA

DOOR PANEL EMBLEM



Beautiful detail. Features bright chrome finish and paint. Hardware included.



Year	Description	Part No.	List
69-70	69: All / 70: Deluxe	C9ZB-6520820/3	\$23.95 PR

SHELBY SEAT BELT INSERT EMBLEM

They are the most authentic and best looking emblems available.



67: Shelby Cobra
S7MS-63611A73-A



List
\$7.95 PR



68: Shelby Cobra, gold
S8MS-63611A73-A



List
\$7.95 PR



69-70: Shelby
S9MS-63611A73-A



List
\$7.95 PR

GLOVE BOX EMBLEM



Pressure die cast, excellent reproductions. Perfect chrome, stripes are painted correct colors.



Year	Description	Part No.	List
64-65	Running horse, curved	C4ZB-65060A14-A	\$9.95 EA
65-66	Running horse, flat	CSZB-65060A14-A	\$9.95 EA

COBRA INTERIOR EMBLEM

This small medallion can be used for insertion in shift knobs or other interior applications. 1" diameter.



64-73
286-101-A



List
\$24.95 EA

SILL PLATE EMBLEM

This aluminum emblem mounts on the center of all scuff plates. Features raised script like original, adhesive backed & protective coating.



64-66: Black,
Ford logo
CSZZ-6513208-T



List
\$2.50 EA



67-73: Blue, Ford logo
C7ZZ-6513208-T



List
\$2.50 EA



68-73: Blue, Ford logo
C8ZZ-6513208-T



List
\$2.50 EA



65-66: Shelby
S1MS-6513208-T



List
\$19.95 PR

STEERING WHEEL EMBLEM

The most authentic and best looking emblems available.



67: Running horse
C7ZZ-3649-A



List
\$24.95 EA



68: Running horse
C8ZZ-3649-AR



List
\$29.95 EA



69: For 1969 3-spoke style
Steering wheel
C9ZZ-3649-B



List
\$21.95 EA



70: For 1970 3-spoke style
Steering wheel
D0ZZ-3649



List
\$23.95 EA



69-70: Shelby Cobra
C9MS-3649-A



List
\$22.95 EA



67-73: For use on 2-
Spoke wheel
C9ZZ-3649-S



List
\$18.95 EA

ENGINE

AIR CLEANERS & VALVE COVERS

DOUBLE HUMP HIPO AIR CLEANER



A Scott Drake is proud to announce the release of new reproduction "Double Hump" HiPo Air Cleaner Assemblies.

These authentic units are modeled after the extremely rare 14" air cleaners that were standard on 260s and early HiPo 289s found in 1964-1/2 - 1965 Mustang, 1963 - 1965 Ford Falcon, 1963 - 1964 Shelby Cobra, 1963 - 1965 Ford Fairlane, and 1963 - 1965 Falcon Sprint. Unlike other HiPo air cleaner assemblies, these feature a unique "Double Hump" chrome lid rather than the more common "flat top" lid used on later model HiPo engines. The lid also has two indents to lock the wing-nut in place securely. The base of the assembly omits the breather port and is finished in a semi-gloss black like the originals. Attention was paid to the filter as well to match the original design with a yellow filter element, a round hole perforated screen and orange gasket material to complete the authentic appearance. Make your restoration or clone stand out from the crowd with this premium quality reproduction of the highly sought after "double hump" air cleaner. Like all Scott Drake products, these are backed by the Scott Drake Satisfaction Guarantee.

Year	Description	Part No.	List
63-65	Double hump	C4DZ-9600-C	\$89.95 EA

14" SPUN ALUMINUM HIPO AIR CLEANER ASSEMBLY

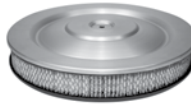

Add a custom hot rod look under the hood of your car with the Scott Drake 14" aluminum HiPo air cleaner assembly. These high

performance air cleaners are modeled after the chrome "flat-top" HiPo air cleaners that originally came on K-code Mustangs. These feature a brushed finish aluminum lid, a high flow white filter element and a blue stamped steel base. The base is equipped with a PCV port on the bottom. These are engineered to fit most brands of Ford 2v and 4v carburetors. Like all Scott Drake products, these are backed by the Scott Drake 100% satisfaction guarantee. Note: Air cleaner stud and wing nut sold separately.

Year	Description	Part No.	List
64-73	Spun aluminum	CSZZ-9600-AL	\$18.95 EA

WE PROUDLY FEATURE AUTHENTIC MUSTANG REPRODUCTIONS FROM SCOTT DRAKE!



390 GT AIR CLEANER ASSEMBLY

New by Scott drake is the extremely rare 1967 Mustang 390 GT High Performance Air Cleaner without the emissions control tube. This air cleaner is a Concours Reproduction that includes blue base and chrome lid. This is also an excellent stock appearing performance upgrade for the very restrictive 68-70 390-428 Air Cleaners. Some early production 1968 390 GT's may have come factory with this air cleaner. For California Emissions see part C7ZZ-9600-E. Note: the outside dimension of the lid is 16.75" and will not fit the more common 17" versions.



1967 Mustang 390 GT High Performance Air Cleaner Without EM tube
C7Z-9600-E

List
\$394.95 EA



1967-68 Early Mustang 390 GT High Performance Air Cleaner With CA EM tube
C7Z-9600-C

List
\$394.95 EA



1967 390, B302, CJ Chrome A/C LID Fits 69-70 Boss 302 and 428 CJ
C7Z-9661-A

List
\$189.95 EA



1969, 390, 428 CJ Air Cleaner Base Concours with no Shaker
C90Z-9600-H

List
\$474.95 EA

AIR CLEANER

These are complete air cleaner assemblies. Includes top, bottom and filter element.



64-65: V8 Chrome/gold, concours, Chrome lid & filter, inc. 289 HiPo decal
CSZZ-9600-G

List
\$44.95 SE



65-67: V8 Chrome/blue, concours, Chrome lid & filter, inc. 289 HiPo decal
CSZZ-9600

List
\$44.95 SE



64-73: High performance, economy, chrome top w/ blue bottom, inc. 289 HiPo decal
CSZZ-9600-W

List
\$27.95 EA



64-73: High performance, economy, chrome top w/ blue bottom, inc. 302 HiPo decal
C8ZZ-9600-W

List
\$29.95 EA

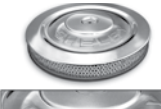

64-73: Shelby HiPo Air Cleaner Assembly
S1MS-9600-S

List
\$49.95 EA



64-73: Cobra HiPo Air Cleaner Assembly
S1MS-9600-COBRA

List
\$49.95 EA



64-73: 6 cyl., 1.89" opening
C4DZ-9600-W

List
\$35.95 EA



64-73: 6 cyl., 200-250 w/ Autolite, 1.89" opening, concours, chrome lid and filter
C4DZ-9600

List
\$44.95 EA

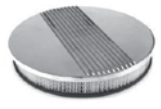

64-73: V8 14" Polished Aluminum Finned
CSZZ-9600-AFK

List
\$74.95 KT



64-73: V8 Oval Chrome plated - economy
S1MS-9600-CHR

List
\$49.95 EA



64-73: V8 14" Polished Aluminum Finned
C8ZZ-9600-M

List
\$129.95 KT



64-73: V8 14" Polished Aluminum Finne
S7MS-9600-CS

List
\$129.95 KT



64-73: Oval shape W/ Mustang logo
CSZZ-9600-M

List
\$134.95 EA



64-73: Oval shape W/ COBRA letters, single carburetor
S1MS-9600-A

List
\$134.95 EA



64-73: Oval shape w/out logo, single carburetor
S1MS-9600-P

List
\$94.95 EA



64-66: 6 cyl. w/ open emissions
CSZZ-9600-A

List
\$105.95 EA



65-66: 6 cyl. closed emissions
CSZZ-9600-B

List
\$109.95 EA



66-67: Stock, 260 & 289, closed emissions
CSZZ-9600-Y

List
\$229.95 EA



65-67: Stock, 260 & 289 open emissions
CSZZ-9600-Z

List
\$239.95 EA

RAM AIR CLEANER BOX



Air cleaner body and lid only. Rubber Hood Seal available under part # D1ZZ-9624

Year	Description	Part No.	List
71-73	V8 Ram Air	D1ZZ-9600-BOX	\$234.95 EA

AIR CLEANER ELEMENT

Quality air filters designed to meet or exceed the specs of the original factory filter.



64-74: High performance, concours
B7SZ-9601-A

List
\$18.95 EA



64-74: Economy
B7SZ-9601-R

List
\$9.95 EA



64-73: Oval shape, reproduction
S1MS-9601-A

List

\$21.95^{EA}

AIR CLEANER LID GASKET



New sponge rubber seal which adheres to the inside top of the air cleaner lid.

Year	Description	Part No.	List
64-73	6 cyl.	C4DZ-9673	\$5.95 ^{EA}
65-67	289, 302	C5ZZ-9673	\$5.95 ^{EA}
68-73	289, 302, 351 and '67 390	C8ZZ-9673	\$5.95 ^{EA}
71-73	351, 429 Ram Air	D1ZZ-9624	\$98.95 ^{EA}

AIR CLEANER DECALS



Identical to the factory decal that designated engine and carburetor size as well as service instructions.

Year	Description	Part No.	List
64	260 CID	DF-45	\$3.50 ^{EA}
64-65	Service	DF-83	\$3.95 ^{EA}
64-66	Vent	DF-350	\$3.95 ^{EA}
64-67	289 High Performance	DF-15	\$3.95 ^{EA}
64-68	Air cleaner, V8	DF-160	\$3.95 ^{EA}
64-68	Air cleaner, 6 cyl.	DF-352	\$3.95 ^{EA}
64-73	Front	DF-150	\$3.00 ^{EA}
65	170 CID	DF-95	\$3.95 ^{EA}
65-66	289-2V	DF-13	\$3.95 ^{EA}
65-66	289-4V	DF-14	\$3.95 ^{EA}
65-68	200 CID	DF-59	\$3.95 ^{EA}
65-70	Ventra Flow	DF-477	\$5.95 ^{EA}
66	200 CID Sprint	DF-171	\$3.95 ^{EA}
66	Part Number	DF-37	\$3.00 ^{EA}
66-73	Service	DF-149	\$3.00 ^{EA}
67	Cobra	DF-744	\$3.95 ^{EA}
67	Part Number	DF-261	\$3.00 ^{EA}
67-68	289-2V	DF-104	\$3.95 ^{EA}
67-68	289-4V	DF-105	\$3.95 ^{EA}
67-68	390 High Performance	DF-322	\$4.95 ^{EA}
67-68	Sports Sprint	DF-246	\$3.95 ^{EA}
67-69	390 CID	DF-53	\$3.95 ^{EA}
67-69	390 4V, premium fuel	DF-54	\$3.95 ^{EA}
68	428-4V, premium fuel	DF-221	\$3.95 ^{EA}
68	427-4V, premium fuel	DF-316	\$3.95 ^{EA}
68	427 4V High Performance	DF-324	\$3.95 ^{EA}
68-69	302 High Performance	DF-321	\$3.95 ^{EA}
68-69	250 CID	DF-443	\$3.95 ^{EA}
68-69	302-2V	DF-60	\$3.95 ^{EA}
68-69	302-4V, premium fuel	DF-61	\$3.95 ^{EA}
69	351-2V	DF-62	\$3.95 ^{EA}
69	351-4V, premium fuel	DF-63	\$3.95 ^{EA}
69	428	DF-778	\$3.95 ^{EA}
69	Boss 302	DF-162	\$3.95 ^{EA}
69-70	Cobra Jet Ram Air	DF-178	\$3.95 ^{EA}
69-70	351 Ram Air	DF-179	\$3.95 ^{EA}
70	250 CID	DF-172	\$3.95 ^{EA}

Year	Description	Part No.	List
70-71	302 2V, regular fuel	DF-182	\$3.95 ^{EA}
70-71	302-4V, premium fuel	DF-183	\$3.95 ^{EA}
70-71	351-2V, regular fuel	DF-184	\$3.95 ^{EA}
70-71	351-4V, premium fuel	DF-185	\$3.95 ^{EA}
70-71	390-4V, premium fuel	DF-479	\$3.95 ^{EA}
71	429-4V, regular fuel	DF-181	\$3.95 ^{EA}
71	Boss 351	DF-260	\$3.95 ^{EA}
71	429 Cobra Jet	DF-395	\$3.95 ^{EA}
71	429-4V, premium fuel	DF-451	\$3.95 ^{EA}
71-73	351-2V, regular fuel	DF-668	\$3.95 ^{EA}
72	351 Cobra Jet	DF-365	\$3.95 ^{EA}
72	351 H0	DF-553	\$3.95 ^{EA}
72-73	250 1V	DF-643	\$3.95 ^{EA}
72-73	302-2V, regular fuel	DF-584	\$3.95 ^{EA}
72-73	302-4V, premium fuel	DF-254	\$3.95 ^{EA}
72-73	351-2V, regular fuel	DF-255	\$3.95 ^{EA}
72-73	351-4V, regular fuel	DF-256	\$3.95 ^{EA}

AIR CLEANER WING NUT



A nice reproduction.

Year	Description	Part No.	List
64-73	1/4-20 thread wing nut	358871-S	\$1.50 ^{EA}
64-68	6 cyl. w/ stud	383132-S	\$1.95 ^{EA}

BILLET AIR CLEANER KNOB

Here's another nice billet product from Scott Drake. Our air cleaner knob matches our billet radiator cap B-8100 and our billet master cylinder cap B-2162-A. All are beautifully machined and have a soft etched finish. Available with or without the screw hole drilled through. 1/4" x 20 threads.



B-358871-A
64-73: solid

List

\$9.95^{EA}



B-358871-B
64-73: w/ hole

List

\$9.95^{EA}

AIR CLEANER TO SNORKLE NUT



Attaches snorkle to air cleaner. Zinc plated.

Year	Part No.	List
64-67	358462-S7	\$3.75 ^{PR}

AIR CLEANER TO CARBURETOR STUD



This screw seems to always be missing. We made our screw just a little longer than stock to allow installing

the Hi-Po air cleaner. Fit most Autolite 4V carburetors assembly. Zinc plated for Part No.s of service. Does not fit Holley or Motorcraft carb.

Year	Description	Part No.	List
64-67	4V 4 1/2" stud, 1/4" x 20 carb threads	37005-S	\$299.95 ^{EA}
64-68	2V 4 1/8" stud, 5/16" x 18 carb threads	37005-S	\$299.95 ^{EA}

HOOD PLENUM



This is the device that channels the air from the hood scoops to the air cleaner on 1971 through 1973 Mustangs.

Year	Part No.	List
71-73	D1ZZ-16613-A	\$249.95 ^{EA}

SHAKER AIR CLEANER ASSEMBLY



Fiberglass construction. Features metal air cleaner lid, shaker air cleaner seal and authentic decal. Filter included. See sheet metal section for hood trim ring. C9ZZ-9600-BB is more than a 1/2" shorter to allow more hood clearance and will fit small blocks with aftermarket intakes. Neither version includes a flapper plate.

Year	Description	Part No.	List
69-70	B302, 351W, 390, 428	C9ZZ-9600-BB	\$529.95 ^{EA}
69-70	302, 351C	C9ZZ-9600-S	\$529.95 ^{EA}

SHAKER HOOD SCOOP KIT



All metal construction just like originals. Includes Intermediate Plate, Flapper with Pivot Rod, Vacuum Actuator, Alloy Hood

Scoop, Spacer Plate and Rubber Hood Seal. C9ZZ-9600-C Pictured.

Year	Description	Part No.	List
69-70	W/Flapper & vacuum actuator	C9ZZ-9600-C	\$699.95 ^{KI}
69-70	W/O Flapper & vacuum actuator	C9ZZ-9600-D	\$659.95 ^{KI}

WE PROUDLY FEATURE AUTHENTIC MUSTANG REPRODUCTIONS FROM SCOTT DRAKE!



Engine

BIG BLOCK METAL SHAKER BASE

Scott Drake is proud to announce their new Big Block Shaker Bases. Made from stamped steel just like the originals choose from the concours correct 1969 428 Cobra Jet or if you are just looking for a quality metal shaker Base for your 1969-1970 390 or 428 we offer our Economy base which is identical but missing the support stud, vent tube, and does not have snorkel hole opening. Note not all aftermarket intake manifolds position the carburetor in the exact same spot as factory intakes.



Year	Description	Part No.	List
69-70	390-428 R-Code Concours	C9ZZ-9600-F	\$549 ⁹⁵ EA

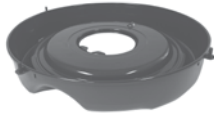

Year	Description	Part No.	List
69-70	390-428 Not Concours	C9ZZ-9600-BBMSB	\$374 ⁹⁵ EA



Year	Description	Part No.	List
69	428CJ Q-Code w/o shaker	C9ZZ-9600-H	\$474 ⁹⁵ EA

SHAKER TOP SCOOP



Die cast alloy like original. Originally used on the Mach 1 and Boss 302.

Year	Description	Part No.	List
69-70	Alloy	C9ZF-9B634	\$299 ⁹⁵ EA

SHAKER INTERMEDIATE PLATE

Stamped from Steel like originals. Depending on engine size minor modification may be required to make work.



69-70: With flapper & vacuum actuator
C9ZZ-9D612

List
\$374⁹⁵ EA



69-70: Without flapper & vacuum actuator
C9ZZ-9600-IP

List
\$239⁹⁵ EA

SHAKER VACUUM MOTOR



Replacement vacuum motor

Year	Part No.	List
69-70	C9ZZ-9600-SVM	\$99 ⁹⁵ EA

SHAKER SCOOP SPACER PLATE

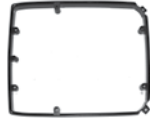

This plate attaches Hood Scoop to the Intermediate Plate. Die-cast zinc.

Year	Part No.	List
69-70	C9ZZ-9B634-P	\$149 ⁹⁵ EA

SHAKER AIR CLEANER SEAL



This rubber seal fits under the shaker intake to help seal around the hood opening.

Year	Description	Part No.	List
69-70	Original Ford	C9ZZ-9B624	\$69 ⁹⁵ EA
69-70	Reproduction	C9ZZ-9B624-C	\$54 ⁹⁵ EA

SHAKER AIR CLEANER BRACKET



Exact reproductions that support scoop to air-cleaner base plate

Year	Description	Part No.	List
70	Boss 302	DOZZ-9A627-A	\$18 ⁹⁵ EA
70	351 Cleveland	DOZZ-9A627-B	\$24 ⁹⁵ PR
69-70	428 Cobra Jet	DOZZ-9A627-C	\$18 ⁹⁵ EA

SHAKER FLAPPER PIVOT ROD



The rod that controls the flapper plate.

Year	Description	Part No.	List
69-70	W/ clips	C9ZZ-9600-PR	\$19 ⁹⁵ EA

SHAKER FLAPPER PLATE



Controls air flow to carburetor.

Year	Description	Part No.	List
69-70	Stamped steel	C9ZZ-9600-FL	\$36 ⁹⁵ EA

SHOW QUALITY ENGINE DRESS UP

KIT



Correct, original-style air cleaner with concours correct valve covers. Includes

concours chrome oil cap. PCV grommet not included, order part# 382156-S. Fits 260-289-302.

Year	Part No.	List
64-73	C5ZZ-6980	\$70 ⁹⁵ KI

ORIGINAL STYLE HIPO CHROME VALVE COVERS



Another classic valve cover by Scott Drake. High quality chrome and improved fit. Will look

great on any small block ford engine. Original equipment on 64-66 289 HiPo "K" engines.

Year	Part No.	List
64-67	C5ZZ-6A582-C/D	\$69 ⁹⁵ PR



The latest addition to our extensive line of valve covers. We have produced these valve covers

from Ford factory specifications. They are absolutely perfect reproductions. Features a beautiful chrome finish and "Power by Ford" stamped on the top.



Year	Part No.	List
68-70	C80Z-6A582-C	\$99 ⁹⁵ PR

ORIGINAL STYLE VALVE COVERS

Quality valve covers with a variety of finishes and styles. See "Hardware" section for valve cover bolts.



64-73: Cal Custom Aluminum-finned, small block
C5ZZ-6A582-AF

List
\$89⁹⁵ PR



65-68: Ford blue, fits 260-289-302-351W
C5ZZ-6A582-BL

List
\$49⁹⁵ PR



64-65: Ford gold, fits 260-289
C5ZZ-6A582-G

List
\$49⁹⁵ PR



68-70: Power By Ford, Ford blue, Fits 260-289-302-351W C80Z-6A582-BL



List
\$59.⁹⁵ PR



67-70: Power by Ford, chrome, concours, fits 390-428 C60Z-6A582-C



List
\$209.⁹⁵ PR

CLASSIC ALUMINUM VALVE COVERS



Made by Scott Drake, Classic Aluminum Valve Covers for small block Ford engines! These valve covers are die-cast from high-quality 383-3 aluminum alloy, & then given a durable powder-coated wrinkled finish or polished aluminum finish. They also feature a cadmium plated oil filler tube to help stop corrosion, an improved oil baffle design to accommodate high-lift cam shafts, & will work with most roller rockers. Spark plug wire brackets & PCV grommet included. Available in a variety of styles. Will not fit EFI cars. Note: "COBRA" (S1MS-6A582-P version will not clear roller rockers.

Year	Description	Part No.	List
64-73	"289", Black	6A582-289*	\$149. ⁹⁵ PR
64-73	"289", Polished	6A582-289P*	\$199. ⁹⁵ PR
64-73	"302", Black	6A582-302*	\$149. ⁹⁵ PR
64-73	"302", Polished	6A582-302P*	\$199. ⁹⁵ PR
64-73	"351", Black	6A582-351*	\$149. ⁹⁵ PR
64-73	"351", Polished	6A582-351P*	\$199. ⁹⁵ PR
64-73	"Shelby", Black	6A582-S ⁵	\$169. ⁹⁵ PR
64-73	"Shelby", Polished	6A582-SP ⁵	\$204. ⁹⁵ PR
64-73	"Bronco", Black	6A582-B*	\$149. ⁹⁵ PR
64-73	"Bronco", Polished	6A582-BP*	\$204. ⁹⁵ PR
64-73	"Ranchero", Black	6A582-R*	\$149. ⁹⁵ PR
64-73	"Falcon", Black	6A582-F*	\$149. ⁹⁵ PR
64-73	"Fairlane", Black	6A582-FL*	\$149. ⁹⁵ PR
64-73	"Comet", Black	6A582-CT	\$149. ⁹⁵ PR
64-73	"Comet", Polished	6A582-CTP*	\$204. ⁹⁵ PR
64-73	"Mustang", Block letters;	C5ZZ-6A582-A/B*	\$169. ⁹⁵ PR

Year	Description	Part No.	List
64-73	"Mustang" Block polished	C5ZZ-6A582-A/BP	\$209. ⁹⁵ PR
64-73	"Mustang", Script	6A582-MH	\$169. ⁹⁵ PR
64-73	"Mustang", Script polished	6A582-MHP	\$209. ⁹⁵ PR
64-73	"Cobra", Block (solid letters)	S2MS-6A582-A/B*	\$169. ⁹⁵ PR
64-73	"Cobra", Polished (solid letters)	S2MS-6A582-A/BP	\$209. ⁹⁵ PR
64-73	"Cobra", Polished fins (open letters)	S1MS-6A582-P*	\$249. ⁹⁵ PR
64-73	"Cobra", Block (open letters)	6A582-C	\$169. ⁹⁵
64-73	Cobra", Polished (open letters)	6A582-CP	209. ⁹⁵ PR
64-73	"Cougar", Black	6A582-CO*	\$239. ⁹⁵ PR
64-73	"Cougar", Polished	6A582-COP*	\$289. ⁹⁵ PR

ECONOMY ENGINE DRESS UP KIT



This is an economical way to dress up your Mustang small block engine or any small block Ford.

Brightens engine compartment for a cleaner look. These kits are pre-packaged, sorry no substitutions. Includes one C5ZZ-9600-W air cleaner with 289 HiPo decal, one pair W89248B valve covers, one W84881B oil cap, one W84889B oil cap grommet and one W89771B PCV grommet. Fits 260-289-302

Year	Part No.	List
64-73	C5ZZ-6980	\$70. ⁹⁵ KI

AFTERMARKET CHROME VALVE COVER



Quality valve covers available at a great price.

Year	Description	Part No.	List
64-73	Fits 6 cyl. 170-200-250	C4DZ-6A582-C	\$31. ⁹⁵ EA
64-66	Fits 260-289-302-351	C5ZZ-6A582-C	\$35. ⁹⁵ PR
67-70	Fits 390-427-428	C7ZZ-6A582-C	\$34. ⁹⁵ PR
70-73	Fits 351C	DOZZ-6A582-C	\$41. ⁹⁵ PR

VALVE COVER GASKET



Valve cover gaskets, made by Fel-Pro.

Year	Description	Part No.	List
64-73	6 cyl.	CODE-6584-BR	\$18. ⁹⁵ EA
62-77	Small block, cork	C20Z-6584-AC	\$18. ⁹⁵ PR
64-73	Small block, rubber	C20Z-6584-AR	\$20. ⁹⁵ PR
67-70	Big block, cork	C7ZZ-6584-DC	\$24. ⁹⁵ PR
67-70	Big block, rubber	C7ZZ-6584-DR	\$26. ⁹⁵ PR
70-73	351 Cleveland, cork	DOZZ-6584-CC	\$24. ⁹⁵ PR
70-73	351 Cleveland, rubber	DOZZ-6584-CR	\$28. ⁹⁵ PR

VALVE COVER GROMMET



65-67: 1" opening, Aluminum valve covers C5ZZ-6A892-A

List
\$3.⁹⁵ EA



67-69: Original factory specs, Perfect fit for C80Z-6A582-C C6AZ-6892-A

List
\$3.⁹⁵ EA



1964-67 Mustang PCV grommet 3/4" ID 1" OD 382156-S

List
\$2.⁹⁵ EA



64-68: For original style, stamped-steel valve covers 5/8" ID 1" OD C8AZ-6892

List
\$3.⁹⁵ EA



65-73: Round w/ notches, aluminum VC C7AZ-6892

List
\$5.⁹⁹ EA



64-73: Pair, Ford motorsport. C5ZZ-6A892-FMS

List
\$9.⁹⁵ EA



70-71: For original style, stamped steel valve covers D00Z-6892

List
\$3.⁹⁵ EA



64-73: Oil cap, 1" inside diameter, works on our chrome aftermarket valve covers W84889B

List
\$1.⁹⁵ EA



64-73: Oil cap, 3/4" inside diameter, works on our chrome aftermarket valve covers W89771B

List
\$1.⁹⁵ EA

WE PROUDLY FEATURE AUTHENTIC MUSTANG REPRODUCTIONS FROM SCOTT DRAKE!



OIL CAPS

OIL CAP

Scott Drake offers the largest selection of concours correct Oil Caps. Our caps fit perfect, function just like the originals, and are worthy of any show car. Original Ford logos and markings included where necessary.



64-68: FoMoCo logo, closed, push-on
B6AZ-6766-B



List
\$16.95 EA



64-68: Motorcraft, chrome, twist-on, service replacement, not concours
C3AZ-6766-E

List
\$19.95 EA



65-70: FoMoCo logo, black, w/ tube, push-on
C5Z-6766-B



List
\$18.95 EA



65-67: FoMoCo logo, chrome, twist-on, no emissions control, concurs for early 390 but also works on late 390-428 and SB
C80Z-6A582-C
Valve covers #
C5ME-6766-A



List
\$34.95 EA



65-66: FoMoCo logo, Chrome, w/ tube, push-on
C5Z-6766-D



List
\$24.95 EA



65-67: FoMoCo logo, Shelby, chrome, push-on
C5Z-6766-E



List
\$34.95 EA



65-70: Chrome and decal, push-on
C5Z-6766-F



List
\$19.95 EA



64-66: Black, no tube, open, push-on
C5Z-6766-FR



List
\$14.95 EA



64-66: Black, closed w/ elbow, push-on
C5Z-6766-HR

List
\$19.95 EA



64-66: Chrome, closed w/ elbow, push-on
C5Z-6766-IR

List
\$22.95 EA



67-70: Autolite Logo, black, closed, twist-on
C8AZ-6766-A



List
\$29.95 EA



67-70: Autolite Logo, chrome, closed, twist-on
C8AZ-6766-B



List
\$39.95 EA



68-70: No logo, Chrome, closed, twist-on
C8AZ-6766-BR

List
\$34.95 SE



68-69: Autolite logo, Chrome, Gold Metal, PCV Elbow, Concours
C8AZ-6766-BC



List
\$49.95 SE



71-73: Painted black, twist on, Autolite logo
D1AZ-6766-A

List
\$29.95 EA



71-73: Chrome, twist on, Autolite logo
D1AZ-6766-C

List
\$34.95 EA

AFTERMARKET OIL CAP

Brightens the engine compartment and looks sharp. Fits our aftermarket valve covers only.



64-73: Chrome, push on, no tube
W84881B

List
\$5.95 EA

AFTERMARKET OIL CAP (CONTINUED)



64-73: Chrome w/"OIL" letters, push on
W89181B

List
\$5.95 EA



64-73: Chrome, push on, w/ tube
W89252B

List
\$5.95 EA

BILLET ENGINE CAPS & HANDLES



Made by Scott Drake, these caps and handles are beautifully machined from solid billet aluminum. Our caps feature a stamped aluminum insert with carbon-fiber-look design. Our handles feature original style dipsticks. A quick and easy way to add a custom look to your Mustang's engine compartment!

Year	Description	Part No.	List
65-73	Radiator cap	B-8100	\$35.95 EA
65-68	Oil cap, push-on	B-6766-A	\$34.95 EA
65-66	Power steering cap cover, w/ out stick	B-3A006-A	\$29.95 EA
65-66	Power steering cap, w/ stick	B-3A006-B	\$29.95 EA
Year	Description	Part No.	List
67-70	Power steering handle, w/ stick	B-3A006-C	\$32.95 EA
65-73	Oil Dipstick handle, w/ stick (289)	B-6750	\$32.95 EA
65-73	Trans Dipstick handle, w/ stick (C-4)	B-7A020	\$32.95 EA

OIL CAP PCV ELBOW



Precision machined to the factory specifications. Light gold anodized finish just like the original. Perfect for our C8AZ-6766-A or -B oil caps.

Year	Part No.	List
67-70	C8AZ-6767-A	\$12.95 EA

OIL CAP ADAPTER



This adapter allows push-on type oil caps to be used on valve covers with twist-on type oil cap hole.

Year	Part No.	List
64-73	CSAZ-6A868-A	\$9.95 EA

PCV FITTING



Exact detail. Gold dichromate finish.

Year	Description	Part No.	List
67-70	Big block	C70Z-6A706-A	\$29.95 ^{EA}

OIL CAP TO AIR CLEANER HOSE



Correct hose to connect the oil cap breather to the air cleaner. Features oval FoMoCo logo. Cut to fit. Requires

2 C3AZ-18572-A Hose Clamps.



Year	Description	Part No.	List
65-66	Cut to fit	C4AE-6853-B	\$11.95 ^{EA}

PCV HOSE



Concours correct with ink stamped FoMoCo script. Connects PCV valve to carburetor spacer plate. Requires 2 C3AZ-18572-A Hose Clamps.



Year	Description	Part No.	List
65-68	Small block	C6AZ-6A664-N	\$10.95 ^{EA}
68-70	Big block	C8AZ-6A664-D	\$26.95 ^{EA}
69-70	351W	C90Z-6A664-A	\$19.95 ^{EA}
70-73	351 Cleveland	DOAZ-6A664-C	\$16.95 ^{EA}

ALTERNATOR COMPONENTS

GENERATOR BELT



All belts are constructed by the original manufacturer and made in the U.S.A. Each belt is concours

correct with all the authentic inked markings. All belts are approved by Mustang Club of America and are recognized as concours correct.



Year	Description	Part No.	List
64	High performance w/ generator	C20E-8620-AC	\$24.95 ^{EA}
64	Small block w/ generator	C4SE-8620-C	\$24.95 ^{EA}

ALTERNATOR BELT



All belts are constructed by the original manufacturer and made in the U.S.A. Each belt is

concours correct with all the authentic inked markings. All belts are approved by Mustang Club of America and are concours correct.



Year	Description	Part No.	List
65	200 w/out AC	C5DE-8620-D	\$23.75 ^{EA}
65-67	289 High performance	C50E-8620-K	\$23.75 ^{EA}
65-69	260, 289, 302, 66-67 w/out AC	C4TE-8620-S	\$23.75 ^{EA}
66-67	289 w/ AC	C4AE-8620-A	\$23.75 ^{EA}
66-70	200 w/out AC	C5DE-8620-C	\$23.75 ^{EA}
67	390, 428 w/out AC	C4AE-8620-D	\$23.75 ^{EA}
68-69	390 GT, 428CJ w/out AC	C6AE-8620-L	\$23.75 ^{EA}
69-70	428CJ w/out AC	C4AE-8620-H	\$23.75 ^{EA}
70	302 Boss, w/ power steering	DOZE-8620-E	\$23.75 ^{EA}
70	Boss 302, 351, 351C w/o power steering	DOZE-8620-F	\$23.75 ^{EA}
70-71	302, 351C w/ power steering or AC	C4AE-8620-B	\$23.75 ^{EA}

ALTERNATOR BRACKET



OEM style brackets. Available in bright chrome or black.



Year	Description	Part No.	List
65-73	Small block, black	C5ZZ-10145/51BK	\$14.95 ^{SE}
65-73	Small block, chrome	C5ZZ-10145/51-K	\$14.95 ^{SE}

ALTERNATOR BRACKET



351 Windsor upper head bracket.



Year	Description	Part No.	List
69	351 Windsor, upper head bracket	C9ZZ-10145-A	\$36.95 ^{EA}

CONCOURS ALTERNATOR BRACKETS



These lower alternator brackets are concours correct. They feature all original markings including Ford Part Number, Manufacturer's

Logo and FoMoCo stamp where required. These are also the correct thickness per Ford Blueprints and original samples

Year	Description	Part No.	List
65-67	289 / Late 65-67	C50Z-10156-A	\$11.95 ^{EA}
68-69	289-302	C80Z-10156-A	\$11.95 ^{EA}



These upper alternator brackets are concours correct. They feature all original markings including Ford Part Number, Manufacturer's

Logo and FoMoCo stamp where required. These are also the correct thickness per Ford Blueprints and original samples



Year	Description	Part No.	List
65-67	289	C5AZ-10145-A	\$12.95 ^{EA}
68-69	289-302	C70Z-10145-A	\$12.95 ^{EA}

ALTERNATOR FAN



Made from original dies. Plated gold zinc dichromate.

Year	Description	Part No.	List
65-69	Gold zinc dichromate	C5AZ-10A310-B	\$12.00 ^{EA}

ALTERNATOR FAN AND PULLEY KIT



Chrome alternator pulley and fan. Includes lockwasher and nut.

Year	Description	Part No.	List
65-73	Chrome, 4 piece kit	C5ZZ-10A310/44C	\$17.95 ^{SE}

ALTERNATOR MOUNTING KIT



Concours correct mounting hardware. Cadmium plated with correct "F" marking. Spacer not included.

Year	Description	Part No.	List
65-67	289, 302, 390 and 428	C5DZ-10346-MK	\$9.95 ^{KI}
67-70	390 and 428	C7ZZ-10346-MK	\$9.95 ^{KI}
68-69	289 and 302 w/out smog	C8ZZ-10346-MK	\$9.95 ^{EA}

WE PROUDLY FEATURE AUTHENTIC MUSTANG REPRODUCTIONS FROM SCOTT DRAKE!



ALTERNATOR PULLEY

Made by Scott Drake from the original Ford print. Features part number stamped in to the face of the pulley just like the original.



C5AZ-10344-K
65-73: Single

Year	Description	Part No.	List
65-73	Single	C5AZ-10344-K	\$24.00 ^{EA}



C5AZ-10344-L
65-73: Dual

Year	Description	Part No.	List
65-73	Dual	C5AZ-10344-L	\$27.95 ^{EA}

HI PO ALTERNATOR PULLEY



Made by Scott Drake from the original Ford print. Features part number stamped in to the face of the pulley just like the

original. Large diameter pulley was original equipment on 289 HiPo's and Boss 302's. Prevents damage to alternator.

Year	Description	Part No.	List
65-73	Black steel	C5AF-10A352-C	\$39.95 ^{EA}
65-73	Yellow steel	C5AF-10A352-H	\$39.95 ^{EA}
64-73	Chrome	C5AF-10A352-S	\$39.95 ^{EA}

ALTERNATOR PULLEY LOCK NUT & WASHER



Concours correct mounting hardware.

Year	Description	Part No.	List
64-73	Gold	CSDZ-10346-NG	\$4.00 ^{SE}
65-73	Silver	CSDZ-10346-NS	\$4.00 ^{SE}

ALTERNATOR SPACER



This spacer is made from extruded aluminum and anodized the correct color.

Year	Description	Part No.	List
64-69	289 & 302, Gold	C5AE-10A370-A	\$9.95 ^{EA}
66-70	390 & 428, Pink	C5AE-10A370-B	\$9.95 ^{EA}
70-73	351C, Silver	DOOF-10A370-A	\$9.95 ^{EA}

CYLINDER HEAD COMPONENTS

HEAD GASKET



These are the highest quality U.S. made gaskets. Made by FELPRO®.

Year	Description	Part No.	List
64-73	Small block	C3AZ-6051-C/G	\$29.95 ^{EA}
64-70	6 cyl.	C30Z-6051-A	\$49.95 ^{EA}
70-73	351 Cleveland	D0ZZ-6051-C	\$- ^{EA}

HEAD GASKET KIT



This set includes head gaskets, intake manifold, exhaust manifold, carb, base plate, water inlet, valve cover, valve stem seals. Made by FELPRO®.

Year	Description	Part No.	List
64-73	Small block	C3AZ-6051-C/GK	\$109.95 ^{KI}
64-70	6 cyl.	C30Z-6051-AK	\$84.95 ^{KI}

FULL ENGINE GASKET KIT



Our most complete quality Fel-Pro gaskets set. Includes the following: Head gaskets, exhaust gaskets, exhaust flanges, valve stem seals, water outlet, carb base plate, oil pan, fuel pump, timing chain cover and water pump gaskets.

Year	Description	Part No.	List
64-70	6 cyl.	FS-7916PT2	\$129.95 ^{SE}
70-73	351 Cleveland	FS-8347PT	\$109.95 ^{KI}
64-73	Small block	FS-8548PT16	\$187.95 ^{KI}
67-70	Big block	FS-8554PT	\$169.95 ^{KI}

DISTRIBUTOR

IGNITOR CONVERSION



Never change points again, plus increase horsepower and improve fuel economy. Fits entirely under the distributor cap, with no "black box" to clutter the engine compartment. Installs in minutes, and is completely hidden. Other benefits: Test results show the Ignitor delivers twice the voltage to the spark plugs. No limits to coil and spark energy (spark energy is limited by the coil). A 2:1 improvement over "point type" systems in current fall time. Stable timing with no need for periodic adjustments. Increase spark plug life by 2 to 3 times. No contacts to burn, pit and corrode. No moving and rubbing parts to wear out. Better foul weather performance.

Year	Description	Part No.	List
64-73	6 cyl.	IGN-1261	\$97.95 ^{KI}
64-67	6 cyl. Pertronix	IGN-1266	\$97.95 ^{KI}
64-73	V8	IGN-1281	\$97.95 ^{KI}
64-72	V8, dual point	IGN-1281-D	\$97.95 ^{KI}
64-72	V8, dual point w/ vacuum advance	IGN-1281-DV	\$98.95 ^{KI}
64-73	High power 6 cyl.	IGN-1261-2	\$129.95 ^{EA}
64-73	High power V8	IGN-1281-2	\$129.95 ^{EA}

HIGH POWER IGNITOR CONVERSION



The Ignitor II takes the Ignitor a step further by adding a powerful new microcontroller, that controls the dwell

period, for the best possible spark over the entire RPM range. Ignitor II offers enhanced performance levels only found in more expensive box type ignition systems. Compared to point type systems Ignitor II develops on average 4 times more available energy between 3,000 and 5,000 RPM, and 2 times more available plug voltage. Higher RPM performance is improved when used with the Flame-Thrower II super low resistance 45,000 volt coil

Year	Description	Part No.	List
64-73	High power 6 cyl.	IGN-1261-2	\$129.95 ^{EA}
64-73	High power V8	IGN-1281-2	\$129.95 ^{EA}

COIL



These replacement "yellowtop" ignition coils are copies of the original Ford part used between 1964 - 1968.

Year	Description	Part No.	List
64-73	Yellow top (20,000 volts)	B6A-12029-B	\$52.95 ^{EA}

Stock to super high power, we have a coil for your needs. Pertronix, high power, chrome (45,000 volts) is only for use with high-power kits



Year	Description	Part No.	List
64-73	Pertronix, chrome (40,000 volts)	IGN-40001	\$43.95 ^{EA}
64-73	Pertronix, high power, chrome (45,000 volts)	IGN-40001-2	\$49.95 ^{EA}

Stock to super high power, we have a coil for your needs. Pertronix, high power, black (45,000 volts) is only for use with high-power kits



Year	Description	Part No.	List
64-73	Pertronix, black (40,000 volts)	IGN-40011	\$38.95 ^{EA}
64-73	Pertronix, high power, black (45,000 volts)	IGN-40011-2	\$46.95 ^{EA}

SHOP WITH CONFIDENCE! WE OFFER SUPERIOR-QUALITY PARTS FOR ALL YOUR MUSTANG RESTORATION NEEDS.

COIL BRACKET



We made our concours bracket capable of holding the smaller coils on the market today as well the original coils. Zinc plated hex head bolt and nut included. Our bracket is also available in polished stainless steel. Chrome version is a universal bracket that does not resemble original.

nut included. Our bracket is also available in polished stainless steel. Chrome version is a universal bracket that does not resemble original.

Year	Description	Part No.	List
64-73	Black	C4DZ-12043-A	\$12.95 ^{EA}
64-73	Stainless polished	C4DZ-12043-S	\$16.95 ^{EA}
64-73	Chrome, universal	IGN-10002	\$12.95 ^{EA}

BILLET PERTRONIX DISTRIBUTOR



Designed to provide maximum ignition performance and easy installation at an affordable price. Now you

can upgrade your outdated points or stock electronic distributor with a performance proven distributor that features the patented Ignitor II module and a CNC machined 6061 T-6 polished billet housing and deck. Comes with a factory configured performance curve with additional spring sets for custom curving.



Year	Description	Part No.	List
64-73	W/ vacuum	IGN-1307	\$294.95 ^{EA}

HEI DISTRIBUTOR



Designed for the enthusiast looking for a simple and dependable high energy distributor. Drop in and connect two wires. it's

that simple. features 50,000 volt HEI coil that delivers twice the energy across the spark gap compared to a stock HEI distributor.

Year	Description	Part No.	List
63-84	Street or strip	IGN-D1352	\$94.95 ^{EA}

PERTRONIX DISTRIBUTOR



Now available by Drake, this stock appearing Distributor is the ultimate for the sleeper look. It features a brand new

casting along with all new components including a maintenance free solid state Ignitor, adjustable optimum performance and drive-ability plus a new High Dielectric strength cap with brass contacts cap and a rotor. Very affordable performance Distributor without the aftermarket look which some customers wish to avoid. Year 260, 289, and 302 engines. Does not fit 351 engines. Cars with Roller Cam option may need to change out drive gear.



Year	Description	Part No.	List
64-73	260, 289, and 302 Engines	IGN-D134600	\$204.95 ^{EA}

DISTRIBUTOR CAP



V8 version has Brass contacts-Exact copy of original cap.

Year	Description	Part No.	List
55-72	6 cyl., Motorcraft	7HA-12106-A	\$29.95 ^{EA}
55-74	V8, Brass	B7A-12106-A	\$10.95 ^{EA}
58-74	Autolite logo	B7A-12106-AR	\$29.95 ^{EA}

DISTRIBUTOR CLAMP



Features flawless chrome finish and chrome mounting bolt. Will work for most Ford & Lincoln-Mercury applications.

Year	Description	Part No.	List
64-73	Small Block	C5ZZ-12270	\$5.95 ^{EA}

DISTRIBUTOR TUNE UP KIT



Our tune-up kits have all the required replacement parts. Included in each kit are: rotor, condenser and points.

Year	Description	Part No.	List
64-73	260, 289, 302, 351, 390	COTZ-12000-A	\$23.95 ^{KI}

DISTRIBUTOR TUNE UP KIT



These vacuum advances are made in the U.S.A. by an OEM supplier. Zinc plated to prevent corrosion.

Year	Description	Part No.	List
65-67	6 cyl	DD-12	\$24.95 ^{EA}
65-71	V8	DD-190	\$22.95 ^{EA}
68-71	Dual vacuum	DD-377	\$52.95 ^{EA}

DISTRIBUTOR VACUUM ADVANCE LINES



Quality one piece lines with correct fittings.

Part No.	Year	Description	List
MVL001	64-68	Small block, steel	\$14.95 ^{EA}
MVL001S	64-68	Small block, stainless	\$16.50 ^{EA}
MVL002	66-68	200-6, steel	\$16.00 ^{EA}
MVL002S	66-68	200-6, stainless	\$20.95 ^{EA}
MVL003	64-65	170-6, steel	\$16.00 ^{EA}
MVL003S	64-65	170-6, stainless	\$22.95 ^{EA}

VACUUM LINE HOSE KIT



All vacuum hoses have correct color striping with repeating "MX" markings. Manufactured by original

suppliers. Markings are very durable and don't come off easily.

Year	Description	Part No.	List
68-70	Big block, manual trans	C8ZZ-12226-A	\$19.95 ^{KI}
68-70	Big block, automatic trans	C8ZZ-12226-B	\$19.95 ^{KI}
68-73	Small block, dual diaphragm	C8ZZ-12226-C	\$19.95 ^{KI}
68-73	Small block, single diaphragm	C8ZZ-12226-D	\$19.95 ^{KI}
69-70	Boss 302	C9ZZ-12226-A	\$19.95 ^{KI}
70-73	351 Cleveland w/ dual diaphragm	D0ZZ-12226-A	\$19.95 ^{KI}
71	Boss 351	D1ZZ-12226-A	\$19.95 ^{KI}
71	429 Cobra Jet, manual trans	D1ZZ-12226-B	\$19.95 ^{KI}
71	429 Cobra Jet, automatic trans	D1ZZ-12226-C	\$19.95 ^{KI}
71-73	All Ram Air cars	D1ZZ-12226-D	\$19.95 ^{KI}

WE PROUDLY FEATURE AUTHENTIC MUSTANG REPRODUCTIONS FROM SCOTT DRAKE!



HARMONIC DAMPER



High performance or stock specifications, these quality dampers are made in the USA.

Year	Description	Part No.	List
65-67	200, 6 cyl.	C2DZ-6312-A	\$109 ⁹⁵ EA
64-68	5.0 conversion, 3 bolt w/out lip	C5AZ-6316-5.0	\$149 ⁹⁵ EA
64-68	289, except hi-po	C5AZ-6316-B	\$99 ⁹⁵ EA
63-67	High Performance "K"	C50E-6316-A	\$279 ⁹⁵ EA
68	302, 3 bolt	C8AZ-6316-A	\$129 ⁹⁵ EA
68-74	Big block 390-428	C8AZ-6316-B	\$99 ⁹⁵ EA
69-70	428 SCJ	C8AZ-6316-C	\$299 ⁹⁵ EA
69	302, 3 bolt w/ lip	C90E-6316-D	\$129 ⁹⁵ EA
69	351W, 3 bolt	C90Z-6316-A	\$134 ⁹⁵ EA
70-73	302, 4 bolt	D20Z-6316-A	\$- EA
69	5.0 & 5.8 conversion, 3 bolt, w/ lip	D2TE-6316-5.0	\$174 ⁹⁵ EA

HARMONIC DAMPER SPACER



Correct spacers to fit 80006 & 80007.

Year	Description	Part No.	List
64-79	351W	81006	\$21 ⁹⁵ EA

PERFORMANCE HARMONIC DAMPER



Made from extremely tough nodular iron. Suitable for all street applications and mild racing applications.

Designed for revving as high as 6500 rpm. Features gloss black finish with three sets of white timing marks. 80007 used when installing 1981 or newer 302 in a Classic Mustang.

Year	Description	Part No.	List
64-79	289, 302, 28 oz.	80006	\$114 ⁹⁵ EA
64-73	302 50oz 4-bolt pulley	80007	\$124 ⁹⁵ EA
66-73	390, 428, 50 oz	80009	\$114 ⁹⁵ EA

SPARK PLUG WIRE SEPERATOR

Keeps spark plug wires neat and orderly.



64-73: Attach to wires
B6A-12297-A

List
\$2⁰⁰ EA



64-73: Mounts on valve covers
B8Q-12297-A

List
\$3⁹⁵ EA

SPARK PLUG WIRE SEPERATOR SET



These Spark Plug Wire Separators are made of high-quality ABS plastic. Constructed to hold both standard 7mm and 8mm high-performance spark plug wires. Fits directly on valve cover clip. 4 piece sets.

Year	Description	Part No.	List
64-73	Black	B6AB8Q-12297-KA	\$11 ⁹⁵ SE
64-73	Blue	B6AB8Q-12297-KB	\$13 ⁹⁵ SE
64-73	Red	B6AB8Q-12297-KR	\$13 ⁹⁵ SE

AFTERMARKET SPARK PLUG WIRE SETS



Our aftermarket wire sets are made from premium radio suppression or wire core cables as per factory specifications.

Year	Description	Part No.	List
64-73	Motorcraft, 6 cyl.	C50Z-12259-AMC	\$40 ⁹⁵ EA
64-73	Motorcraft, V8 except 390	C50Z-12259-BMC	\$40 ⁹⁵ EA

CONCOURS SPARK PLUG WIRE SETS



These original type wire sets are made from premium radio suppression core cable. Original appearance and length-matched. Boots are color correct.

Year	Description	Part No.	List
64-66	6 cyl.	C50Z-12259-A	\$44 ⁹⁵ SE
64-66	V8	C50Z-12259-B	\$55 ⁹⁵ SE
65-66	289 High Performance	C50Z-12259-K	\$55 ⁹⁵ SE
66	289 w/ smog	C60Z-12259-A	\$55 ⁹⁵ SE
67	6 cyl.	C70Z-12259-A	\$44 ⁹⁵ SE
67	289 w/out smog	C70Z-12259-B	\$55 ⁹⁵ SE
67	390, 428 w/out smog	C70Z-12259-C	\$55 ⁹⁵ SE
67-68	428 police interceptor, GT500	C70Z-12259-D	\$55 ⁹⁵ SE
67	289 w/ smog	C70Z-12259-F	\$55 ⁹⁵ SE
68-71	289, 302 w/out smog	C80Z-12259-B	\$55 ⁹⁵ SE
68-69	390, 428 w/out smog	C80Z-12259-C	\$55 ⁹⁵ SE
68-70	390, 428 w/ smog	C80Z-12259-D	\$55 ⁹⁵ SE
68	289, 302 w/ smog	C80Z-12259-E	\$55 ⁹⁵ SE
69-70	Boss 302	C90Z-12259-A	\$55 ⁹⁵ SE
69-71	351W	C90Z-12259-B	\$55 ⁹⁵ SE
70-71	351 Cleveland	D0ZZ-12259-A	\$59 ⁹⁵ SE
71	429, 429CJ	D1ZZ-12259-A	\$55 ⁹⁵ SE

PERTRONIX SPARK PLUG WIRE SETS



These low resistance, high performance wire sets feature two current paths. One path is spiral wound stainless steel alloy and

the other is a carbon impregnated fiberglass center core. Other features include low 500 ohm per foot resistance. Silicone jackets used to resist high temperatures, moisture, oil and chemicals. EPDM rubber inner insulation for superior heat resistance and prevention of arching and voltage leaks. Fiberglass reinforcing braid for added strength and flexibility. Available in red, blue and black, these spark plug wires come with a lifetime warranty and are made in the U.S.A.



Year	Description	Part No.	List
64-73	8mm Black	IGN-808280	\$64 ⁹⁵ SE
64-73	8mm Blue	IGN-808380	\$64 ⁹⁵ SE
64-74	8mm Red	IGN-808480	\$64 ⁹⁵ SE

HARDWARE & MOUNTS

ENGINE MASTER FASTENER KIT



These are really great kits. They include exact original equipment hardware. Again these are not off the shelf generic fasteners, but have

been re-tooled and are made identical to the original. Each kit includes hardware to attach the following: valve covers, air cleaner, intake manifold, oil pan, timing cover, water pump, crank pulley, thermostat housing, heat shield, distributor, carburetor, exhaust manifolds, fuel pump, oil filter adapter, engine tag and ignition coil.

Year	Description	Part No.	List
64-65	SB w/ generator, includes exht locks	EMK-C20E-322	\$124 ⁹⁵ KI
64	SB w/ generator & AC	EMK-C20E-336	\$119 ⁹⁵ KI
64	SB HiPo w/ generator & AC	EMK-C30E-323	\$119 ⁹⁵ KI
65	SB 289 w/ alum. water pump & alt	EMK-C50E-559	\$119 ⁹⁵ KI
65	SB 289 w/ AC	EMK-C50E-560	\$119 ⁹⁵ KI
65	SB 289 High Performance w/ alum. water pump & alternator	EMK-C50E-561	\$119 ⁹⁵ KI
65	SB 289 w/ cast iron water pump & alt	EMK-C50E-812	\$119 ⁹⁵ KI
65	SB 289 High Performance w/ cast iron water pump & alternator	EMK-CSZE-1067	\$119 ⁹⁵ KI
66	6 cyl.	EMK-C60E-320	\$94 ⁹⁵ KI
66-67	SB 289 w/ cast iron water pump	EMK-C60E-324	\$119 ⁹⁵ KI

Year	Description	Part No.	List
66-67	SB 289 High Performance w/ cast iron water pump & Ramp-locs	EMK-C60E-325	\$119. ⁹⁵ KI
66	SB 289 w/ cast iron water pump & AC & Ramp-locs	EMK-C60E-337	\$119. ⁹⁵ KI
67	Big block 390 GT	EMK-C70E-330	\$134. ⁹⁵ KI
67	SB 289 w/ AC	EMK-C70E-562	\$119. ⁹⁵ KI
68-70	6 cyl.	EMK-C80E-321	\$94. ⁹⁵ KI
68	SB 289, 302	EMK-C80E-326	\$119. ⁹⁵ KI
68-69	Big block 390 GT	EMK-C80E-332	\$134. ⁹⁵ KI
68	Big block 428 Cobra Jet	EMK-C80E-333	\$134. ⁹⁵ KI
68	SB 289, 302 w/ AC	EMK-C80E-338	\$124. ⁹⁵ KI
69-70	Big block 429 & Boss 429	EMK-C9AE-1182	\$199. ⁹⁵ KI
69-73	6 cyl. 250	EMK-C9DE-342	\$94. ⁹⁵ KI
69	SB 302	EMK-C90E-1126	\$119. ⁹⁵ KI
69-73	SB 302 w/ AC	EMK-C90E-1127	\$119. ⁹⁵ KI
69	SB 351	EMK-C90E-1128	\$119. ⁹⁵ KI
69	SB 351 w/ AC	EMK-C90E-1129	\$119. ⁹⁵ KI
69-70	SB GT-350 w/out AC	EMK-C90E-1188	\$139. ⁹⁵ KI
69-70	Big block 428 Cobra & Super Cobra Jet	EMK-C90E-334	\$134. ⁹⁵ KI
69	SB Boss 302	EMK-C9ZE-1180	\$199. ⁹⁵ KI
69	SB 302	EMK-DO0E-1130	\$119. ⁹⁵ KI
70	SB 351W	EMK-DO0E-1132	\$119. ⁹⁵ KI
70-71	SB 351 Cleveland w/ 2 brl carburetor	EMK-DO0E-1175	\$119. ⁹⁵ KI
70-71	SB 351 Cleveland w/ 4 brl carburetor	EMK-DO0E-1176	\$119. ⁹⁵ KI
71	Boss 351	EMK-DO0E-1177	\$144. ⁹⁵ KI
70	SB Boss 302	EMK-DOZE-1181	\$199. ⁹⁵ KI
72-73	SB 351 Cleveland w/ 2 brl carburetor	EMK-D20E-1178	\$119. ⁹⁵ KI
72-73	SB 351 Cleveland w/ 4 brl carburetor	EMK-D20E-1179	\$119. ⁹⁵ KI
65	SB GT-350	EMK-S1ME-1184	\$139. ⁹⁵ KI
66	SB GT-350	EMK-S2ME-1185	\$139. ⁹⁵ KI
67	SB GT-350	EMK-S7ME-1186	\$139. ⁹⁵ KI
67	Big block GT-500	EMK-S7ME-1186	\$139. ⁹⁵ KI
68	SB GT-350	EMK-S8ME-1187	\$ ₋ KI
68	Big block GT-500KR & 428 Cobra Jet	EMK-S8ME-382	\$169. ⁹⁵ KI
68	Big block GT-500	EMK-S8ME-677	\$169. ⁹⁵ KI

CONCOURS 289 HIPO MOTOR MOUNT KIT

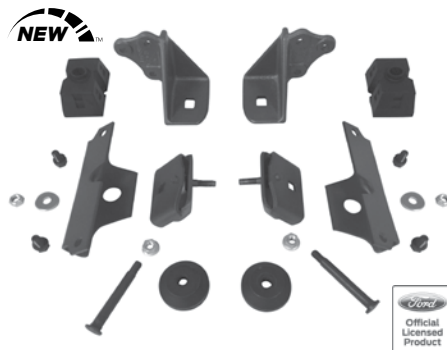

This Complete kit included everything needed for either a 1964-1965 "K code 289 HiPo Mustang or 65 and Early 66 Shelby GT350's. This design is much more stronger than factory 64-66 Mustang Engine Mounts which fail quickly when exposed to excessive Torque and Horsepower. These are exact Copies of the Originals. Includes Lower Cast Frame Brackets with Part Numbers, Intermediate Brackets, Upper Engine Brackets, Main Rubber Mounts, Donut Rubber Isolators and all necessary correct hardware for a trouble free Installation. Originally these Brackets were raw and quickly surface rusted, ours are painted a natural steel color so it will look like new for many years.

Year	Description	Part No.	List
64-65	Complete kit	CSZZ-6028/9-HPK	\$449. ⁹⁵ KI



These Stamped Steel bracket are stamped and formed exactly like original and

an excellent reproduction of the one used on all factory 289 HiPo Cars including Shelybs. This bracket bolts directly to the Block. Painted a natural steel color.

Year	Description	Part No.	List
64-65	Upper Steel Stamped Brackets	C30Z-6046-A	\$99. ⁹⁵ PR



The Cast Iron Brackets are identical to original 289 HiPo Brackets used

on the "K" although similar in appearance to standard 1965 Cast Iron brackets they are not interchangeable and must be used when utilizing other HiPo Engine Mount Components. Original Part Numbers cast into the part. Concours Correct. Painted a natural steel color for longevity.

Year	Description	Part No.	List
64-65	Lower Cast Iron Brackets	CSZZ-6030/1-A	\$199. ⁹⁵ PR



These Stamped Steel Brackets are stamped, formed and welded exactly

like original and an excellent reproduction of the ones used on all 289 HiPo Engines. This bracket fits in between Cast Iron Frame Bracket and Upper Engine Bracket. Painted a natural steel color.

Year	Description	Part No.	List
64-65	Intermediate Brackets	CSZZ-6028/9-A	\$149. ⁹⁵ PR

HIGH PERFORMANCE MOTOR MOUNT

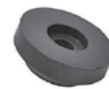

64-65: Factory 289 Hi-Po C20Z-6039

List

\$19.⁹⁵EA



64-65: Factory 289 Hi-Po CSZZ-6038-A

List

\$39.⁹⁵EA

MOTOR MOUNT



Replacement motor mounts. Bonded rubber and steel.

Year	Description	Part No.	List
64-65	260, 289, RH	C3AZ-6038-G	\$19. ⁹⁵ EA
64-65	260, 289, LH	C3AZ-6038-H	\$19. ⁹⁵ EA
67-69	200, RH or LH, Does not fit convertible	C3DZ-6038-E	\$14. ⁹⁵ EA
64-66	6 cyl. RH	C4UZ-6038-A	\$22. ⁹⁵ EA
64-66	6 cyl. LH	C4UZ-6038-B	\$22. ⁹⁵ EA
66-72	289, 302, 351W, 69-70 351C, RH or LH	D0ZZ-6038-B	\$19. ⁹⁵ EA
67-70	390, 428 rubber mount	D1ZZ-6038-A	\$74. ⁹⁵ EA

MOTOR MOUNT BRACKET TO BLOCK BOLTS



Year	Description	Part No.	List
64-73	All engines	304668-S	\$6. ⁵⁰ KT

WE PROUDLY FEATURE AUTHENTIC MUSTANG REPRODUCTIONS FROM SCOTT DRAKE!



MOTOR MOUNT BRACKET

Bolts to frame and motor mount attaches to it. Note: Ford improved their motor mount design in 1966. Our 1966 version is an excellent upgrade for 1964 - 1965 V8 cars and a must for 6 cylinder conversions over to V8 (requires D0ZZ-6038-B mounts).



64-65: V8
C3DZ-6028/9-C

List

\$49.95^{PR}



66-70: 289, 302, 351
C6ZZ-6028/9-A

List

\$109.95^{PR}



67-70
C7ZZ-6028-KIT
67-70: 390, 428

List

\$114.95^{KT}



67-70: 390, 428 engine brackets
C7ZZ-6046-PR

List

\$129.95^{PR}

MOTOR MOUNT BRACKET TO BODY BOLTS



These are the concours correct bolts that attach the engine mount bracket to the base of the shock towers. Serrated flange nuts included. Will fit 64-70.

Year	Part No.	List
66-68	375117-S	\$7.95 ^{PR}

MOTOR MOUNT BRACKET TO INSULATOR BOLTS

These bolts run through both engine mounts and engine mount brackets to secure engine to the car.



66-69: Concours 7/16" bolts
379699-SK

List

\$13.95^{KT}



70-73: Concours 3/8" bolts
56354-SK

List

\$13.95^{KT}

TIMING CHAIN

TIMING CHAIN SETS



Quality timing chain sets in both high performance and stock configurations.

Note: C5ZZ-6268-RK will not fit factory 289 HiPo when using "hatchet" counter balance.

Year	Description	Part No.	List
64-73	Small block, stock replacement	C5ZZ-6268-K	\$28.95 ^{SE}
64-73	Small block roller, high performance	C5ZZ-6268-RK	\$55.95 ^{SE}
70-73	351 Cleveland, stock	D0ZZ-6268-K	\$32.95 ^{SE}

TIMING COVER



A quality after market replacement timing chain cover for cast iron pumps. 289, 302, 351W. Will not fit original style aluminum water pumps.

Year	Description	Part No.	List
65-67	289, 302 For Cast Iron Water Pump Has molded in Timing pointer, concours	C4AZ-6019-B	\$124.95 ^{EA}
66-73	289, 302, 351W For cast iron water pump Requires bolt on pointer	C50Z-6019-B	\$99.95 ^{EA}

TIMING COVER FOR ALUM WATER PUMP

Made by Scott Drake from high-quality die-cast aluminum. This Mustang Timing Chain Cover is an exact reproduction for use with aluminum water pumps, without oil fill tube hole that was used on early cars. Concours.



ORIGINAL PART NUMBER AND DATE STAMP

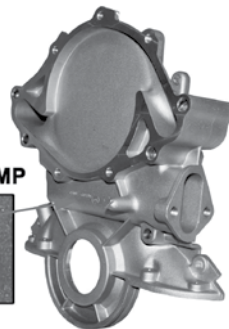
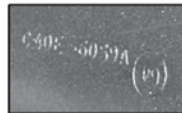

Year	Description	Part No.	List
63-65	260, 289 For alum. water pump	C4AZ-6019-A	\$149.95 ^{EA}

TIMING CHAIN SETS



Everything you need, also includes crank shaft seal and sleeve.

Year	Description	Part No.	List
64-73	6 cyl	CODE-6020-C	\$34.95 ^{SE}
64-73	Small block	C40Z-6020-A	\$34.95 ^{SE}
67-73	Big block	C9ZZ-6020-D	\$34.95 ^{SE}
70-73	351 Cleveland	D0ZZ-6020-C	\$39.95 ^{SE}

TIMING COVER MOUNTING KIT



Concours correct fasteners, mounts timing chain cover to engine.

Year	Description	Part No.	List
64-65	6 cyl. w/ generator	TCC-CODE-499	\$7.50 ^{KI}
64	260, 289 w/ generator	TCC-C20E-488	\$11.95 ^{KI}
65-70	6 cyl. w/ alternator	TCC-C5DE-500	\$7.50 ^{KI}
64-67	289 w/ alternator	TCC-C50E-489	\$11.95 ^{KI}
68-69	289, 302 and 351	TCC-C80E-490	\$11.95 ^{KI}

TIMING POINTER



Stamped steel pointer mounts to timing chain cover. Black zinc-plated. Includes mounting screw. Fits 289, 302, 351W

Year	Part No.	List
64-73	C20Z-6023-B	\$7.95 ^{EA}

INTAKE MANIFOLD

INTAKE MANIFOLD

Add to your cars performance and beauty with these highly polished or satin finished intake manifolds.



Year	Description	Part No.	List
64-85	Satin	C30Z-9424-S	\$219.95 ^{EA}
64-85	Satin, Crosswind	C30Z-9424-CWS	\$254.95 ^{EA}
64-85	Polished	C30Z-9424-P	\$279.95 ^{EA}
64-85	Polished, Crosswind	C30Z-9424-CWP	\$319.95 ^{EA}

INTAKE MANIFOLD BOLT KIT



Concours correct with the exact head markings. Not an off the shelf generic

copy. These are 100% correct or your money back!

Year	Description	Part No.	List
67-68	390, 428	IMB-B8AE-475	\$31.95 ^{KI}
67	GT500	IMB-C3AE-493	\$44.95 ^{KI}
64-67	260, 289	IMB-C40E-478	\$24.95 ^{KI}
68-69	289, 302	IMB-C80E-479	\$24.95 ^{KI}
69-70	Boss 429	IMB-C9AE-1376	\$44.95 ^{KI}
69	351 W	IMB-C90E-1131	\$24.95 ^{KI}
69-70	390, 428	IMB-C90E-476	\$34.95 ^{KI}
69	Boss 302	IMB-C9ZE-1306	\$74.95 ^{KI}
70-73	351 2V	IMB-D00E-1313	\$26.95 ^{KI}
70-73	302	IMB-D00E-1123	\$26.95 ^{KI}
70-73	351 Cleveland 4V	IMB-D00E-1321	\$26.95 ^{KI}
70	Boss 302	IMB-DOZE-1320	\$74.95 ^{KI}
68	GT500	IMB-S8ME-477	\$41.95 ^{KI}

INTAKE MANIFOLD WASHER KIT



Very special aluminum washers which are rubber coated. These are the correct ones. Helps eliminate oil leaks. 12 piece kit.

Year	Part No.	List
64-67	IMW-C40E-702	\$11.95 ^{KI}

VACUUM MODULATOR LINE



Runs from intake manifold to modulator on transmission. Includes rubber attaching hose on each end.

Year	Description	Part No.	List
65-66	C-4, steel	MVT001	\$22.00 ^{EA}
65-66	C-4, Stainless	MVT001S	\$28.50 ^{EA}
64-65	C-4, V8, steel	MVT002	\$22.00 ^{EA}
64-65	C-4, V8, Stainless	MVT002S	\$28.50 ^{EA}
64-68	6 cyl., steel	MVT003	\$26.95 ^{EA}
64-68	6 cyl., Stainless	MVT003S	\$36.95 ^{EA}
67-69	C-4, V8, steel	MVT004	\$22.00 ^{EA}
67-69	C-4, V8, Stainless	MVT004S	\$22.00 ^{EA}
71-73	C-4, V8, steel	MVT005	\$24.00 ^{EA}
71-73	C-4, V8, Stainless	MVT005S	\$29.95 ^{EA}
71-73	C-6, 351, steel	MVT006	\$24.00 ^{EA}
71-73	C-6, 351, Stainless	MVT006S	\$28.50 ^{EA}
68-69	C-6, V8, steel	MVT007	\$22.00 ^{EA}
68-69	C-6, V8, Stainless	MVT007S	\$22.00 ^{EA}

INTAKE MANIFOLD GASKET



Year	Description	Part No.	List
64-73	Small block	C3AZ-9441-A	\$19.95 ^{SE}
69	351W	C9ZZ-9441-W	\$30.95 ^{SE}

OIL RELATED PARTS

ENGINE OIL DIP STICK TUBE



Original design from Ford Blue Prints available painted or chrome. Perfect fit

Year	Description	Part No.	List
64	260, black	C20Z-6754-A	\$9.50 ^{EA}
64	260, chrome	C20Z-6754-C	\$11.95 ^{EA}
65	289, black	C5AZ-6754-A	\$9.50 ^{EA}
65	289, chrome	C5AZ-6754-C	\$11.50 ^{EA}
66-67	289, blue	C6AZ-6754-A	\$9.50 ^{EA}
66-67	289 chrome	C6AZ-6754-C	\$11.50 ^{EA}
67-70	390, 428 blue	C70Z-6754-A	\$20.50 ^{EA}
67-70	390, 428 chrome	C70Z-6754-C	\$22.50 ^{EA}
68-69	Blue, 68: 289, 302; 69: 302	C8AZ-6754-A	\$9.50 ^{EA}
68-69	Chrome, 68: 289, 302; 69: 302	C8AZ-6754-C	\$11.50 ^{EA}
69	351W blue	C90Z-6754-A	\$9.50 ^{EA}
69	351W chrome	C90Z-6754-C	\$11.50 ^{EA}

ENGINE OIL DIPSTICK



Our dip sticks are exact reproductions. Don't confuse these with generic imported versions that are kind of close. Stainless

steel versions are polished.

Year	Description	Part No.	List
64	Small block, w/ generator, light grey	C30Z-6750-B	\$13.95 ^{EA}
64	Small block, w/ generator, chrome	C30Z-6750-C	\$14.95 ^{EA}
68-73	Blue, OE style, 289/302	C5AZ-6750-A	\$11.95 ^{EA}
68-73	Stainless handle, OE style, 289/302	C5AZ-6750-AC	\$12.95 ^{EA}
65-67	Blue, OE style, 289	C5AZ-6750-B	\$11.95 ^{EA}
65-67	Stainless handle, OE style, 289	C5AZ-6750-BC	\$12.95 ^{EA}
67-70	390-428 Chrome	C70E-6750-A	\$29.95 ^{EA}

BILLET OIL DIPSTICK



Mustang Oil Dipstick Handle (Billet) with stick.

Year	Description	Part No.	List
65-73	Billet	B-6750	\$32.95 ^{SE}

ENGINE OIL DIP STICK WITH TUBE



Resembles the original. All chrome plated. Note: Due to different water pump designs, mounting bracket may need to be modified. Not concours.

Year	Description	Part No.	List
64-73	Chrome	C5ZZ-6750-K	\$9.95 ^{EA}
69-73	351W chrome	C9ZZ-6750-K	\$9.95 ^{EA}
70-73	351 Cleveland chrome	D0ZZ-6750-K	\$9.95 ^{EA}

OIL FILTER

We have concours oil filters available. A must for any show. All are silk-screened with multiple colors.



64-70: Gold, 6000 mile
C1AZ-6731-6000



List

\$32.95^{EA}



64-73: White/Red
Autolite
C1AZ-6731-FL1F



List

\$32.95^{EA}



64-73: Red Rotunda
C1AZ-6731-RIA



List

\$32.95^{EA}



64-88: Motorcraft
FL-1A



List

\$8.95^{EA}



64-88: Motorcraft, HiPo
FL-1HP



List

\$18.95^{EA}

WE PROUDLY FEATURE AUTHENTIC MUSTANG REPRODUCTIONS FROM SCOTT DRAKE!



OIL DRAIN PLUG

Correct oil drain plug with nylon gasket. Either plain or magnetic.



64-73: Stock w/ gasket
D1AZ-6730-A

List

\$1.95^{EA}



64-73: Magnetic
CSZZ-6730-M

List

\$7.50^{EA}

CHROME OIL FILTER COVER



Quality chrome finish. Slips on your standard oil filter. Secures by tightening allen bolt. Fits all standard oil filters.

Year	Part No.	List
64-73	CSZZ-6731-C	\$8.95 ^{EA}

OIL PAN

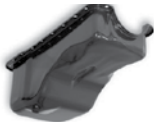

*On small block versions see website for capacity and possible fitment issues on the 1964-65 PS cars

Year	Description	Part No.	List
64-70	6 cyl., black	C4DZ-6675-B	\$179.95 ^{EA}
64-73	Small block V8, black	CSZZ-6675-A*	\$49.95 ^{EA}
64-73	Small block, blue	CSZZ-6675-B*	\$49.95 ^{EA}
64-73	Small block, chrome	CSZZ-6675-C*	\$64.95 ^{EA}
64-73	Small block, unpainted	CSZZ-6675-R*	\$44.95 ^{EA}
67-70	Concours: 390GT-428CJ, blue w/ part #, baffle, and FoMoCo stamp	C60Z-6675-A	\$189.95 ^{EA}
67-70	Big block, blue (except CJ)	C7ZZ-6675-B	\$79.95 ^{EA}
67-70	Big block, chrome (except CJ)	C7ZZ-6675-C	\$85.95 ^{EA}
69-73	351W, blue	C9ZZ-6675-B	\$59.95 ^{EA}
69-73	351W, chrome	C9ZZ-6675-C	\$74.95 ^{EA}
70-73	351 Cleveland, chrome	DOZZ-6675-C	\$82.95 ^{EA}
71	429, chrome	D1ZZ-6675-C	\$91.95 ^{EA}

CAL CUSTOM OIL PAN



Scott Drake is proud to reintroduce the famous "Cal Custom" aluminum finned oil pan that was so popular throughout the 60's, 70's and 80's. It has not been available for Part No.s, but it is back again and now even better than before! Not only do these pans look great fully polished with raised fins but they also offer the added benefit of reducing oil temperature to help your engine run cooler. We have even added a strong magnetic drain plug to help protect your engine from destructive metallic particles floating in your oil. These Oil Pans fit: 260, 289, and 302. Also available "Cal Custom" Aluminum Finned Valve Covers (CSZZ-6A582-AF) and Air Cleaner (CSZZ-9600-AFK)

Year	Description	Part No.	List
64-73	260, 289, 302	CSZZ-6675-ALUM	\$139.95 ^{EA}

OIL PAN BOLT KIT



Yes, judges do look under your car! Don't get points taken off because of the wrong bolt. These are concours correct.

Year	Description	Part No.	List
67-70	Big block	OPB-B8AE-340	\$21.95 ^{KI}
64-73	Small block and 6 cyl.	OPB-CODE-484	\$16.95 ^{KI}
69-71	429	OPB-C8SE-486	\$19.95 ^{KI}
70-73	351 Cleveland	OPB-D00E-485	\$16.95 ^{KI}

OIL PAN GASKET KIT



Quality gasket set made by FELPRO®.

Year	Description	Part No.	List
64-73	6 cyl.	C3DZ-6781-AK	\$22.95 ^{SE}
64-73	Small block	CSZZ-6781-K	\$19.95 ^{SE}
67-70	Big block	C7ZZ-6781-D	\$22.95 ^{SE}
69	351W	C9ZZ-6781-W	\$22.95 ^{SE}
70-73	351 Cleveland	DOZZ-6781-C	\$22.95 ^{SE}

OIL PAN, BAFFLE, & TUBE KIT

For Mustang 260/289/302 engines, this kit, from Scott Drake, includes our popular small block oil pan (unpainted) with the same design of baffle used in the Boss 302, and Boss 302 style oil pickup tube. Reduces the possibility of oil starvation during extreme driving, this kit comes ready to install and paint. Baffle and oil pickup are exact reproductions. Note: CSZZ-6675 oil pan holds about 6 quarts of oil.



65-73: Oil Pan, Baffle, and Tube - fits 260/289/302
CSZZ-6675/22-K

List

\$149.95^{KI}



65-73: Baffle & Tube only
CSZZ-6675/22-B

List

\$112.50^{KI}



69-70: Boss 302 Tube only
C9ZZ-6622-B

List

\$54.95^{EA}

OIL PRESSURE SENDER EXTENSION

A Beautiful reproduction by Scott Drake. Hex shaped extension. Made from machined metal and chrome or zinc plated.



64-73: 289-302, zinc
C20Z-9B339-A

List

\$24.95^{EA}



64-73: 289-302, chrome
C20Z-9B339-C

List

\$26.95^{EA}

OIL PRESSURE SENDING UNIT

These senders screw into block and activate warning light when oil pressure is lost or give accurate reading to oil pressure gauge on cars equipped with gauges.



64-65: Warning light
67-70: w/ factory tach
B6AZ-9278-A

List

\$8.50^{EA}



67-68: Without factory tach, with spade connector
C7ZZ-9278-A

List

\$27.95^{EA}



65-66: w/ oil pressure gauge
69-73: w/ oil pressure gauge
C9ZZ-9278-A

List

\$25.95^{EA}

OIL PRESSURE SENDER ADAPTER



Machined brass adapter threads on to C9ZZ-9278-A sender. This allows the use of C9ZZ-9278-A oil pressure sender on 1967-1968 vehicles. Correct style 67-68 sender is no longer available.

Year	Part No.	List
67-68	C7ZZ-9278-ADAPT	\$3.75 ^{EA}

OIL PUMP



These name brand oil pumps are made in the U.S.A. to insure performance and reliability.

Year	Description	Part No.	List
64-73	260, 289, 302	C5ZZ-6600-A	\$45 ^{.95} EA
70-73	351 Cleveland	DOZZ-6600-A	\$49 ^{.95} EA

SMOG COMPONENTS

SMOG DIVERTER VALVE



These are made by Carter, the original supplier to Ford. Not a reproduction but New Old Stock. No Ford part number stamped on case. Very Limited Supply!

Year	Description	Part No.	List
70-72	Boss 302 and Boss 429	C8TZ-9B289-AR	\$136 ^{.95} EA

SMOG PUMP FILTER



Brought to you by Scott Drake. New open cell foam.

Year	Part No.	List
66-67	C6AZ-9A496-A	\$9 ^{.95} EA

SMOG PUMP BELT



All belts are constructed by the original manufacturer and made in the U.S.A. Each belt is concours correct with all the authentic inked markings. All belts are approved by Mustang Club of America and are recognized as concours correct.

Year	Description	Part No.	List
68-70	428 Cobra Jet, and Super Cobra Jet w/out AC	C60E-8620-B	\$24 ^{.95} EA
69-70	428 Cobra Jet and Super Cobra Jet w/ AC	C8ZE-8620-C	\$24 ^{.95} EA
70	Boss 302	DOZZ-8620-A	\$34 ^{.95} EA

AIR CONDITIONER BELT



All belts are constructed by the original manufacturer and made in the U.S.A.

Each belt is concours correct with all the authentic inked markings. All belts are approved by Mustang Club of America and are recognized as concours correct.



Year	Description	Part No.	List
65-69	Small block 65-67 & 69 before 1-23-69	C4ZE-8620-B	\$26 ^{.95} EA
67-68	Small block after 1-2-67	C70E-8620-D	\$26 ^{.95} EA
70	302, 351W, 351 Cleveland	DOAE-8620-H	\$26 ^{.95} EA

POWER STEERING BELT



All belts are constructed by the original manufacturer and made in the U.S.A.

Each belt is concours correct with all the authentic inked markings. All belts are approved by Mustang Club of America and are recognized as concours correct.



Year	Description	Part No.	List
64-65	260/289 w/ generator and Eaton pump	C30E-8620-B	\$24 ^{.95} EA
65	260/289 w/ AC	C5AE-8620-E	\$24 ^{.95} EA
67	390/428 w/out AC	C5AE-8620-L	\$24 ^{.95} EA
65-66	260/289 w/ Ford pump, w/out AC	C5AE-8620-U	\$24 ^{.95} EA
65	200 w/out AC and Ford pump	C5DE-8620-E	\$24 ^{.95} EA
68-70	390GT/428CJ/428SCJ w/ AC	C6AE-8620-T	\$24 ^{.95} EA
68-69	302/351W w/out AC & before 10-2-69	C6DE-8620-G	\$24 ^{.95} EA
67-68	289 w/ AC	C60E-8620-A	\$24 ^{.95} EA
66	289 w/ AC	C60E-8620-D	\$24 ^{.95} EA
67	289 w/out AC	C6TA-8620-J	\$24 ^{.95} EA
68-69	390/428CJ/428SCJ w/out AC & before 10-2-69	C85E-8620-B	\$24 ^{.95} EA
69-70	390/428CJ/428SCJ w/out AC & after 10-2-69	C90E-8620-D	\$24 ^{.95} EA
70-71	351 Clev/429 w/ AC & 302 w/out AC	DOAE-8620-K	\$24 ^{.95} EA
70-71	351C/351 Boss/429 w/out AC	DOOE-8620-A	\$24 ^{.95} EA
70	Boss 302 w/out AC and 351W w/ AC	DOZE-8620-A	\$24 ^{.95} EA
70	351W w/out AC	DOZE-8620-B	\$24 ^{.95} EA

MISC DRESS-UP

UNDER-HOOD STAINLESS TRIM



This kit will really dress up your engine compartment. High quality polished stainless steel panels and all attaching hardware included. Complete with installation instructions.

Year	Part No.	List
64-66	ACC-UHT-65	\$299 ^{.95} EA
67-68	ACC-UHT-67	\$299 ^{.95} EA
69-70	ACC-UHT-69	\$299 ^{.95} EA

HOOD PROP ROD



This prop rod is made from high quality 304 stainless steel rod and polished to really catch the eye.

Year	Description	Part No.	List
64-68	Stainless	C5ZZ-16826-S	\$34 ^{.95} EA
65	Shelby	S1MS-16826	\$28 ^{.95} EA

RADIATOR SUPPORT TO HOOD

BUMPERS



Made by Scott Drake these new bumpers offer an upgraded appearance made from machined stainless steel and soft rubber. Directly replaces your original hood bumpers..

Year	Description	Part No.	List
64-73	Stainless	C5ZZ-16763-S	\$24 ^{.95} PR

WE PROUDLY FEATURE AUTHENTIC MUSTANG REPRODUCTIONS FROM SCOTT DRAKE!



EXHAUST SYSTEM

HI-PERFORMANCE 6 CYL. EXHAUST HEADERS

We believe that a properly modified 6 cyl. will put out as much usable low RPM horsepower as a V8. We offer both the single and dual outlet versions. Single outlet is recommended if no other modifications will be made. Dual outlets work best with Hi-Po Camshaft, 2V carb and Pertronix Ignitor. Single outlet also works well with these modifications. Dual outlet is for customers that want the look and sound of a V8. We recommend buying an exhaust port divider (part # C3OZ-9430-EPD) which smooths out air flow between the #3 and #4 cylinder. Will fit Mustangs, Falcons, Rancheros, Comets, Fairlanes, Torinos, and Mavericks.



64-73: Single outlet, nickel plated, fits 170, 200, 250
C3OZ-9430-H1

List

\$384.⁹⁵ KI



64-69: Dual outlet, nickel plated, fits 170, 200
C3OZ-9430-H2

List

\$389.⁹⁵ KI

6-CYL. EXHAUST PORT DIVIDER



Smooths out air flow between #3 and #4 exhaust ports to improve economy and performance. Can be used with standard exhaust manifold and headers. Welding recommended but not required.

Year	Description	Part No.	List
64-73	170, 200, 250	C3OZ-9430-EPD	\$21. ⁹⁵ EA

SHORTY EXHAUST HEADERS



Note: 64-65 Mustangs will require 1966-1970 motor mounts and brackets for proper clearance (see "Engine" category). Quality header at an affordable price. Nickel plated.

Year	Description	Part No.	List
64-70	1 5/8" shorty	CSZZ-9430-SH	\$369. ⁹⁵ PR

MODIFIED TRI-Y EXHAUST HEADERS



Made by Scott Drake, these Tri-Y Headers resemble traditional Tri-Y's in appearance, with subtle changes to enhance fit and performance! 16 Gauge Tubes are CNC mandrel bent, then carefully installed in our precision engineered welding jig for a perfect fit, and precision welded by a master craftsmen. Many hours have been invested on making these fit and perform. They have been fitted on multiple applications and we find them superior to previous suppliers. These fit both automatic and manual transmissions with the more common 157 Tooth small bell housing, along with extra clearance for starter, mounting flange bolts can easily be accessed and they clear Shock Towers.* Provides full articulation of steering assembly without interference. Note: Power Steering cars require Drop Down Bracket see below. Cars with the larger Bellhousing for 164 Tooth Flywheel will need to dimple header and possibly remove a minimal amount of material on Bellhousing as well for proper clearance. We have also shortened the collector tubes to improve floor pan clearance. Over forty years of Mustang modifications have resulted in endless configurations and combinations, but we believe this product offers the best overall fit and appearance so far. Fits 260, 289, and 302. All Headers include extra thick 5/16 inch flanges to prevent warping which are precision ground. Metal composite flange gaskets, 1 1/2 inch Primaries, 1 3/4 inch Secondary's and 2 1/2 inch Collectors. Includes Reducer Cones which taper to 2 inches with gaskets and all necessary mounting hardware.

Year	Description	Part No.	List
64-68	Black painted	CSZZ-9430-BK	\$184. ⁹⁵ PR

304 Stainless Steel

Our stainless steel version features Polished Stainless construction, including the 5/16 inch mounting flange, most manufacturers call their headers all stainless, but actually use regular steel which is nickel plated steel to reduce costs. Ours are all 100% Stainless Steel right down to the flange mounting bolts. The best money can buy, no corners have been cut.

Year	Description	Part No.	List
64-68	304 Polished Stainless Steel	CSZZ-9430-SS	\$324. ⁹⁵ PR
64-68	Silver Ceramic Coating	CSZZ-9430-CC	\$374. ⁹⁵ PR

*Note: 64-65 V8 Engine Mounts sit the engine approximately 1/4" lower than the 66 and up mounts. Although unlikely, it may be required to shim your engine up especially if mounts are older and have partially collapsed to gain more shock tower clearance. This can be done simply with some washers.

TRI-Y EXHAUST HEADERS



These feature 1/4" flanges, miter cut 16 gauge tubes & are precision Mig welded to ensure a proper fit & eliminate exhaust leaks. Comes boxed complete with premium gaskets, all necessary mounting hardware & reducer cones. Fits 260, 289, and 302.

Year	Description	Part No.	List
64-68	Small block, black, non high-temp	S1MS-9430-BL	\$194. ⁹⁵ SE
64-68	Small block, nickel plated	S1MS-9430-CR	\$239. ⁹⁵ SE

TRI-Y POWER STEERING DROP BRACKET

A must when using Tri-Y headers on a power steering car. Lowers power steering for proper clearance when using Tri-Y headers. Now made by Drake, this part features thicker metal, better welds, and correct sized bushing holes.

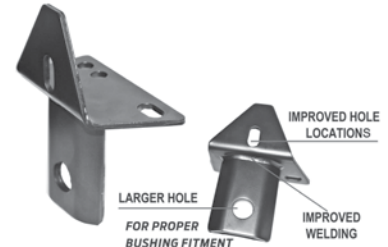

Year	Part No.	List
64-70	DBPP-10961-A	\$22. ⁹⁵ EA

SMALL BLOCK STANDARD EXHAUST MANIFOLDS

These standard manifolds are cast from high quality molds for proper fit and appearance. Includes exhaust flange bolts and nuts. Fits 260, 289, 302



Year	Part No.	List
64-73	CSZZ-9430/1-DE	\$199. ⁹⁵ PR

SMALL BLOCK HIGH PERFORMANCE EXHAUST MANIFOLDS

Previously obsolete, these 1964-66 Mustang High Performance Exhaust Manifolds are now available by Scott Drake. Engineered exactly like original for longevity and trouble free installation. These authentic cast iron reproductions feature correct markings and raised part numbers for early high performance cars, but will work well on all 1964 - 1973 small block Mustangs..



Official
Licensed
Product

Year	Part No.	List
64-73	C5Z-9430/1-B	\$324.95 PR

EXHAUST MANIFOLD

These manifolds are cast from high quality molds for proper fit and appearance. Includes exhaust flange bolts, nuts and washers. Unless indicated manifolds are w/o casted part numbers.



64-67: Fits 170-200
C30Z-9430-AR

List
\$124.95 EA



68-70: Cobra Jet 428
C80Z-9430/1-BC

List
\$759.95 PR

MANIFOLD STUDS WITH NUTS



These 7/16"x14 studs are 2.25" long and will work on all 6 cylinders and V8 exhaust manifolds except RH Big Block with spacer.

Year	Description	Part No.	List
64-66	2.375" Long TL .62 x 1.125	380345-S	\$4.50 PR

EXHAUST MANIFOLD BOLT KIT

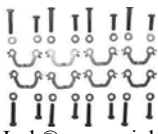

Exact copies made from the original supplier to Ford Motor Co. U.S.A. made. 1966 and up feature Ramp-Lok®, a special conical washer designed specifically for exhaust manifolds.

Year	Description	Part No.	List
64-65	6 cyl.	EMB-CODE-554	\$19.95 SE
64-65	Small block, 260-289	EMB-C20E-555	\$24.95 SE
64-65	289 High Performance	EMB-C30E-556	\$28.95 SE
66-67	200 6 cyl.	EMB-C6DE-525	\$19.95 SE
66-67	289	EMB-C60E-527	\$23.95 SE

Year	Description	Part No.	List
67-68	390 GT and GT500	EMB-C70E-539	\$28.95 SE
68-73	200, 250 6 cyl.	EMB-C8DE-526	\$19.95 SE
68-73	Small block	EMB-C80E-529	\$23.95 SE
68-69	390 GT, late 1968	EMB-C80E-540	\$28.95 SE
68-69	428 Cobra Jet	EMB-C80E-542	\$31.95 SE
69-70	Boss 429	EMB-C9AE-543	\$31.95 SE
69	302, 351W	EMB-C90E-530	\$23.95 SE
69-70	Boss 302	EMB-C9ZE-531	\$28.95 SE
70-71	351 Cleveland 2 Barrel	EMB-D00E-533	\$23.95 SE
70-71	351 Cleveland 4 Barrel	EMB-D00E-534	\$23.95 SE
71	429 Cobra Jet	EMB-D00E-544	\$31.95 SE
72-73	351 Cleveland 2 Barrel	EMB-D20E-535	\$23.95 SE
72-73	351 Cleveland 4 Barrel	EMB-D20E-536	\$23.95 SE

EXHAUST MANIFOLD LOCKING

TAB



Features zinc plating and the correct annealing

for crack-free bends. Locks manifold bolts in place, prevents them from turning.

Part No.	Year	Description	List
C20Z-9A447-A	64-66	260, 289	\$15.00 SE
C30E-9A447-A	64-65	289 HiPo, set of 8	\$16.95 SE

EXHAUST MANIFOLD GASKET



Gasket between the cylinder head and the exhaust manifold.

Year	Description	Part No.	List
64-68	6 cyl. w/ exhaust manifold	C3DZ-9433-A	\$15.95 EA
64-73	170, 200 w/ headers	C3DZ-9433-HDR	\$24.00 EA
70-73	351 Cleveland 4 Barrel	D0ZZ-9433-B	\$21.95 PR

EXHAUST MANIFOLD GASKET KIT



Includes exhaust manifold gaskets, pipe flange gaskets and exhaust manifold to pipe gaskets

Year	Description	Part No.	List
64-73	260, 289, 302, 351W	C5Z-9433-A/B	\$22.95 PR

EXHAUST PIPE FLANGE GASKET



Donut shaped gasket between the manifold and the down pipe.

Year	Description	Part No.	List
64-68	6 cyl.	C30Z-9450-A	\$3.95 EA
64-73	Small block and 6 cyl.	C30Z-9450-B	\$3.95 EA
69-73	351W and 351 Cleveland	C9ZZ-9450-A	\$4.95 EA
67-70	390	C9ZZ-9450-D	\$4.95 EA

EXHAUST MANIFOLD HEAT RISER



Tube which attaches to air cleaner and mounts to the R.H. exhaust manifold. C8ZZ-9a603-A pictured.

Year	Description	Part No.	List
65-67	289	C5ZZ-9A603-B	\$78.95 EA
68-72	289, 302	C8ZZ-9A603-A	\$78.95 EA

EXHAUST MANIFOLD HEAT SHROUD BOLT



Screws into RH exhaust manifold.

Year	Description	Part No.	List
65-67	289	379008-S	\$5.95 EA

EXHAUST MANIFOLD HEAT RISER STUD



Year	Part No.	List
64-68	379763-S	\$1.75 EA

6 CYL. HEAD PIPE HANGER BRACKET



Year	Description	Part No.	List
64-67	6 cyl., single	C4DZ-5291-A	\$11.95 EA

**WE PROUDLY FEATURE AUTHENTIC MUSTANG
REPRODUCTIONS FROM SCOTT DRAKE!**



CONCOURS EXHAUST "H" & "Y" PIPES

We now offer the most comprehensive line of exhaust products for 1964 -1973 Mustangs and 1965-70 Shelby's. These Exhaust products are of premium quality and made to original factory specifications in the USA. All of our products have been test fitted on the appropriate Mustang prior to production to insure a trouble free installation.

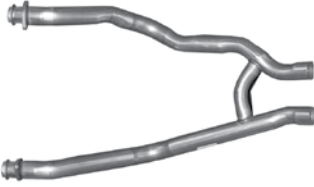

Year	Description	Part No.	List
64-66	6 cyl. exhaust head pipe 1.75"	CSZZ-5246-D	\$42. ⁵⁰ A
64-66	260-289 single exhaust Y pipe	CSZZ-5246-F	\$99. ⁹⁵ EA
64-68	Small block, dual, standard manifolds, 2"	CSZZ-5246-J	\$86. ⁹⁵ EA
64-66	Small block, dual, Hi-Po manifolds, 2"	CSZZ-5246-K	\$97. ⁹⁵ EA
64-66	Small block, dual, Hi-Po manifolds, 2.25"	CSZZ-5246-B	\$96. ⁹⁵ EA
64-66	Small block, dual, std manifolds, 2.25"	CSZZ-5246-L	\$96. ⁹⁵ EA
67	289 single exhaust Y pipe 2"	C7ZZ-5246-A	\$82. ⁹⁵ EA
67	6 cyl. exhaust pipe 2" - Automatic only	C7ZZ-5246-J	\$44. ⁹⁵ EA
67-68	390 GT exhaust H pipe 2" - Requires factory spacer	C7ZZ-5246-M	\$96. ⁹⁵ EA
68-70	200 exhaust head pipe 2" - Fits both A/T & M/T	C8ZZ-5246-B	\$44. ⁹⁵ EA
69	351W exhaust H pipe 2.25"	C9ZZ-5246-A	\$104. ⁹⁵ EA
68-70	428CJ exhaust H pipe 2.25" - Requires factory spacer	C9ZZ-5246-F	\$82. ⁹⁵ EA
69	390GT H exhaust pipe 2" - For use w/out spacer	C9ZZ-5246-T	\$84. ⁹⁵ EA
69-70	BOSS 302 2.5" reduced to 2.25"	C9ZZ-5246-H	\$104. ⁹⁵ EA
70	351C-2V exhaust H pipe 2.25"	D0ZZ-5246-N	\$84. ⁹⁵ EA
70	351C-4V exhaust H pipe 2.25" - Will not fit 2V	D0ZZ-5246-A	\$94. ⁹⁵ EA
70	428CJ exhaust H pipe 2.25" - For use w/out spacer	D0ZZ-5246-D	\$92. ⁹⁵ EA
71-73	351C-4V exhaust H pipe 2.25"	D1ZZ-5246-FR	\$84. ⁹⁵ EA
71-73	351C-2V exhaust H pipe 2.25"	D1ZZ-5246-S	\$84. ⁹⁵ EA

CONCOURS EXHAUST SYSTEM

We now offer the most comprehensive line of exhaust products for 1964 -1973 Mustangs and 1965-70 Shelby's. These Exhaust products are of premium quality and made to original factory specifications in the USA. All of our products have been test fitted on the appropriate Mustang prior to production to insure a trouble free installation. We use only the heaviest gauge aluminized tubing available. Mufflers have correct factory brackets when needed and are also aluminized to eliminate early rust out. All Kits are compression bent just like originals for that Concours look. H-Pipes or Y-Pipes not included and Hanger kits are sold separately.



Year	Description	Part No.	List
64-66	6 cyl. single exhaust system 1.75"	CSZZ-5257-ARK	\$246. ⁹⁵ EA
64-66	V8 single exhaust system 2" - w/out resonator or Y pipe	CSZZ-5257-BRK	\$236. ⁹⁵ KT
64-66	V8 single exhaust system - Includes resonator, no Y pipe	CSZZ-5257-DRK	\$264. ⁹⁵ KT
65-66	GT exhaust system 2" - w/out resonator or H pipe - Year GT tips	CSZZ-5257-WOR	\$249. ⁹⁵ EA
65-66	GT exhaust system 2" - Includes resonator, no H pipe - fits GT tips	CSZZ-5257-WRS	\$334. ⁹⁵ KT
67	289 single exhaust system 2" - w/out resonator or Y pipe	C7ZZ-5257-BRK	\$239. ⁹⁵ KT
67-69	289, 302, 351, 390, 428 OEM Dual exhaust system 2" - Transverse single muffler	C8ZZ-5257-CRK	\$546. ⁹⁵ KT
68-70	6 cyl. exhaust system 2"	C8ZZ-5257-LRK	\$179. ⁹⁵ EA
67-69	289, 302, 351, 390, 428 OEM Dual exhaust system 2.25" - Transverse single muffler	C9ZZ-5257-CRE	\$449. ⁹⁵ KT
70	OEM Boss 302/429 exhaust sys 2.25" - Req turn downed tips	D0ZZ-5257-BOS	\$419. ⁹⁵ KT
70	OEM Mach1 exhaust sys - For staggered shock cars only	D0ZZ-5257-MCH	\$433. ⁹⁵ KT
70	OEM 351/428 Mach1 exhaust sys - w/out staggered shocks	D0ZZ-5257-MWO	\$419. ⁹⁵ KT
71-73	Non-Mach dual exhaust sys 2.25" - Req turn downed tips	D1ZZ-5257-ARK	\$254. ⁹⁵ KT
71-73	Mach1 dual exhaust sys 2.25" - Req Mach1 tips	D1ZZ-5257-TRK	\$244. ⁹⁵ KT

PERFORMANCE EXHAUST SYSTEM

These Exhaust products are of premium quality and made to original factory specifications in the USA. Only the heaviest gauge aluminized tubing available is used for these Exhaust Systems. Mufflers have correct factory brackets when needed and are also aluminized to eliminate early rust out. All Kits are compression bent just like originals for that Concours look. H-Pipes and Hanger kits are sold separately. This has exact same bends and Curves as original 2" Exhaust systems. If running Factory GT Exhaust Tips modification is required on end of Tail Pipe and Exhaust Tip. Also due to very tight clearances on Convertibles in the Seat Pan Reinforcement Area. Professional Installation is recommended especially for Convertibles.

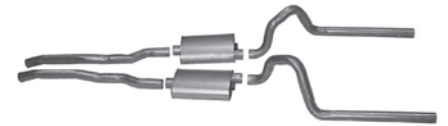

Year	Description	Part No.	List
65-69	V8 Flowmaster exhaust sys 2.25" - Delta flow, no H pipe	CSZZ-5257-FLM	\$419. ⁹⁵ KT
64-69	V8 turbo exhaust system 2.25" - No H pipe	CSZZ-5257-TTQ	\$244. ⁹⁵ EA

DUAL EXHAUST KIT

Original replacement, dual exhaust system for 1964-66 260 and 289. Can also be adapted for 1967-68 289 and 302 cars. This kit consists of the "H" pipe, the intermediate pipes, mufflers and exhaust pipes. Made from aluminized steel. All clamps and hangers are sold separately. Will work with either GT tips or turn downs. Modification may be required to clear convertible reinforcement plate.



Year	Description	Part No.	List
64-66	Complete system, Standard manifolds w/o resonators, No clamps or hangers, 2" diameter	CSZZ-5246/30-K	\$279. ⁹⁵ KT
64-66	Complete system, Standard manifolds w/ GT resonators, no clamps or hangers, 2" diameter	CSZZ-5246/30-KR	\$304. ⁹⁵ KT

K GT EXHAUST KIT

Complete aluminized exhaust system for high performance "K" 289 cu.in. Mustangs. Diameter is 2 inches. **This kit fits factory HiPo exhaust manifolds only.** Available with or without resonators. Modification may be required to clear convertible reinforcement plate.

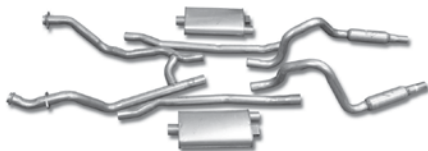

Year	Description	Part No.	List
64-66	W/out resonators	C5ZZ-5246/30-HP	\$289 ⁹⁵ KT
64-66	W/ resonators	C5ZZ-5246/30HPR	\$319 ⁹⁵ KT

MUFFLER



Features fully aluminized double wall construction, exact OEM dimensions and proper attaching

brackets when required. Easy to install compared to generic replacements.

Year	Description	Part No.	List
64-66	V8, single exhaust	C5ZZ-5230-D	\$72 ⁹⁵ EA
64-66	6 cyl.	C5ZZ-5230-T	\$72 ⁹⁵ EA
65-66	Dual exhaust, OEM bracket,	C6ZZ-5230-E	\$62 ⁵⁰ EA
67	Small block, single exhaust	C7ZZ-5230-A	\$72 ⁹⁵ EA
67	6 cyl.	C7ZZ-5230-D	\$72 ⁹⁵ EA
68-70	6 cyl. 200	C8ZZ-5230-A	\$64 ⁹⁵ EA
68-70	Small block, single exhaust	C8ZZ-5230-B	\$64 ⁹⁵ EA
69	Transverse Dual exhaust	C9ZZ-5230-C	\$84 ⁹⁵ EA
70	Dual exhaust, 302, 351 bracket not included	D0ZZ-5230-B/D	\$56 ⁹⁵ EA

CONCOURS 1965-66 GT EXHAUST TIPS

Made by Scott Drake these are the finest reproductions available and are a must for any concours restoration. Correct deep draw louvered stamping, no visible welded seam on a highly polished stainless steel cone, perfect fit between louvered cap and stainless steel cone. Easy install on our original 2" exhaust systems



Year	Description	Part No.	List
65-66	GT, concours	C5ZZ-5255-PRO	\$99 ⁹⁵ PR

HIGH-FLOW 1965-66 GT EXHAUST TIPS



These are a Scott Drake Exclusive! We take our concours tips, use a larger diameter straight 2" pipe

(easily expanded to 2.25"), and open up louvers for a better flow while still offering a factory appearance. These flow over 20% better than original restrictive tips, a must for any high-horsepower car. Not a direct fit to original exhaust systems.

Year	Description	Part No.	List
65-66	GT, 2" high-flow	C5ZZ-5255-GT2	\$99 ⁹⁵ PR

EXHAUST TIPS

We have the largest selection of concours and economy tips to meet all your customers' needs!



65-66: GT, economy reproduction
C5ZZ-5255-C/D

List
\$49⁹⁵ PR



67-69: Original style, concours w/
correct rolled tip 2" exhaust
C7ZZ-5258-C

List
\$89⁹⁵ PR



67-69: High flow design w/
correct rolled tip
Stainless steel, fits 2.25" exhaust
pipe
C7ZZ-5258-GT2

List
\$99⁹⁵ PR



70: Mach 1, concours w/ correct
rolled tip
D0ZZ-5255-A

List
\$129⁹⁵ PR

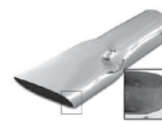

67-70: Mach 1, economy
reproduction
D0ZZ-5255-AR

List
\$49⁹⁵ EA



71-73
D1ZZ-5225-G

List
\$52⁹⁵ EA



67: Eleanor, cast aluminum, side
exhaust
S7MS-5255-E

List
\$359⁹⁵ PR

EXHAUST TURN DOWN TIPS



65-66: Turn down tips 2" reduced to 1.875"
C5ZZ-5257-TIP

List
\$22⁹⁵ PR



67-73: Turn down tips 2.25"
C8ZZ-5257-TIP

List
\$27⁹⁵ PR

GT EXHAUST TRIM RINGS



Beautiful addition to the rear valance, finishes off the cut out for the exhaust pipe. Our concours version is polished stainless steel like the originals.

Year	Description	Part No.	List
65-66	Concours, S/S	C5ZZ-5C299-A	\$15 ⁹⁵ EA
65-66	Economy, chrome	C5ZZ-5C299-AR	\$13 ⁹⁵ EA

EXHAUST HANGER KIT



These concours correct exhaust kits are easy to order and offer a savings versus buying all components individually.

Year	Description	Part No.	List
64-66	V8 single exhaust hanger mount kit 2"	C5ZZ-5257-1HMK	\$40 ⁹⁵ KT
65-66	Dual exhaust hanger mount kit 2"	C5ZZ-5257-2AHMK	\$114 ⁹⁵ KT
65-66	Dual exhaust hanger mount kit 2.25" Oversized	C5ZZ-5257-2BHMK	\$114 ⁹⁵ KT
64-66	6 cyl. exhaust hanger mount kit	C5ZZ-5257-6HMK	\$40 ⁹⁵ EA
67	6 cyl. single exhaust hanger mount kit 1.75"	C7ZZ-5257-1HMK	\$82 ⁹⁵ KT
67	6-8 cyl. single exhaust hanger mount kit 2"	C7ZZ-5257-2HMK	\$75 ⁹⁵ EA
68-70	V8 single exhaust hanger mount kit 2"	C8ZZ-5257-1AHMK	\$55 ⁹⁵ KT
68-70	Single exhaust hanger mount kit 2.25"	C8ZZ-5257-1BHMK	\$59 ⁹⁵ KT
67-69	Dual exhaust hanger mount kit 2" - Original transverse muffler	C8ZZ-5257-2AHMK	\$116 ⁹⁵ KT
67-69	Dual exhaust hanger mount kit 2.25" Original transverse muffler	C8ZZ-5257-2BHMK	\$116 ⁹⁵ KT





WE PROUDLY FEATURE AUTHENTIC MUSTANG REPRODUCTIONS FROM SCOTT DRAKE!



Year	Description	Part No.	List
64-66	V8 single exhaust hanger mount kit 2"	C5ZZ-5257-1HMK	\$40 ⁹⁵ KT
65-66	Dual exhaust hanger mount kit 2"	C5ZZ-5257-2AHMK	\$114 ⁹⁵ KT
65-66	Dual exhaust hanger mount kit 2.25" Oversized	C5ZZ-5257-2BHMK	\$114 ⁹⁵ KT
64-66	6 cyl. exhaust hanger mount kit	C5ZZ-5257-6HMK	\$40 ⁹⁵ EA
67	6 cyl. single exhaust hanger mount kit 1.75"	C7ZZ-5257-1HMK	\$82 ⁹⁵ KT
67	6-8 cyl. single exhaust hanger mount kit 2"	C7ZZ-5257-2HMK	\$75 ⁹⁵ EA
68-70	V8 single exhaust hanger mount kit 2"	C8ZZ-5257-1AHMK	\$55 ⁹⁵ KT
68-70	Single exhaust hanger mount kit 2.25"	C8ZZ-5257-1BHMK	\$59 ⁹⁵ KT
67-69	Dual exhaust hanger mount kit 2" - Original transverse muffler	C8ZZ-5257-2AHMK	\$116 ⁹⁵ KT
67-69	Dual exhaust hanger mount kit 2.25" Original transverse muffler	C8ZZ-5257-2BHMK	\$116 ⁹⁵ KT
70	Dual exhaust hanger mount kit 2.25" Factory Dual Exhaust Hanger Kit	D0ZZ-5257-2HMK	\$102 ⁹⁵ KT
71-73	Dual exhaust hanger mount kit 2.25" OEM	D0ZZ-5257-2HMK	\$102 ⁹⁵ KT

EXHAUST HANGER

A variety of hangers to keep exhaust systems at stock positions.

	65-68: LH C5ZZ-5A246-A
	List \$14 ⁹⁵ EA
	65-68: RH C5ZZ-5A246-B
	List \$14 ⁹⁵ EA
	65-66: LH or RH, dual exhaust. C5ZZ-5A246-D
	List \$19 ⁹⁵ EA
	70-73: RH, Dual exhaust D0ZZ-5260-A (RH) D0ZZ-5260-B (LH)
	List \$17 ⁹⁵ EA
	65-69: Rear, dual C6ZZ-5266-AR
	List \$9 ⁹⁵ EA

EXHAUST HANGER INSULATOR



This insulator does just that, it secures the pipe to the hanger and absorbs vibration. The rubber pad keeps it from rattling against the undercarriage. For 1965 through 1969 Mustangs with V8 engines and dual factory exhaust. You need two of these.

Year	Part No.	List
65-70	C5ZZ-5260-B	\$10 ⁹⁵ EA

REAR UPPER EXHAUST BRACKET



Year	Description	List
65-70	LH, GT	\$14 ⁹⁵ EA
65-70	RH, GT	\$14 ⁹⁵ EA

CUSTOM REAR UPPER EXHAUST BRACKET





This custom bracket allows you to use factory GT Exhaust Hanger System without Drilling holes in your Frame Rails which is very difficult to do because of limited space, a real time saver that utilizes factory Tie Down holes in Rear Frames Rails

Year	Description	Part No.	List
64-66		C5ZZ-5277-CR	\$39 ⁹⁵ PR

EXHAUST PIPE CLAMP

Pipe clamps in both original and replacement styles.

	65-69: Original (horse shoe) style C5ZZ-5A231-A
	List \$24 ⁹⁵ PR
	65-68: Replacement type C6ZZ-5A231-AR
	List \$6 ⁹⁵ EA

EXHAUST HANGER RETAINER



Used on dual exhausts cars this mounts to floor under rear seat. Attaches exhaust muffler hanger C5ZZ-5A246-D to floor. Includes hardware. Not exact copy of original.

Year	Description	Part No.	List
65-70	Dual exhaust	C5ZZ-5A247-A	\$11 ⁹⁵ PR

FUEL SYSTEM

ACCELERATOR COMPONENTS

ACCELERATOR CABLE



Cable link between the accelerator pedal and the linkage to the carburetor.

Year	Description	Part No.	List
69	302, 351, 390, and 428	C9ZZ-9A758-A	\$34 ⁹⁵ EA
70	302, 351 and 428	C9ZZ-9A758-E	\$35 ⁹⁵ EA

ACCELERATOR LINKAGE KIT



Kit comes complete with accelerator linkage rod, bushings and clip kit, return spring, and bracket.

Year	Description	Part No.	List
64-67	289 2 Barrel	C5ZZ-9A702-2K	\$28 ⁹⁵ KI
64-67	289 4 Barrel	C5ZZ-9A702-4K	\$28 ⁹⁵ KI

ACCELERATOR LINKAGE ROD



Rod which connects carb to main linkage. Gold zinc plated. Also available in chrome.

Year	Description	Part No.	List
64-67	Chrome	C5ZZ-9A702-C	\$14 ⁹⁵ EA
65-67	Gold zinc	C5ZZ-9A702-D	\$12 ⁹⁵ EA

BILLET ACCELERATOR LINKAGE ROD



Made by Drake, 1964-68 Mustang V8 Billet Throttle Linkage Rod is a machined billet aluminum rod with stainless rod ends. Includes stainless steel hardware.

Year	Part No.	List
64-68	C5ZZ-9A702-BL	\$39 ⁹⁵ KI

**ACCELERATOR LINKAGE ROD
BUSHING KIT**



All the necessary hardware needed for a trouble free installation. Includes rubber insulator bushing,

nylon insert bushing, cotter key, washer and carb to linkage clip.

Year	Part No.	List
64-67	C5ZZ-9A702-MK	\$11.95 ^{KI}

RETURN SPRING BRACKET



Neat detail item, stamped steel with zinc plating.

Year	Description	Part No.	List
64-68	2 Barrel	C3AZ-9741-A	\$7.95 ^{EA}
65-66	2 Barrel*	C5ZZ-9741-A	\$7.95 ^{EA}
64-66	4 Barrel	C5ZZ-9741-C	\$7.95 ^{EA}
64-65	Bell crank	C5ZZ-9741-K	\$7.95 ^{EA}

* Also for 66-68 C4 Transmission Kick Down

ACCELERATOR RETURN SPRING



Correct spring, black phosphorus plated.

Year	Part No.	List
64-68	C5ZZ-9737-B	\$4.95 ^{EA}

ACCELERATOR ROD GROMMET



This is the small rubber grommet that attaches where the accelerator rod meets the linkage rod to ensure a smooth pivot without sticking.

Year	Part No.	List
64-69	379009-S	\$5.95 ^{EA}

ACCELERATOR MOUNTING SCREW



A precision machined screw with exact detail. Painted black. Made by Scott Drake.

Year	Part No.	List
64-68	380503-S101	\$2.95 ^{EA}
69-70	C80Z-9873	\$5.50 ^{EA}

ACCELERATOR PEDAL



These steel reinforced parts are molded from high quality rubber for a long life and great appearance.

Year	Description	Part No.	List
64-68	W/ stainless trim	C5ZZ-9735-D	\$9.95 ^{EA}
69-70	W/out trim	C9ZZ-9735-D	\$14.95 ^{EA}
71-73	W/out trim	D1ZZ-9735	\$16.50 ^{EA}

ACCELERATOR PEDAL SPRING



Made of strong spring steel for a long life. Made by Drake.

Year	Description	Part No.	List
64-68	Spring steel	C5ZZ-9760-B	\$2.95 ^{EA}
69-70	Spring steel	C90Z-9760	\$3.95 ^{EA}

PEDAL PIVOT ASSEMBLY



Better quality and fit. Painted detail gray.

Year	Description	Part No.	List
64-65	260, 289 All	C5ZZ-9725-A	\$59.95 ^{EA}
66-68	289, 302 Automatic 289, 302, 390 Manual	C6ZZ-9725-B	\$62.50 ^{EA}

ACCELERATOR PEDAL ASSEMBLY



Replace your mis-aligned pedal with a new safer unit.

Year	Part No.	List
69	C9ZZ-9735-K	\$74.95 ^{EA}

KICK DOWN CABLE



Kick Down Cable - 10.2" long. Fits 6 cylinder and V8.

Year	Part No.	List
66-68	C60Z-7A187-D	\$10.95 ^{EA}

**TRANSMISSION KICK DOWN CABLE
KIT**



A 9-piece kit, our Transmission Kick Down Cable Kit includes our cable, lever, spring & bracket, along with all the hardware for simple installation. C4 Transmissions.

Year	Part No.	List
66-68	C60Z-7A187-KIT	\$35.95 ^{KIT}

CARBURETOR COMPONENTS

CARBURETOR SPACER

A nice reproduction of a part that is commonly in need of replacement.



65-68: 289 4 barrel
C30Z-9A589-C

List
\$40.95 ^{EA}



64-68: 6 cyl.
C60Z-9A589-A

List
\$59.95 ^{EA}

CARBURETOR SPACER GASKET



The gasket that goes between the spacer and the manifold and between the manifold and carburetor.

Year	Description	Part No.	List
64-66	4 Barrel	C2AZ-9447-E	\$3.95 ^{EA}
64-73	2 Barrel	C3AZ-9447-B	\$3.95 ^{EA}
64-73	6 cyl.	C3DZ-9447-A	\$3.95 ^{EA}
67-70	4 Barrel	C7ZZ-9447-A	\$5.95 ^{EA}
67-70	4 Barrel	C7ZZ-9447-D3	\$5.95 ^{EA}
67-70	4 Barrel	C7ZZ-9447-D4	\$3.95 ^{EA}

**WE PROUDLY FEATURE AUTHENTIC MUSTANG
REPRODUCTIONS FROM SCOTT DRAKE!**



CHOKE/HEAT RISER AND RELATED

CHOKE TUBE KIT



We have these steel tubes made for us to exacting O.E.M. standards and specifications. All choke tubes have the proper fiberglass insulation, fittings, rubber hose, and S-clip. Also includes cold air tube when applicable. A part# ending in "S" denotes stainless steel.

Year	Description	Part No.	List
64-69	64-69: 170, 200	MCT003S	\$17.50 ^{EA}
64-69	64-69: 170, 200 Stainless	MCT003S	\$17.50 ^{EA}
70	70: 200	MCT004	\$13.95 ^{KI}
70	70: 200 Stainless	MCT004S	\$17.50 ^{EA}
64-73	64-73: 260, 289, 302, 2 BBL. 64-66: 260, 289-2 or 4 BBL. 69: 351W-2BBL	MCT001	\$19.95 ^{EA}
64-73	64-73: 260, 289, 302, 2 BBL. 64-66: 260, 289-2 or 4 BBL. 69: 351W-2BBL Stainless	MCT001S	\$28.95 ^{SE}
67-68	67: "A" code, 289, 4 BBL. 68: "J" code, 302, 4 BBL.	MCT008	\$24.95 ^{KI}
67-68	67: "A" code, 289, 4 BBL. 68: "J" code, 302, 4 BBL. Stainless	MCT008S	\$29.95 ^{EA}
67-68	67-68: 390, Big block	MCT002	\$24.95 ^{EA}
67-68	67-68: 390, Big block Stainless	MCT002S	\$29.95 ^{EA}
67	67: 428, dual 4 BBL., Shelby only	MCT007	\$25.95 ^{EA}
67	67: 428, dual 4 BBL., Shelby only Stainless	MCT007S	\$36.95 ^{EA}
68-69	68-69: 428 CJ	MCT009	\$23.95 ^{KI}
68-69	68-69: 428 CJ Stainless	MCT009S	\$31.95 ^{EA}
69-70	69: 351W, 4 BBL. 70: 351, 4 BBL., Shelby	MCT005	\$24.00 ^{KI}
69-70	69: 351W, 4 BBL. 70: 351, 4 BBL., Shelby Stainless	MCT005S	\$31.95 ^{EA}
70-73	70-73: 2 BBL., 4 BBL.	MCT011	\$15.95 ^{KI}
70-73	70-73: 2 BBL., 4 BBL. Stainless	MCT011S	\$23.95 ^{EA}
64-73	64-73: Universal kit for headers	MCT014	\$31.95 ^{SE}

CHOKE CABLE



This is the exact replacement for the manual choke cable. Mounting hardware is included.

Originally built for High Performance 289.

Year	Part No.	List
65-66	CSZZ-9700-AR	\$72.50 ^{EA}

CHOKE THERMOSTAT SHIELD



This stamped steel part bolts to carburetor and holds heater hose against choke.

Year	Part No.	List
65-69	CSZZ-9861	\$24.95 ^{EA}

FUEL LINES, FILTERS, AND PUMPS

FUEL FILTER

Filters protect your carburetor from costly repairs by trapping dirt. For original carburetor's only. Please confirm thread size you need.



65-73: In line C2RZ-9155-A

List

\$6.95^{EA}



64-65: Element
C4AZ-9365-B

List

\$9.95^{EA}



66-67: V8, w/ 7/16" threads
C5AZ-9155-B

List

\$9.95^{EA}



68-71: Boss and Big Block
D3AZ-9155-C

List

\$10.50^{EA}



66-73: 6-cyl. and Small Block
D30Z-9155-B

List

\$9.50^{EA}



64-73: 5/16"
W892588

List

\$9.25^{EA}



64-73: 3/8"
W894188

List

\$8.50^{EA}

FUEL HOSE



Quality made hose with concurs repeating GAS markings. Also include OEM mounting hardware.

Year	Description	Part No.	List
64-68	5/16"	CSZZ-9327-A	\$10.50 ^{KI}
67-73	3/8"	C7ZZ-9327-A	\$10.50 ^{KI}

FUEL PUMP

These original style diaphragm pumps are all-new, not rebuilt. Includes mounting gasket. Not concurs.



Year	Description	Part No.	List
64-65	170, 200 and 240 engines	C3AZ-9350-Y	\$52.95 ^{EA}
66-68	289, 302	C5AZ-9350-B	\$44.95 ^{EA}
64-65	Early 260 and 289	C50Z-9350-A	\$49.95 ^{EA}
66-67	200 6 cyl.	C5UZ-9350-C	\$46.95 ^{EA}
67	390	C6AZ-9350-B	\$49.95 ^{EA}
68-70	428 engine	C7AZ-9350-A	\$84.95 ^{EA}
68-73	200 and 250 6 cyl.	D3TZ-9350-A	\$52.95 ^{EA}
70-73	351 Cleveland	D7SZ-9350-C	\$49.95 ^{EA}
68-69	390	D8TZ-9350-C	\$49.95 ^{EA}

FUEL PUMP FILTER CANISTER

Concours correct, and quality reproduction with silk-screened logo and authentic markings..



Year	Description	Part No.	List
64-65	W/ original markings & logo	C3AZ-9355-A	\$19.95 ^{EA}
64-65	Gold zinc no logo	C3AZ-9355-G	\$8.95 ^{EA}

FUEL PUMP MOUNTING GASKET



Always replace this gasket when replacing the fuel pump. Made in the U.S.A.

Year	Part No.	List
64-73	C3AZ-9417-C	\$2.95 ^{EA}

FUEL PUMP REBUILD KIT



Use this kit to rebuild your original Carter fuel pump on your Boss 302, Boss 429, 428PI, 428CJ or 429 SCJ. This kit will work only on pumps with a screw together body.

Year	Part No.	List
67-73	C7AZ-9349-A	\$39.95 ^{KIT}

PUMP TO CARBURETOR FUEL LINE



These reproduction fuel lines are exact duplicates of the originals, and feature all the correct fittings.

Available in original steel or corrosion resistant stainless steel.

Year	Description	Part No.	List
64-65	170	MGL006	\$20.00 ^{EA}
64-65	170, stainless	MGL006S	\$27.50 ^{EA}
66-67	200	MGL004	\$20.00 ^{EA}
66-67	200, stainless	MGL004S	\$27.50 ^{EA}
68-70	200	MGL017	\$20.00 ^{EA}
68-70	200, stainless	MGL017S	\$27.50 ^{EA}
64	260	MGL003	\$20.00 ^{EA}

Year	Description	Part No.	List
65	289, stainless	MGL001S	\$27.50 ^{EA}
66-67	289	MGL002	\$20.00 ^{EA}
66-67	289, stainless	MGL002S	\$27.50 ^{EA}
64-65	289 w/ Holley	MGL011	\$19.95 ^{EA}
64-65	289 w/ Holley, stainless	MGL011S	\$27.50 ^{EA}
66-67	289 w/ Holley 715	MGL021	\$19.95 ^{EA}
66-67	289 w/ Holley 715, stainless	MGL021S	\$27.50 ^{EA}
67-70	390, 428 police interceptor	MGL007	\$20.00 ^{EA}
67-70	390, 428 police interceptor, stainless	MGL007S	\$27.50 ^{EA}
67	390 2 barrel, stainless	MGL014S	\$27.50 ^{EA}
67	390 4 barrel	MGL015	\$20.00 ^{EA}
67	390 4 barrel, stainless	MGL015S	\$27.50 ^{EA}
67	428 8 barrel	MGL020	\$20.00 ^{EA}
68	302 4 barrel	MGL022	\$20.00 ^{EA}
68	302 4 barrel, stainless	MGL022S	\$27.50 ^{EA}
68-70	289, 302 2 barrel	MGL005	\$20.00 ^{EA}
68-70	289, 302 2 barrel, stainless	MGL005S	\$27.50 ^{EA}
69	351, 4 barrel	MGL009	\$20.00 ^{EA}
69	351, 4 barrel, stainless	MGL009S	\$27.50 ^{EA}
69-70	Boss 302	MGL010	\$20.00 ^{EA}
69-70	Boss 302, stainless	MGL010S	\$27.50 ^{EA}
69-70	Boss 429	MGL008	\$20.00 ^{EA}
70-73	351 Cleveland 2 barrel	MGL016	\$20.00 ^{EA}
70-73	351 Cleveland 2 barrel, stainless	MGL016S	\$27.50 ^{EA}
70-73	351 4 barrel	MGL013	\$20.00 ^{EA}
70-73	351 4 barrel, stainless	MGL013S	\$27.50 ^{EA}
70-73	429 Cobra Jet	MGL018	\$20.00 ^{EA}
70-73	429 Cobra Jet, stainless	MGL018S	\$27.50 ^{EA}
70-73	429 Super Cobra Jet	MGL019	\$20.00 ^{EA}
70-73	429 Super Cobra Jet, stainless	MGL019S	\$27.50 ^{EA}
71	302 2 bbl.	MGL024	\$20.00 ^{EA}
71	302 2 bbl., stainless	MGL024S	\$27.50 ^{EA}
71	Boss 351 Cleveland	MGL023	\$20.00 ^{EA}
71	Boss 351 Cleveland, stainless	MGL023S	\$27.50 ^{EA}

TANK TO PUMP FUEL LINE



Features corrosion resistant lines with the correct fittings. Because of their long length, all lines are gently bent so they are FedEx shippable. These are easily straightened upon receipt.

Year	Description	Part No.	List
64-67	64-Early 67: 6 cyl., 5/16, 1 piece	MLG004	\$78.00 ^{EA}
64-67	64-Early 67: 6 cyl., 5/16, 1 piece, stainless	MLG004S	\$111.00 ^{EA}
67	6 cyl., 5/16, 2 piece	MLG007	\$78.00 ^{EA}
67	6 cyl., 5/16, 2 piece, stainless	MLG007S	\$105.50 ^{EA}
68-70	6 cyl., 3/8, 2 piece	MLG008	\$71.00 ^{EA}
68-70	6 cyl., 3/8, 2 piece, stainless	MLG008S	\$100.00 ^{EA}
71-73	6 cyl., 5/16, 1 piece	MLG010	\$78.00 ^{EA}

Year	Description	Part No.	List
71-73	6 cyl., 5/16, 1 piece, stainless	MLG010S	\$104.50 ^{EA}
64-67	V8, 5/16, 1 piece	MLG002	\$78.00 ^{EA}
64-67	V8, 5/16, 1 piece stainless	MLG002S	\$111.00 ^{EA}
65-66	Larger (3/8") for high performance cars (Shelby)	MLG012	\$90.95 ^{EA}
67	V8, 5/16, 2 piece	MLG003	\$78.00 ^{EA}
67	V8, 5/16, 2 piece, stainless	MLG003S	\$105.95 ^{EA}
68	V8, 3/8, 2 piece except cars w/ staggered shocks	MLG009	\$71.00 ^{EA}
68	V8, 3/8, 2 piece except cars w/ staggered shocks, stainless	MLG009S	\$105.95 ^{EA}
68-70	V8, 3/8, 2 piece, all, including Boss302 and Boss 429	MLG001	\$78.00 ^{EA}
68-70	V8, 3/8, 2 piece, w/ staggered shocks, including Boss 302 and Boss 429, stainless	MLG001S	\$105.95 ^{EA}
69-70	V8, 3/8, 2 piece	MLG005	\$78.00 ^{EA}
69-70	V8, 3/8, 2 piece, stainless	MLG005S	\$105.50 ^{EA}
71-73	V8, 3/8, 2 piece	MLG006	\$78.00 ^{EA}
71-73	V8, 3/8, 2 piece, stainless	MLG006S	\$105.50 ^{EA}
71-73	V8, 5/16, 1 piece, w/ vapor return line	MLG011	\$78.00 ^{EA}
71-73	V8, 5/16, 1 piece, w/ vapor return line, stainless	MLG011S	\$105.50 ^{EA}

FUEL LINE BRACKET



Mounts to the drivers side of the water pum[to secure fuel line on its path to the carburetor.

Year	Part No.	List
64-65	C5Z-9D319	\$12.95 ^{EA}
66	C6OZ-9180-A	\$14.95 ^{EA}

BRAKE AND FUEL LINE CLIP KIT



Convenient kit which mounts front to rear gas lines and long brake line. Kit includes all clips, fasteners and instructions.

Year	Part No.	List
64-67	380374-MK	\$15.95 ^{SE}

FUEL LINE GROMMET

This is the grommet that protects the fuel line as it passes through the driver's side inner fender panel.



64-67: 5/16"
C5Z-9288

List
\$1.95^{EA}

WE PROUDLY FEATURE AUTHENTIC MUSTANG REPRODUCTIONS FROM SCOTT DRAKE!





67-70: 3/8"
C7ZZ-9288

List

\$1.95^{EA}



71-73: Two-hole
D1ZA-9K288-AA

List

\$5.95^{EA}



71-73: 3/8", one-hole
D1ZZ-9288

List

\$1.95^{EA}

FUEL TRANSFER LINE



This line transfers fuel from the front fuel bowl to the rear fuel bowl on Holley carburetors.

Year	Description	Part No.	List
64-67	715 Holley	MGL012	\$19.95 ^{EA}
64-67	715 Holley, Stainless	MGL012S	\$21.95 ^{EA}

CARBURETOR ACCELERATOR PUMP



This Diaphragm Pump mounts on the front all 64-73 Autolite 2V carbs as well as 64-67 Autolite 4V Carbs. With today's

Gas these commonly fail, especially when sitting for extended periods of time. Complete failure will cause dangerous fuel leaks, but many times these will affect performance well before a leak actually starts. Good idea to replace every 2-3 years or if sitting for 6 months or more.

Year	Part No.	List
64-73	C4AZ-9B559-A	\$6.95 ^{SE}

FUEL TANKS & COMPONENTS

FUEL FILLER TUBE



Fuel inlet filler tube. Perfect copy of the original. Plated to stop corrosion.

Year	Description	Part No.	List
64-66		CSZZ-9034-B	\$34.95 ^{EA}
67-68		C7ZZ-9034-A	\$34.95 ^{EA}
69		C9ZZ-9034-A	\$34.95 ^{EA}
70	W/out California emissions	DOZZ-9034-A	\$37.95 ^{EA}

ELEANOR GAS CAP CONVERSION KIT



This kit is used to relocate the gas cap to the driver's side "B" pillar as typically seen on Eleanor Mustangs.

Kit includes everything needed for an authentic conversion.

Year	Part No.	List
67-68	S7MS-9030/9034K	\$394.95 ^{KT}

FUEL FILLER FLANGE GASKET

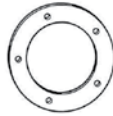

These reproduction seals are made from fuel resistant cork and are perfect replacements for restorations or service. Will

prevent fuel spills or water from entering the trunk area via the filler tube flange.

Year	Part No.	List
64-71	CSZZ-9076-A	\$1.95 ^{EA}

FUEL FILLER HOSE



American made fuel resistant rubber. Perfect fit. Available with red stripes and Autolite logo.

Year	Description	Part No.	List
64-67	4", all black	C4GY-9047-A	\$8.95 ^{EA}
64-67	W/ Autolite logo	C4GY-9047-AL	\$12.95 ^{EA}
65-70	6", all black, W/out CA emissions	C8ZA-9047	\$9.95 ^{EA}
68-70	W/ logo, 70 w/out CA emissions	C8ZA-9047-AL	\$16.95 ^{EA}

FUEL FILLER PIPE TO TRUNK FLOOR SEAL



Year	Description	Part No.	List
71-73	Fuel Filler Pipe to Trunk Floor Seal	D1ZZ-9008	\$24.95 ^{EA}
71-73	Fuel Tank To Filler Pipe Seal	D1ZZ-9072	\$17.50 ^{EA}

1964-67 GAS TANK INSTALLATION KIT



This kit includes all of the necessary hardware to install any of the three available 16 gallon Scott Drake fuel tanks in 64-67 Mustangs.

Each kit features the following: 5/16" standard fuel sending unit, fuel sending unit gasket, fuel filler hose, fuel filler neck gasket, fuel filler neck screws and fuel tank mounting hardware. Fuel pipe hose clamps are sold separately under part number, C5ZZ-8287. New fuel sender retainer ring is included with fuel tank.

Year	Part No.	List
64-67	CSZZ-9002-5MIK	\$7.95 ^{KIT}

FUEL PIPE HOSE CLAMP



Original style wire clamps for retaining the filler hose to the tank standpipe and filler neck.

Year	Part No.	List
64-70	CSZZ-8287	\$7.95 ^{PR}

FUEL TANK FILLER MOUNT SCREW



Special sheet metal screws used to attach filler tube to tail lamp panel. Cadmium plated. Screw on fuel caps only, not for pop open type.

Year	Description	Part No.	List
64-68	Set of 5	42120-SK	\$2.50 ^{KI}

FUEL TANK SENDING UNITS



Complete sending unit with either original brass float or economy plastic float. Gasket included. Does not include retaining ring. Scott Drake's commitment

to service includes inspecting, pressure testing and performing an OHMS test on 100% of our sending units to help assure a trouble free installation. Features zinc plated steel construction. Also available in stainless steel.

Year	Description	Part No.	List
64-67	Zinc plated steel 5/16" tube brass float	CSZZ-9275-BR	\$44.95 ^{EA}
64-67	Zinc plated steel 5/16" tube plastic float	CSZZ-9275-CR	\$39.95 ^{EA}
64-68	Zinc plated steel 3/8" tube Brass float	C8ZZ-9275-BR	\$39.95 ^{EA}
64-68	Zinc plated steel 3/8" tube plastic float	C8ZZ-9275-CR	\$39.95 ^{EA}
69	Zinc plated steel plastic float	C9ZZ-9275-C	\$44.95 ^{EA}
70	Zinc plated steel plastic float	D0ZZ-9275-C	\$44.95 ^{EA}
71-73	Zinc plated steel plastic float	D1ZZ-9275-C	\$44.95 ^{EA}

STAINLESS STEEL FUEL TANK SENDING UNITS



Year	Description	Part No.	List
64-67	Stainless steel 5/16" tube Brass float	CSZZ-9275-C	\$49.95 ^{EA}
64-68	Stainless steel 3/8" tube Brass float	C8ZZ-9275-CR	\$39.95 ^{EA}
69	Stainless steel brass float	C9ZZ-9275-SS	\$52.95 ^{EA}
70	Stainless steel brass float	D0ZZ-9275-SS	\$52.95 ^{EA}
71-73	Stainless steel brass float	D1ZZ-9275-SS	\$52.95 ^{EA}

SENDING UNIT FLOAT



Correct brass float with original style construction. Lasts longer than cheap plastic floats available on

many imported fuel senders. Plastic floats commonly leak causing premature fuel gauge failure.

Year	Description	Part No.	List
64-73	Brass	COAZ-9202-B	\$5.95 ^{EA}

SENDING UNIT FUEL FILTER



Replaceable filters which attaches to original fuel sending unit.

Year	Description	Part No.	List
64-73	3/8"	D1AZ-9A011-A	\$12.95 ^{EA}
64-73	5/16"	D1FZ-9A011-A	\$12.95 ^{EA}

SENDING UNIT GASKET



Year	Part No.	List
64-73	COAF-9276-A	\$2.19 ^{EA}

SENDING UNIT RETAINING RING



Our reproduction ring features original fit and the same heavy duty steel construction as the original.

Year	Part No.	List
64-73	COAZ-9A307-B	\$4.95 ^{EA}

FUEL TANK FILLER KIT



This convenient kit saves time and money. Will not fit 1970 cars equipped with California Emissions.

Year	Part No.	List
64-67	KIT-FUL-1	\$19.95 ^{KI}
68-70	KIT-FUL-2	\$19.95 ^{KI}

FUEL TANK MOUNTING KIT



Includes eleven cadmium plated sheet metal screws, one black oxide captive washer bolt, and one "J" plate nut.

Year	Part No.	List
64-68	CSZZ-9002-MK	\$4.95 ^{KI}

PREMIUM FUEL TANKS

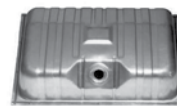

These hand crafted North American gas tanks use industry standard Ni-Terne steel. This high liability part is backed

by a company known for leading the industry in safety and craftsmanship. Seam welded and pressure tested under water twice for integrity. Each tank has a 3 year warranty by the manufacturer. New retaining ring and gasket included.

Year	Description	Part No.	List
64-68	W/ drain plug	CSZZ-9002-D1A	\$134.95 ^{EA}
64-68	W/out drain plug	CSZZ-9002-D2A	\$124.95 ^{EA}
69	20 gallon capacity	C9ZZ-9002-A	\$159.95 ^{EA}
70	22 gallon capacity W/out CA emissions	D0ZZ-9002-A	\$159.95 ^{EA}
71-73		D1ZZ-9002	\$184.95 ^{EA}

STAINLESS STEEL FUEL TANKS



Scott Drake's Stainless Steel Fuel Tanks for the 1964-70 Mustangs offer superior quality to those who demand the very best. Our premium

Stainless Steel Fuel Tanks come with Drain Plug, Locking Ring and Gasket. Featuring a Scott Drake Logo laser etched above the fuel sending unit to clearly define our stamp of approval. Logo is hidden when installed.

Year	Description	Part No.	List
64-68	S/S w/ drain plug	CSZZ-9002-SS	\$294.95 ^{EA}
69	S/S w/ drain plug	C9ZZ-9002-SS	\$299.95 ^{EA}
70	S/S w/ drain plug	C9ZZ-9002-SS	\$299.95 ^{EA}

IMPORTED FUEL TANKS

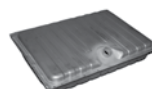

Now available from Scott Drake are these 20 Gallon Imported Fuel Tanks for the 1969 Mustangs. These offer an economical alternative

to our premium American Designer Fuel Tanks. Great for those on a budget or looking to increase proYear on a car they are fixing up to sell. Drain Plug, Locking Ring and Gasket included .

Year	Description	Part No.	List
64-68	Imported 16 gal	CSZZ-9002-DI	\$104.95 ^{EA}
69	Imported 20 gal	C9ZZ-9002-AI	\$119.95 ^{EA}
70	Imported 22 gal	D0ZZ-9002-AI	\$119.95 ^{EA}

WE PROUDLY FEATURE AUTHENTIC MUSTANG REPRODUCTIONS FROM SCOTT DRAKE!



GAS CAPS

GAS CAP



64
No cable
C5ZZ-9030-A



List
\$49.⁹⁵ EA



65
With cable
C5ZZ-9030-B



List
\$49.⁹⁵ EA



65
T5
C5ZZ-9030-C



List
\$69.⁹⁵ EA



66
GT
C6ZZ-9030-A



List
\$59.⁹⁵ EA



66
Standard
C6ZZ-9030-B



List
\$49.⁹⁵ EA



67
Standard
C7ZZ-9030-A



List
\$59.⁹⁵ EA



67: GT pop open
C7ZZ-9030-B



List
\$124.⁹⁵ EA



67
GT Twist on
C7ZZ-9030-C



List
\$69.⁹⁵ EA



67:
Deluxe pop open
C7ZZ-9030-D



List
\$124.⁹⁵ EA



67-68: w/out emblem, use w/
original emblem or our 67-68
Shelby emblems below
C7ZZ-9030-WOE



List
\$94.⁹⁵ EA



67: GT350
Emblem only
S7MS-9030-350



List
\$21.⁹⁵ EA



67: GT500
Emblem only
S7MS-9030-500



List
\$21.⁹⁵ EA



68: GT350/500
Emblem only
S8MS-9030-E



List
\$21.⁹⁵ EA



68: GT500KR
Emblem only
S8MS-9030-KRE



List
\$21.⁹⁵ EA



68
Standard twist on
C8ZZ-9030-A



List
\$59.⁹⁵ EA



68
Deluxe pop open
C8ZZ-9030-C



List
\$124.⁹⁵ EA



68
GT pop open
C8ZZ-9030-D



List
\$124.⁹⁵ EA



69: Standard
Twist on
C9ZZ-9030-A



List
\$59.⁹⁵ EA



69
Deluxe pop open
C9ZZ-9030-A



List
\$124.⁹⁵ EA



69
GT
C9ZZ-9030-A



List
\$174.⁹⁵ EA



70
Non vented
D0ZZ-9030-D



List
\$59.⁹⁵ EA



70: Deluxe
Pop open
D0ZZ-9030-E



List
\$124.⁹⁵ EA



71-73
Vented, no cable
D1ZZ-9030-A



List
\$59.⁹⁵ EA



71-73
Vented w/ cable
D1ZZ-9030-B



List
\$59.⁹⁵ EA



71-73
Mach 1
D1ZZ-9030-C



List
\$139.⁹⁵ SE



66
Shelby GT-350
S2MS-9030-A



List
\$69.⁹⁵ EA

BILLET GAS CAPS

The perfect finishing touch for your "Resto-Mod". Machined from a solid block of billet aluminum. Features our black button head screws and our quality internal components. Security cable included to deter theft. Available with several types of emblems and also in black anodized. Will not fit 1970 cars with California emissions.



64-73
Cobra emblem
B-9030-COBRA



List
\$99.⁹⁵ EA



64-73
GT emblem
B-9030-GT



List
\$99.⁹⁵ EA



64-73
Horse emblem
B-9030-H



List
\$99.⁹⁵ EA



64-7
Plain
B-9030-P



List
\$94.⁹⁵ EA

SHOP WITH CONFIDENCE! WE OFFER SUPERIOR-QUALITY PARTS FOR ALL YOUR MUSTANG RESTORATION NEEDS.

MUSTANG COBRA GAS CAP



Another brilliant addition to Scott Drake's superb line of gas caps. Presented is our handsomely detailed Cobra gas cap with a 3D

Cobra Emblem. This gas cap features a plastic injected, chrome plated center emblem under a clear acrylic dome lens, surrounded by our classic chromed zinc die cast Shelby bezel. Will not fit 1970 cars with CA emissions



Year	Description	Part No.	List
64-73	Cobra	S2MS-9030-C	\$69. ⁹⁵ EA

LOCKING GAS CAP

This original looking cap features a hidden key slot beneath a flip-up cover. Will not fit: 67-70 Shelby's, 68 GT/CS, 70 Mach 1 or any 1970 with California Emission Control.



65-73
CSZZ-9030-L



List
\$74.⁹⁵ EA

LEMANS STYLE ALUMINUM GAS DOOR



This beautiful polished aluminum race style gas door is inspired by the gas caps found on vintage Shelby Cobra race cars. This trick flip-open design functions like the originals used in 1960's racing for quick refuel "pit stops". The outside diameter of the base is smaller at 5.25" to fit on the 64-66 Mustang tail lamp panels. The unique Scott Drake design of the gas door allows installation in four different mounting positions using the factory holes and retains use of the factory fuel filler neck for easy installation. A simple flip of the trigger mechanism pops the door open exposing the twist on gas cap. Gas door has a bright polished finish and includes stainless steel hardware and a twist on gas cap. Note: Will fit 67-68 cars but access to the trunk lock is limited and requires opening gas door to use trunk key. 69 cars have similar trunk lock clearance issue and minor modification would be required on the back side to fit flush against tail lamp panel.

Part No.	Year	Description	List
CSX-9030-A	64-73	Pop open, racing	\$164. ⁹⁵ EA

BLACK BILLET GAS CAP

The perfect finishing touch for your "Resto-Mod". Machined from a solid block of billet aluminum. Features our own silver button head screws and our quality internal components. Security cable included to deter theft. Available in natural finish and with several styles of emblems. Will not fit 1970 cars with California emissions.



64-73: Cobra emblem
B-9030-COBRA-BK



List
\$99.⁹⁵ EA



64-73: GT emblem
B-9030-GT-BK

List
\$99.⁹⁵ EA



64-73: Horse emblem
B-9030-H-BK



List
\$99.⁹⁵ EA



64-73: Plain
B-9030-P-BK

List
\$94.⁹⁵ EA

GAS CAP LOCK



A unique way to stop gas cap theft. Works with twist off type gas caps only. Assembly required.

Year	Part No.	List
64-66	ACC-9030-LOCK	\$9. ⁹⁵ KI

GRILLE

MUSTANG GRILLES



Perfect attention to detail. These grilles are perfect replacements for previously hard to find parts.

Year	Description	Part No.	List
64-65	Standard	CSZZ-8200-CR	\$84. ⁹⁵ EA
64-65	GT, for fog lights	CSZZ-8200-DR	\$84. ⁹⁵ EA
66	All	C6ZZ-8200-AR	\$99. ⁹⁵ EA
67	All	C7ZZ-8200-AR	\$84. ⁹⁵ EA
68	All	C8ZZ-8200-AR	\$99. ⁹⁵ EA
69	Black plastic	C9ZZ-8200-A	\$139. ⁹⁵ EA
70	W/out Sport Lights	DOZZ-8200-A	\$169. ⁹⁵ EA
70	Mach 1	DOZZ-8200-B	\$174. ⁹⁵ EA
71-72	Mach 1 W/ Stainless moldings	D1ZZ-8200-C	\$324. ⁹⁵ EA
71-72	Standard Moldings not included	D1ZZ-8200-DR	\$269. ⁹⁵ EA
73	Standard	D3ZZ-8200-AR	\$262. ⁹⁵ EA
73	Mach 1	D3ZZ-8200-B	\$149. ⁹⁵ EA

MUSTANG BILLET GRILLES



These beautiful billet grilles mount in the existing grill location and look awesome.

Year	Description	Part No.	List
64-66	Billet, polished	CSZZ-8200-BLT	\$179. ⁹⁵ KT
65-66	Lower, for R code car w/ no bumper	CSZZ-8200-RLB	\$166. ⁹⁵ EA
65-66	Lower, for R code car w/ bumper	CSZZ-8200-SLB	\$169. ⁹⁵ EA
67-68	Billet, polished	C7ZZ-8200-BLT	\$189. ⁹⁵ KT
67-68	Eleanor upper and lower	S7MS-8200-E	\$299. ⁹⁵ PR
69	Billet, polished	C9ZZ-8200-BLT	\$214. ⁹⁵ EA

BILLET GRILLE EMBLEM MOUNTING

CLIPS



These steel clips are specially designed to mount the C5ZZ-16229-B Running Horse Fender Emblem to a billet grille.

Year	Part No.	List
64-15	CSZZ-16229-BGMC	\$9. ⁹⁵ PR

WE PROUDLY FEATURE AUTHENTIC MUSTANG REPRODUCTIONS FROM SCOTT DRAKE!



GRILLE CORAL HORSE



Beautiful copy of the original with show quality chrome. All made by Scott Drake.



Year	Description	Part No.	List
64-65	Standard or GT	C5ZZ-8213-AR	\$94. ⁹⁵ EA
66	Standard	C6ZZ-8213-A	\$99. ⁹⁵ EA
66	GT	C6ZZ-8213-B	\$104. ⁹⁵ EA
67	All	C7ZZ-8213-A	\$84. ⁹⁵ EA

GRILLE CORRAL & HORSE KIT



We have combined our beautifully chromed grille horse and small grille corral in one convenient package. Mounting hardware included.



Year	Part No.	List
68	C8ZZ-8213/224-A	\$59. ⁹⁵ SE

GRILLE CORRAL LED LIGHT KIT



Add some flair to the front of your Mustang with a Grille Corral that lights up. Our kits work with your existing 1964-67 Corral and Running Horse emblem. Kits include back reflector panel, waterproof LED modules, and electrical connectors. Simple installation with flexible wiring options. Grille Corral and Horse available separately from Scott Drake.

Year	Part No.	List
64-66	C7ZZ-8213-LED	\$39. ⁹⁵ KI
67	C7ZZ-8213-LED	\$39. ⁹⁵ KI

GRILLE CORRAL

Perfect reproductions with show-quality chrome!



68: Small corral
C8ZZ-8213-A

List
\$30. ⁹⁵ EA



68: Large outer corral
C8ZZ-8419-A

List
\$174. ⁹⁵ EA



71-72: Standard grille
D1ZZ-8419-A

List
\$39. ⁹⁵ EA



73
D3ZZ-8419-A

List
\$54. ⁹⁵ EA

GRILLE EMBLEM



Perfect detail. Mounting hardware included.



Year	Description	Part No.	List
69	Running horse	C9ZZ-8213-AR	\$39. ⁹⁵ KI
70	Running horse	D0ZZ-8213-A	\$29. ⁹⁵ EA

GRILLE HORSE



A brilliant chrome running horse for the standard grille. These are all show-quality. See "Emblem" category for grille emblems.



Year	Part No.	List
64-66	C5ZZ-8A224-B	\$29. ⁹⁵ EA
67	C7ZZ-8A224-A*	\$32. ⁹⁵ EA
68	C8ZZ-8A224-A*	\$28. ⁹⁵ EA
71-72	D1ZZ-8213-A*	\$32. ⁹⁵ EA

GRILLE HORSE



See "Emblem" category for grille emblems.



Year	Part No.	List
71-73	D1ZZ-8213-B*	\$21. ⁹⁵ EA

GRILLE BAR

Our grille bars are pressure die-cast for precision and a perfect fit. Excellent plating and durability, just like the originals. Includes mounting hardware.



64-65
C5ZZ-8390-B/C

List
\$49. ⁹⁵ PR



67
C7ZZ-8390-B/C

List
\$107. ⁹⁵ PR

GRILLE BAR MOUNTING BRACKET

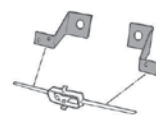

Stamped steel brackets that attach grill bars to grill. Painted black as original.

Year	Description	Part No.	List
64-65	Painted black	C5ZZ-8182/3-A	\$5. ⁰⁰ PR

FOG LIGHT BAR

We believe that we offer the best quality at a price that is reasonable and competitive. Ours are just like the originals - these are pressure die cast in zinc. This process is very expensive, but is the only way to produce a part with high detail and a smooth polished finish, which is the first step toward a superior chrome job.



Year	Part No.	List
65	C5ZZ-8390-D/E	\$89. ⁹⁵ PR
66	C6ZZ-8390-A/B	\$89. ⁹⁵ PR
67	C7ZZ-8390-C/D	\$114. ⁹⁵ PR

FOG LIGHT BAR



Mounts to grill, helps support fog lamps. Good quality steel stampings

Year	Description	Part No.	List
65	GT	C5ZZ-15266/7-A	\$21. ⁹⁵ PR
66	GT New Tooling, Concours	C6ZZ-15266/7-A	\$21. ⁹⁵ PR
67	GT	C7ZZ-15266/7-A	\$24. ⁹⁵ PR
68	GT	C8ZZ-15266/7-A	\$26. ⁹⁵ PR

TRI-BAR FOG LIGHT HOUSING ASSEMBLY



These 4" fog lamps feature our quality fog light housings, beautiful chrome bezels, and include an internal chrome, tri-bar design. The perfect match to our larger, tri-bar headlights.

design. The perfect match to our larger, tri-bar headlights.

Year	Part No.	List
64-67	C5Z-15200-TB	\$104.95 EA

FOG LIGHT HOUSING ASSEMBLY



These Fog Light Housing Assemblies are the best on the market. Assemblies include triple chrome-plated rims, silver painted housings on back, an exact

copy of the wiring harness, cup mounting washer, and serrated flange nut. They also feature the correct wire exit and drain hole. Bulb not included. See "Electrical" section for switches, bulbs and wire harnesses.

Year	Description	Part No.	List
65-67	Concours correct	C5RZ-15200-A	\$37.95 EA
68	W/out correct wire pigtail	C8ZZ-15200-A	\$37.95 EA
68	Blue plug, concours correct	C8ZZ-15200-AC	\$39.95 EA



Without crossbar, or correct pigtail wire.

Year	Part No.	List
68	C8ZZ-15200-SPEC	\$42.95 EA

GRILLE SUPPORT



Year	Description	Part No.	List
64-66	Black concours	C5ZZ-8390-F	\$62.50 EA
64-66	Black economy	C5ZZ-8390-FR	\$42.95 EA

GRILLE SUPPORT BRACKET



Year	Part No.	List
69	C9ZZ-8182-A	\$32.95 EA
70	D0ZZ-8232-A	\$64.95 EA

GRILLE LATCH TOP PLATE



A nice reproduction. Painted black. See "Sheet Metal" section for Grille Supports & Hood Latches.

Year	Part No.	List
64-65	C5ZZ-8194-A	\$12.95 EA

GRILLE MOLDING



Year on outside of grill opening. 64-70 molding includes mounting hardware. For all 71-73 molding, mounting clips are sold separately - See page 181 for 71-73 Mounting Clips.

Year	Description	Part No.	List
64-66	RH, wide	C5ZZ-8242-AR	\$19.95 EA
64-66	LH, wide	C5ZZ-8243-AR	\$19.95 EA
67-68	RH, wide	C7ZZ-8190-AR	\$33.95 EA
67-68	LH, wide	C7ZZ-8191-AR	\$33.95 EA
67-68	RH, narrow	C7ZZ-8242-AR	\$16.95 EA
67-68	LH, narrow	C7ZZ-8243-AR	\$16.95 EA
69	Lower grille panel	C9ZZ-8221-A	\$71.95 EA
69	RH, wide	C9ZZ-8242-AR	\$45.95 EA
69	LH, wide	C9ZZ-8243-AR	\$45.95 EA
69	RH, narrow	C9ZZ-8242-BR	\$45.95 EA
69	LH, narrow	C9ZZ-8243-BR	\$45.95 EA
69	Center, narrow	C9ZZ-8419-AR	\$18.95 EA
70	Center, wide	D0ZZ-8221-A	\$72.50 EA
71-72	Upper or lower	D1ZZ-8419-B	\$32.95 EA
71-72	RH	D1ZZ-8419-C	\$32.95 EA
71-72	LH	D1ZZ-8419-E	\$32.95 EA
73	RH	D3ZZ-8242-A	\$32.95 EA
73	LH	D3ZZ-8243-A	\$32.95 EA
73	Upper or lower	D3ZZ-8419-C	\$32.95 EA

GRILLE MOLDING JOINT COVER

Our own reproduction. Chrome is better than original, recessed area is painted Argent Silver. All necessary fasteners are included.



66: Center
C6ZZ-8221-A

List

\$13.95 EA



67-68: Center Joint
Cover
C7ZZ-8221-AR

List

\$12.95 EA

ENGINE HARDWARE

ENGINE MASTERS FASTENER KITS



These excellent kits include original equipment hardware. These high quality fasteners have been re-tooled and are made identical to the original. Each

kit includes hardware to attach the following: valve covers, air cleaner, intake manifold, oil pan, timing cover, water pump, crank pulley, thermostat housing, heat shield, distributor, carburetor, exhaust manifolds, fuel pump, oil filter adapter, engine tag and ignition coil

Year	Description	Part No.	List
64-65	Small block w/ generator includes exhaust locks	EMK-C20E-322	\$124.95 KI
64	Small block w/ generator and AC	EMK-C20E-336	\$119.95 KI
64	Small block High Performance W/ generator and AC	EMK-C30E-323	\$119.95 KI
65	Small block 289 W/ aluminum water pump & alternator	EMK-C50E-559	\$129.95 KI
65	Small block 289 w/ AC	EMK-C50E-560	\$119.95 KI
65	Small block 289 High Performance W/ aluminum water pump & alternator	EMK-C50E-561	\$119.95 KI
65	Small block 289 W/ cast iron water pump & alternator	EMK-C50E-812	\$129.95 KI
65	Small block 289 High Performance W/ cast iron water pump & alternator	EMK-C5ZE-1067	\$119.95 KI
66	6 cyl.	EMK-C6DE-320	\$94.95 KI

WE PROUDLY FEATURE AUTHENTIC MUSTANG REPRODUCTIONS FROM SCOTT DRAKE!



Year	Description	Part No.	List
66-67	Small block 289 W/ cast iron water pump & Ramp-locs	EMK-C60E-324	\$119. ⁹⁵ KI
66-67	Small block 289 High Performance W/ cast iron water pump & Ramp-locs	EMK-C60E-325	\$114. ⁹⁵ KI
66	Small block 289 W/ cast iron water pump, AC & Ramp-locs	EMK-C60E-337	\$119. ⁹⁵ KI
67	Big block 390 GT	EMK-C70E-330	\$134. ⁹⁵ KI
67	Small block 289 w/ AC	EMK-C70E-562	\$119. ⁹⁵ KI
68-70	6 cyl.	EMK-C80E-321	\$94. ⁹⁵ KI
68	Small block 289, 302	EMK-C80E-326	\$114. ⁹⁵ KI
68-69	Big block 390 GT	EMK-C80E-332	\$134. ⁹⁵ KI
68	Big block 428 Cobra Jet	EMK-C80E-333	\$134. ⁹⁵ KI
68	Small block 289, 302 w/ AC	EMK-C80E-338	\$124. ⁹⁵ KI
69-70	Big block 429 and Boss 429	EMK-C9AE-1182	\$199. ⁹⁵ KI
69-73	6 cyl. 250	EMK-C9DE-342	\$94. ⁹⁵ KI
69	Small block 302	EMK-C90E-1126	\$114. ⁹⁵ KI
69-73	Small block 302 w/ AC	EMK-C90E-1127	\$114. ⁹⁵ KI
69	Small block 351	EMK-C90E-1128	\$114. ⁹⁵ KI
69	Small block 351 w/ AC	EMK-C90E-1129	\$114. ⁹⁵ KI
69-70	Small block GT-350 w/ out AC	EMK-C90E-1188	\$139. ⁹⁵ KI
69-70	Big block 428 Cobra Jet & Super Cobra Jet	EMK-C90E-334	\$134. ⁹⁵ KI
69	Small block Boss 302	EMK-C9ZE-1180	\$199. ⁹⁵ KI
69	Small block 302	EMK-D00E-1130	\$114. ⁹⁵ KI
70	Small block 351W	EMK-D00E-1132	\$124. ⁹⁵ KI
70-71	Small block 351 Cleveland W/ 2 barrel carburetor	EMK-D00E-1175	\$114. ⁹⁵ KI
70-71	Small block 351 Cleveland W/ 4 barrel carburetor	EMK-D00E-1176	\$114. ⁹⁵ KI
70	Small block Boss 302	EMK-D0ZE-1181	\$199. ⁹⁵ KI
71	Boss 351	EMK-D00E-1177	\$144. ⁹⁵ KI
72-73	Small block 351 Cleveland W/ 2 barrel carburetor	EMK-D20E-1178	\$114. ⁹⁵ KI
72-73	Small block 351 Cleveland W/ 4 barrel carburetor	EMK-D20E-1179	\$114. ⁹⁵ KI
65	Small block GT-350	EMK-S1ME-1184	\$139. ⁹⁵ KI
66	Small block GT-350	EMK-S2ME-1185	\$139. ⁹⁵ KI
67	Small block GT-350	EMK-S7ME-1186	\$139. ⁹⁵ KI
67	Big block GT-500	EMK-S7ME-331	\$162. ⁹⁵ KI
68	Small block GT-350	EMK-S8ME-1187	\$-KI
68	Big block GT-500KR & 428 Cobra Jet	EMK-S8ME-382	\$169. ⁹⁵ KI
68	Big block GT-500	EMK-S8ME-677	\$169. ⁹⁵ KI

AIR CLEANER WING NUT



A nice reproduction.

Year	Description	Part No.	List
64-73	1/4-20 thread wing nut	358871-S	\$1. ⁵⁰ EA
64-68	6 cyl. w/ stud	383132-S	\$1. ⁹⁵ EA

BILLET AIR CLEANER KNOB

Here's another nice billet product from Scott Drake. Our air cleaner knob matches our billet radiator cap B-8100 and our billet master cylinder cap B-2162-A. All are beautifully machined and have a soft etched finish. Available with or without the screw hole drilled through. 1/4" x 20 threads.



64-73: solid
B-358871-A

List
\$9.⁹⁵ EA



64-73: w/ hole
B-358871-B

List
\$9.⁹⁵ EA

AIR CLEANER TO SNORKLE NUT



Attaches snorkle to air cleaner. Zinc plated.

Year	Part No.	List
64-67	358462-S7	\$3. ⁷⁵ PR

UNDERHOOD DETAILING KIT



All concurs correct hardware individually packed and labeled. Kits typically include two dozen common areas to detail under the hood..

Year	Part No.	List
65	C5ZB-UH	\$109. ⁹⁵ KI
66	C6ZB-UH	\$104. ⁹⁵ KI
67	C7ZB-UH	\$104. ⁹⁵ KI
68	C8ZB-UH	\$104. ⁹⁵ KI
69	C9ZB-UH	\$119. ⁹⁵ KI
70	D0ZB-UH	\$119. ⁹⁵ KI
71	D1ZB-UH	\$104. ⁹⁵ KI
73	D3ZB-UH	\$104. ⁹⁵ KI

CARBURETOR MOUNTING NUT



Exact copies, not off the shelf standards. Thin design nut like originals. Mounts carb to intake. 4 Piece Set.

Year	Part No.	List
64-73	MCN001	\$4. ⁹⁵ KI

BATTERY CLAMP BOLT



Bolt to secure the battery in the tray. See "Electrical" section for complete mounting kits.

Year	Part No.	List
67-70	D0AZ-10756-A	\$2. ⁵⁰ EA

CLUTCH FAN BOLT



4 piece set.

Year	Part No.	List
66-73	C50E-1804	\$6. ⁹⁵ SE

FAN SPACER BOLT KIT



Fits our 2-1/8" and 2-1/4" fan spacers. Available in "Cooling" section

Year	Description	Part No.	List
64-73	Silver zinc	379205-K	\$3. ⁹⁵ KI

COWL-HOOD GROUNDING STRAP



This piece is an exact reproduction. Brass contact strap with correct mounting screw.

Year	Part No.	List
67-68	C5AA-18870-A	\$5. ⁹⁵ EA

HEATER CABLE CLAMP BRACKET KIT



Secures cable to heater control assembly, heater plenum and heater box. Black oxide bracket with screw.

Year	Part No.	List
64-68	378897-S	\$2. ⁵⁰ SE

BREATHER HOSE CLAMP



Designed for any one-inch hose, this clamp can be used for the breather hose between the valve cover and air cleaner on 1964 - 1967 Mustangs.

Year	Part No.	List
60-67	C3AZ-18572-A	\$1. ⁵⁰ EA

INTAKE MANIFOLD BOLT KIT



Concours correct with the exact head markings. Not an off the shelf generic copy. These are 100% correct or your money back!

Year	Description	Part No.	List
67-68	390, 428	IMB-B8AE-475	\$31.95 ^{KI}
67	GT500	IMB-C3AE-493	\$44.95 ^{KI}
64-67	260, 289	IMB-C40E-478	\$24.95 ^{KI}
68-69	289, 302	IMB-C80E-479	\$24.95 ^{KI}
69-70	Boss 429	IMB-C9AE-1376	\$44.95 ^{KI}
69	351W	IMB-C90E-1131	\$24.95 ^{KI}
69-70	390, 428	IMB-C90E-476	\$34.95 ^{KI}
69	Boss 302	IMB-C9ZE-1306	\$74.95 ^{KI}
70-73	351 2V	IMB-D00E-1313	\$26.95 ^{KI}
70-73	302	IMB-D00E-1123	\$26.95 ^{KI}
70-73	351 Cleveland 4V	IMB-D00E-1321	\$26.95 ^{KI}
70	Boss 302	IMB-D0ZE-1320	\$74.95 ^{KI}
68	GT500	IMB-S8ME-477	\$41.95 ^{KI}

VALVE COVER BOLTS

These valve cover bolts come in either allen or hex head style. Sold in 24 piece sets.



64-73: Allen head, black
VCB-AB

List

\$5.95^{KI}



64-73: Allen head, Stainless
VCB-AS

List

\$6.50^{KI}



64-73: Hex head, zinc plated
VCB-HC

List

\$6.50^{KI}

VOLTAGE REGULATOR MOUNTING

KIT



3 piece kit. Correct screws to mount voltage regulator.

Year	Part No.	List
65-67	VRM-C5ZL-404	\$2.95 ^{KI}
68	VRM-C8ZL-406	\$2.95 ^{KI}

VOLTAGE REGULATOR SCREW CAP



Plastic caps used to cover sharp points on screws that mount voltage regulator.

Year	Part No.	List
64-66	CSZZ-10316-S	\$2.50 ^{PR}

CONCOURS VALVE COVER BOLT SET



A great addition to a concours engine. These exact copies feature details of the originals. All head

markings are correct. Not an off the shelf generic copy.

Year	Description	Part No.	List
64-73	170, 200, 250 6 cyl.	VCB-CODE-480	\$8.50 ^{KI}
64-73	Small block, Boss 302 w/ stamped steel covers	VCB-C20E-481	\$13.95 ^{KI}
65-68	Cobra valve covers "RBW"	VCB-S1ME-1438	\$13.95 ^{KI}
69-73	Plain head w/ washers	VCB-S9ME-1619	\$13.95 ^{KI}
70-73	351 Cleveland	VCB-D00E-482	\$18.95 ^{KI}
67-70	390, 427, 428	VCB-B8AE-339	\$18.95 ^{KI}
70-71	Boss 302, 351 w/ aluminum covers and Boss 351 "E" logo	VCB-D0ZE-483	\$34.95 ^{KI}
67-68	428 Shelby "RBW" logo	VCB-S7ME-310	\$38.95 ^{KI}
69-70	GT-350	VCB-S9MB-1619	\$13.95 ^{KI}
64-73	Hex head, cadium plated	VCB-HC-S	\$5.95 ^{EA}

STARTER BOLT



These are the real thing. Not just a generic bolt. Yes, judges do check these details. 2 piece set. Special 1/2" head.

Part No.	Year	Description	List
C8ZL-1410	65-73	Special 1/2" head	\$5.95 ^{KI}

SHOCK TOWER BOLT



Special bolts that slip into shock tower to retain shock tower cap.

Part No.	Year	Description	List
355471-SK	64-66	Set of 6, silver zinc	\$7.95 ^{KI}
378353-SK	67-73	Set of 6, black zinc	\$7.95 ^{KI}

TOP SHOCK MOUNT BOLT



These are the bolts that hold the top of the shock to the upper shock tower. Each bolt is 5/16" fine threads, zinc plated and

Concours correct. NOTE: These bolts will not fit 1967-73 cars that use coarse threads.

Year	Description	Part No.	List
64-66	Front Top	373406-SK	\$4.95 ^{KI}

SHOCK TOWER NUT



64-66 feature special hex nut with external star washer. Zinc plated.

Year	Description	Part No.	List
64-66	Set of 6	33923-SK	\$2.95 ^{KI}
67-73	Set of 6	33791-SK	\$3.50 ^{KI}

WIRING LOOM TIES



These wire loom ties are found through out the engine compartment. Black nylon. Complete kits

available, see "Electrical" section.

Year	Part No.	List
64-73	376914-S	\$0.50 ^{EA}

AFTERMARKET FENDER & BODY PARTS



Not concours correct head pattern, but very good looking. All 5/16-18 x 7/8 long. Aftermarket 5/16-18 x 7/8 inch long .

Year	Finish	Part No.	List
66 - 73	Black oxide finish	378178-DB	\$0.90 ^{EA}
66 - 73	Bright cadmium finish	378178-DC	\$0.95 ^{EA}
66 - 73	Polished stainless steel	378178-SS	\$1.75 ^{EA}



An exclusive from Scott Drake, our 1964-73 Mustang Under Hood

Hardware feature machined aluminum washers and stainless steel bolts. A beautiful accent to your Mustangs engine bay. Includes Washers and Bolts with 5/16" x 18 threads.

Year	Finish	Part No.	List
64 - 73	12 piece Underhood Billet Hardware	378178-BL-12	\$17.50 ^{SE}
66 - 73	24 piece Underhood Billet Hardware	378178-BL-24	\$34.95 ^{SE}

WE PROUDLY FEATURE AUTHENTIC MUSTANG REPRODUCTIONS FROM SCOTT DRAKE!



EXTERIOR HARDWARE

MASTER CHASSIS KIT



These kits are huge! Once again these are not generic off the shelf typical bolts. Each one is an exact copy from the original

equipment manufacturer. A typical kit would include the following: Accelerator bellcrank, rear axle retainers/rear brake plates, front brake plates, brake booster, brake cables, brake calipers, brake drums, brake hoses, spring perches, control arms, front crossmember, axle housing, differential carrier, drive-shaft, engine mounts, gas cap, gas tank, filler neck, idler arm, leaf spring front eye, master cylinder, parking brake control, pitman arm, proportioning valve, rag joint, front shocks, shock brackets, steering gear, steering linkage, strut rods, sway bar insulator brackets, transmission crossmember, transmission insulator and wheel cylinders. Remember only fasteners are included.

Year	Description	Part No.	List
65	289 High Performance, disc	MCK-C5ZS-DCHP	\$350 ⁰⁰ KI
65	260-289, disc	MCK-C5ZS-DCSB	\$335 ⁰⁰ KI
65	260-289, drum	MCK-C5ZS-DRSB	\$299 ⁹⁵ KI
65	170, 200, drum	MCK-C5ZS-DRSX	\$269 ⁹⁵ KI
66	289 High Performance, disc	MCK-C6ZS-DCSB	\$335 ⁰⁰ KI
66	289, drum	MCK-C6ZS-DRSB	\$299 ⁹⁵ KI
66	170, 200, drum	MCK-C6ZS-DRSX	\$269 ⁹⁵ KI
67	390, 428, disc	MCK-C7ZS-DCBB	\$349 ⁹⁵ KI
67	289 High performance, disc	MCK-C7ZS-DCSB	\$349 ⁹⁵ KI
67	289, drum	MCK-C7ZS-DRSB	\$324 ⁹⁵ KI
67	200, drum	MCK-C7ZS-DRSX	\$324 ⁹⁵ KI
68	390, 428, disc	MCK-C8ZS-DCBB	\$335 ⁰⁰ KI
68	289, 302, disc	MCK-C8ZS-DCSB	\$349 ⁹⁵ KI
68	289, 302, drum	MCK-C8ZS-DRSB	\$349 ⁹⁵ KI
68	200, drum	MCK-C8ZS-DRSX	\$349 ⁹⁵ KI
69	390, 428, disc	MCK-C9ZS-DCBB	\$379 ⁹⁵ KI
69	302, 351, disc	MCK-C9ZS-DCSB	\$374 ⁹⁵ KI
69	302, 351, drum	MCK-C9ZS-DRSB	\$349 ⁹⁵ KI
69	200, drum	MCK-C9ZS-DRSX	\$295 ⁰⁰ KI
69	250, drum	MCK-C9ZS-DRSX	\$349 ⁹⁵ KI
69	428, disc	MCK-C9ZS-HDBB	\$375 ⁰⁰ KI
69	Boss 429, disc	MCK-C9ZS-HDBG	\$399 ⁹⁵ KI
69	Boss 302, Boss 351, disc	MCK-C9ZS-HDSB	\$370 ⁰⁰ KI
70	Boss 429, disc	MCK-DOZD-HDBG	\$375 ⁰⁰ KI
70	302, 351, disc	MCK-DOZS-DCSB	\$349 ⁹⁵ KI
70	302, 351, drum	MCK-DOZS-DRSB	\$329 ⁹⁵ KI
70	200, drum	MCK-DOZS-DRSX	\$314 ⁹⁵ KI
70	250, drum	MCK-DOZS-DRSX	\$314 ⁹⁵ KI
70	428, disc	MCK-DOZS-HDBB	\$394 ⁹⁵ KI

Year	Description	Part No.	List
70	428, disc	MCK-DOZS-HDBB	\$394 ⁹⁵ KI
70	Boss 302, Boss 351, disc	MCK-DOZS-HDSB	\$349 ⁹⁵ KI
71	429, disc	MCK-D1ZS-DCBB	\$350 ⁰⁰ KI
71-73	302, 351, disc	MCK-D1ZS-DCSB	\$350 ⁰⁰ KI
71-73	250, disc	MCK-D1ZS-DCSX	\$335 ⁰⁰ KI
71-73	302, 351, drum	MCK-D1ZS-DRSB	\$335 ⁰⁰ KI
71-73	250, drum	MCK-D1ZS-DRSB	\$335 ⁰⁰ KI

MASTER BODY KIT



All concours correct. These new kits include all sheet metal attaching hardware necessary to properly reassemble a Mustang body.

Most kits include Battery tray, bumper guard-front, bumper guard rear, bumper guard mount brackets, bumper guard pads, cowl braces, door hinges, door latches, fenders, fender pillar brackets, fender extensions, fender splash shields, fender splash shield brackets, floorboard hole covers, grille, grille supports, headlamp doors, hood and hood hinges, hood bumper, hood latch and catch, hood latch support, quarter panel extensions, stone deflector, suspension bumper brackets-front, trunk latch and striker, trunk lid and hinges, valance front and valance rear. Also includes assembly instructions.

Year	Description	Part No.	List
64-65		MBK-C5ZB-MASTER	\$219 ⁹⁵ KI
66		MBK-C6ZB-MASTER	\$219 ⁹⁵ KI
67		MBK-C7ZB-MASTER	\$219 ⁹⁵ KI
68		MBK-C8ZB-MASTER	\$219 ⁹⁵ KI
69		MBK-C9ZB-MASTER	\$204 ⁹⁵ KI
70		MBK-DOZB-MASTER	\$204 ⁹⁵ KI
71		MBK-D1ZB-MASTER	\$204 ⁹⁵ KI
72		MBK-D2ZB-MASTER	\$204 ⁹⁵ SE
73		MBK-D3ZB-MASTER	\$204 ⁹⁵ SE
67	Shelby	MBK-S7MB-MASTER	\$239 ⁹⁵ SE
68	Shelby	MBK-S8MB-MASTER	\$219 ⁹⁵ KI
69-70	Shelby	MBK-S9MB-MASTER	\$219 ⁹⁵ KI

EXTERIOR TRIM SCREW KIT



Exterior screw kits include outside mirror, parking lamp lens, back up lamp lens, headlamp door and tail lamp screws.

Part No.	Year	List
ITS-65-EXT	64-66	\$10 ⁹⁵ KI
ITS-67-EXT	67-68	\$10 ⁹⁵ KI

EMBLEM BARREL CLIP



A must when re-mounting emblems. Correct in every way.

Year	Description	Part No.	List
64-73	Pin diameter range .184-.190 (large)	375480-S	\$0 ⁴⁰ EA
64-73	Pin range diameter .120-.130 (medium)	375890-S	\$0 ³⁰ EA
64-73	Pin range diameter .062-.072 (small)	378362-S	\$0 ³⁰ EA

TOP FENDER HARDWARE KIT



Our top fender hardware kit is a convenient way to get the right hardware in one package. 24 pieces. 12 black bolts and 12 J clips. Kit uses 378178-DB bolts.

Year	Part No.	List
64-68	378178-TFM	\$15 ⁹⁵ KI

SMALL FENDER & VALANCE BOLT



This bolt has a 1/4-20 thread and is 3/4 inch long from the head down. It is used several places throughout the car, but primarily in the front sheet metal such as the valance, headlamp assembly to fenders, etc.

Year	Part No.	List
64-73	43263-S BOLT	\$0 ⁵⁰ EA

FENDER TO COWL BOLT



Made of heavy gauge spring steel. Includes bolt and retainer.

Year	Part No.	List
65-66	378685-S2	\$3 ⁹⁵ EA

FENDER TO COWL NUT SET



Pair of captive nuts on stamped steel winged plates. Snaps into rocker. Very special nut hard to find.

Year	Part No.	List
64-70	359613-SK	\$6 ²⁵ KI



CONCOURS FENDER & BODY BOLTS

Authentic copies of the original. These are the most commonly used bolts on all Fords, virtually used throughout car but most visible on fenders.

Year	Part No.	Head	Marking head	Finish	List
5/16-18 x 15/16 inch long, 7/8 inch O.D.					
1965 - 67	378156-S2-HTS	HTS	External star washer	Phosphate & oil, black finish	\$1.00 ^{EA}
1965 - 67	378156-S2-HTS/R	HTS w/ rings	External star washer	Phosphate & oil, black finish	\$1.00 ^{EA}
1965 - 67	378156-S2-S	SEMS	External star washer	Phosphate & oil, black finish	\$1.00 ^{EA}
5/16-18 x 1 1/16 inch long, 7/8 inch O.D.					
1965 - 67	378178-S2-ANCH	ANCHOR	External star washer	Phosphate & oil, black finish	\$1.00 ^{EA}
5/16-18 x 1 inch long, 13/16 inch O.D.					
1966 - 67	378178-S2E	SEMS	Conical toothed disc washer	Phosphate & oil, black finish	\$1.20 ^{EA}
1968	378178-S7	S	Conical toothed disc washer	Cadmium & wax, silver	\$1.00 ^{EA}
1966 - 67	378178-S2-DITTO	DITTOS	Conical toothed disc washer	Phosphate & oil, black finish	\$1.20 ^{EA}
1968	378178-DS7	ANCHOR	Conical toothed disc washer	Cadmium & wax, silver	\$1.00 ^{EA}
1968	378178-S2	RBW	Conical toothed disc washer	Phosphate & oil, black finish	\$1.20 ^{EA}
5/16-18 x 1 1/4 inch long, 13/16 inch O.D.					
1966 - 67	378242-S2-SEMS	SEMS	Conical toothed disc washer	Phosphate & oil, black finish	\$1.20 ^{EA}
1/4-20 x 7/8 inch long, 3/4 inch O.D.					
1967 - 73	B-11598	N	Conical disc washer	Phosphate & oil, black finish	\$1.00 ^{EA}
1967 - 73	57030-S236	FLAG	Conical disc washer	Zinc dichromate, yellow/gold	\$1.25 ^{EA}
1/4-20 x 7/8 inch long, 3/4 inch O.D.					
1969 - 70	57039-S7	FLAG	Conical disc washer	Cadmium & wax, soft silver	\$1.00 ^{EA}
1969 - 70	57039-S36	FLAG	Conical disc washer	Zinc dichromate, yellow/gold	\$1.00 ^{EA}
1969 - 73	57039-S2	FLAG	Conical disc washer	Phosphate & oil, black finish	\$1.20 ^{EA}

J NUT FASTENER



Correct fasteners that are used under fender bolts. Fender bolts thread into J nuts. Also used on many other applications throughout the Mustang.

Year	Description	Part No.	List
64-73	5/16x18	379831-S	\$0.80 ^{EA}
64-73	1/4x20	43263-S NUT	\$0.75 ^{EA}

SERRATED FLANGE NUT



A 5/16x18 serrated flange nut that is used in several locations throughout.

Year	Part No.	List
64-73	34392-S	\$0.50 ^{EA}

BILLET GRILLE EMBLEM MOUNTING CLIPS



These steel clips are specially designed to mount the C5ZZ-16229-B Running Horse Fender Emblem to a billet grille.

Year	Part No.	List
64-11	C5ZZ-16229-BGMC	\$9.95 ^{PR}

FRONT VALANCE MOUNTING KIT



This kit is used to mount front valance to fenders, stone deflector and lower front cross member.

Year	Part No.	List
64-11	43263-SMK	\$10.95 ^{KI}

STONE DEFLECTOR MOUNTING KIT



Year	Description	Part No.	List
64-66	10 piece kit	SDM-C5ZB-119	\$11.95 ^{KI}
67-68	10 piece kit	SDM-C7ZB-208	\$14.95 ^{KI}

GRILLE MOUNTING CLIP



A must for holding the grille moulding in place. Made from tough ABS plastic. 1971-72 is a set of 5.

Year	Part No.	List
71-72	D1ZZ-8251-A	\$5.50 ^{SET}
73	D3ZZ-8251-A	\$1.95 ^{EA}

WE PROUDLY FEATURE AUTHENTIC MUSTANG REPRODUCTIONS FROM SCOTT DRAKE!



HEADLIGHT ADJUSTING KIT



Includes threaded adjusting stud and nylon insert. Nylon insert is slightly larger than O.E.M. and requires minimal filing for proper fit.

Year	Part No.	List
64-66	C3MY-13181/032K	\$2.50 _{KI}

GRILLE MOUNTING KIT



These are not just generic pieces. OE correct. Show quality.

Year	Description	Part No.	List
65	12 piece kit	C5ZB-8200-MK	\$7.95 _{KI}
66	16 piece kit	C6ZB-8200-MK	\$9.95 _{KI}
67	10 piece kit	C7ZB-8200-MK	\$7.95 _{KI}
68	10 piece kit	C8ZB-8200-MK	\$7.95 _{KI}
69-70	7 piece kit	C9ZB-8200-MK	\$8.95 _{KI}

HEADLIGHT ADJUSTING KIT



Includes threaded adjusting stud and nylon insert. Nylon insert is slightly larger than O.E.M. and requires minimal filing for proper fit.

Year	Part No.	List
64-66	C3MY-13181/032K	\$2.50 _{KI}

HEADLIGHT ASSEMBLY HARDWARE KIT

A complete kit to mount a headlight assembly to the fender, everything you need. Sold each, it takes two per car.



64-66
C5ZZ-13008-MK

List
\$14.00_{KI}



67-68
C7ZZ-13008-MK

List
\$18.95_{KI}



69: 1 side (2 kits required per vehicle)
C8AZ-13118/9-MK

List
\$9.95_{EA}

HEADLIGHT ADJUSTERS



Year	Part No.	List
69	C9AZ-13032-A	\$7.50 _{PR}

HEADLIGHT DOOR SCREW KIT



Special Phillips Head screw, exact copy. Made from rust proof stainless steel. 8 piece set.

Year	Part No.	List
64-66	378852-SK	\$4.95 _{SE}

HEADLIGHT ADJUSTING NUT



These are the nuts that are used to adjust the headlamp beam trajectory. It is also available in the headlamp

adjusting kit, Part # C5ZZ-13008-MK.

Year	Description	Part No.	List
64-66	Nut Only	C3MY-13181-A	\$3.95 _{EA}
64-66	Correct metal, nylon nut & screw	C3MY-13181-K	\$4.95 _{EA}

HEADLIGHT DOOR RETAINER CLIP KIT



Mounts on headlamp assembly, headlamp door screws attach to this clip. 8 piece set.

Year	Part No.	List
64-66	357033-SK	\$2.50 _{SE}

HOOD HINGE MOUNTING KIT



Year	Part No.	List
64-68	359662-SMK	\$6.50 _{KI}

LICENSE PLATE MOUNTING KIT



Kit includes 4 screws, 2 metal nuts, 2 self-threading plastic nuts and 2 anti-rattle bumper.

Year	Part No.	List
64-73	380707-SK	\$2.95 _{KI}

LICENSE PLATE NUT FASTENER



Self threading white plastic. Used in front and rear valances. Perfect match.

Year	Part No.	List
64-73	380707-S	\$0.50 _{EA}

MOLDING HARDWARE



We offer these complete hardware kits for your customer's convenience. Kits include high strength

backing plates and all necessary screws, clips, or rivets.

Year	Description	Part No.	List
64-66	Left or right	C5ZZ-6510182-K	\$18.95 _{KI}
67-68	LH	C7ZZ-6510182-KL	\$18.95 _{KI}
67-68	RH	C7ZZ-6510182-KR	\$18.95 _{KI}

BULK REAR VALANCE FASTENER



This is the correct one, not an after market product off the shelf, but made from our own tooling. Plated to

prevent rust. Kit includes nuts.

Year	Part No.	List
64-73	372719-S100-B	\$1.25 _{EA}

REAR VALANCE MOUNTING KIT



Rear Valance Hardware kit contains 2 clips and 2 nuts. New and improved tooling.

Year	Part No.	List
64-70	372719-S100	\$2.95 _{KI}

REAR VALANCE MOUNTING SET



Set contains 11 screws.

Year	Part No.	List
64-68	376525-SK	\$2.95 _{SE}

BACK UP LIGHT SPACER



Stamped steel and zinc plated. Mounts on backup lamp housing stud between rear valance and nut. 4 piece set. This unique

spacer is also used on 65-66 Fastback Louvers.

Year	Part No.	List
64-68	359972-S8	\$5.50 _{SE}

TAIL LIGHT BEZEL SCREW



Exact copy of the original. Features stainless steel construction.

Year	Description	Part No.	List
64-66	Set of 8	50398-SK	\$3.95 _{KI}

TAIL LIGHT HOUSING MOUNTING NUT



These hard to find nuts are concours correct and feature high-quality zinc plating. 64-66 pictured. 67-68 feature external lock washers like originals.

Year	Description	Part No.	List
64-66	Set of 8	359606-S8	\$5.95 ^{SE}
67-68	Set of 12	377523-S	\$4.95 ^{SE}

TAIL LIGHT RETAINING BOLT



Year	Description	Part No.	List
69-73	Does not fit 1970	382764-S	\$1.75 ^{EA}

FUEL PUMP MOUNTING KIT



Concours correct fasteners, mounts fuel pump to engine.

Year	Description	Part No.	List
64-73	6 cyl., 170,200,250	FPM-CODE-518	\$4.95 ^{KI}
64-73	Small Block 260,289,302,351W	FPM-C50E-519	\$4.95 ^{KI}

INTERIOR HARDWARE

INTERIOR FASTENER KIT



Now available from Scott Drake, Interior Assembly Fastener Kits! These comprehensive kits include almost every fastener

needed for your vehicle's interior. Each application within the kit is separately packaged so you know exactly where it goes, and most oval head sheet metal screws in our kits are stainless with chrome, black, or zinc finish. Concours correct.

Year	Description	Part No.	List
65-66	Fastback, standard	KIT-65Z-63A	\$149.95 ^{KT}
65-66	Fastback, deluxe	KIT-65Z-63B	\$149.95 ^{KT}
65-66	Coupe, standard	KIT-65Z-65A	\$90.00 ^{KT}
65-66	Coupe, deluxe	KIT-65Z-65B	\$90.00 ^{KT}
65-66	Convertible, standard	KIT-65Z-76A	\$90.00 ^{KT}
65-66	Convertible, deluxe	KIT-65Z-76B	\$90.00 ^{KT}
67	Fastback, standard	KIT-67Z-63A	\$129.95 ^{KT}
67	Fastback, deluxe	KIT-67Z-63B	\$149.95 ^{KT}
67	Coupe, standard	KIT-67Z-65A	\$90.00 ^{KT}
67	Coupe, deluxe	KIT-67Z-65B	\$107.00 ^{KT}
67	Convertible, Standard	KIT-67Z-76A	\$90.00 ^{KT}
67	Convertible, deluxe	KIT-67Z-76B	\$107.00 ^{KT}

Year	Description	Part No.	List
68	Fastback	KIT-68Z-63	\$129.95 ^{KT}
68	Coupe	KIT-68Z-65	\$90.00 ^{KT}
68	Convertible	KIT-68Z-76	\$90.00 ^{KT}
69	Fastback	KIT-69Z-63	\$125.00 ^{KT}
69	Coupe	KIT-69Z-65	\$107.00 ^{KT}
69	Convertible	KIT-69Z-76	\$109.95 ^{KT}
70	Fastback	KIT-70Z-63D	\$116.00 ^{KT}
70	Coupe	KIT-70Z-65D	\$107.00 ^{KT}
70	Convertible	KIT-70Z-76D	\$107.00 ^{KT}
71-73	Fastback, Deluxe	KIT-71Z-63L	\$107.00 ^{EA}

INTERIOR TRIM SCREW KIT



Convenient kits that are packaged for impulse sales. Skin packaging includes screw descriptions on front of card for extra convenience. Kit includes the basic

screws used on most interior restorations. All screws are brilliantly chromed plated. This kit contains pillar trim, kick panel, coat hooks, visor bracket, rear view mirror, door sill plates and windshield trim screws.

Year	Description	Part No.	List
64-66	Coupe	ITS-65-CP	\$9.95 ^{KI}
64-66	Convertible	ITS-65-CV	\$9.95 ^{KI}
65-66	Fastback	ITS-65-FB	\$9.95 ^{KI}
64-66	Deluxe	ITS-65-PO	\$9.95 ^{KI}
67-68	Coupe	ITS-67-CP	\$9.95 ^{KI}
67-68	Convertible	ITS-67-CV	\$9.95 ^{KI}
67-68	Fastback	ITS-67-FB	\$9.95 ^{KI}

ARM REST BASE TO DOOR PANEL SCREW



Cadmium plated truss head screws. Just like original. 4 Piece Set.

Year	Part No.	List
64-66	377905-S	\$2.95 ^{SE}

ARM REST RETAINING CLIPS



Very unique clips, exact copies of the originals.

Year	Part No.	List
64-66	BA-7024146-A	\$2.95 ^{PR}
67-68	C7AB-6224146-C	\$2.95 ^{PR}

ARM REST PAD TO BASE SCREW KIT



Attaches pad to chrome base. Black oxide. 4 piece set.

Year	Part No.	List
64-66	32930-SK	\$1.50 ^{KI}

DASH PANEL NUT



These are exact reproductions. Gold zinc plated. Almost too nice to hide behind the dash. Sold in sets of 8 pieces.

Year	Part No.	List
67-68	376642-S36	\$8.95 ^{SE}

DOOR SILL PLATE SCREW



Chrome plated oval head screw to hold sill plates in position.

Year	Description	Part No.	List
64-70	Bulk	376290-S	\$0.30 ^{EA}
64-68	Set of 18	376290-SK	\$4.50 ^{SE}
64-70	#8 heads #10 threads	376290-RK	\$1.95 ^{PR}

DASH MOLDING CLIP KIT

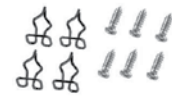

Dash Molding Clip Kit includes chrome screws and the special spring clips that secure the trim moldings to the dash. 10 pieces

Part No.	Year	List
C4DZ-6404561-K	64-65	\$5.95 ^{KI}

FIREWALL INSULATION FASTENERS



Year	Description	Part No.	List
64-73	Plastic replacement	357036-S100-P	\$3.50 ^{PR}
64-67	Metal Concours	C5Z2-6501691	\$17.95 ^{SE}
68-73	Rubber	C8Z2-6501691	\$3.95 ^{PR}

HORN RING RETAINER SCREW



Mounts plastic retainer to horn ring assembly. See "Electrical" section for

Horn Ring Retainers

Year	Part No.	List
64-68	51763-S	\$2.50 ^{KI}

DOOR LATCH SCREW



Correct screws with special star washers. Set of six.

Year	Description	Part No.	List
64-70	Set of 6	356782-S	\$3.75 ^{KI}

WE PROUDLY FEATURE AUTHENTIC MUSTANG REPRODUCTIONS FROM SCOTT DRAKE!



DOOR LATCH REINFORCEMENT KIT



Door Latch Reinforcement Kit Does Both Doors, 12 piece kit includes 6 bolts and 6 washers. See "Keys, Locks, & Latches" for repair plates.

Year	Part No.	List
64-70	CODB-3447	\$7.95 _{KI}

DOOR HINGE MOUNT KIT



OE looking bolts with built in washers. Black oxide finish.

Year	Description	Part No.	List
64-65	6, black, 3/8" threads	379043-SMK	\$5.95 _{KI}
66-68	6, black, 5/16" threads	380575-S2	\$4.95 _{KI}

INSIDE DOOR HANDLE & WINDOW CRANK SCREW

We have these exact reproductions made especially for us. You want to use right parts, not something "close". Chrome plated just like the originals. Sold in sets of 4.



65-66: Set of 4
379259-S

List

\$4.00_{SE}



67-70: Set of 4
381571-S

List

\$1.95_{SE}

DOOR GRILLE MOUNTING KIT



This kit is required to mount our dlx door grilles. 24 piece kit includes black screws and unique mounts.

Year	Part No.	List
67-68	C7ZN-3301	\$13.95 _{KI}

KICK PANEL SCREW



Chrome plated broad head screws to secure plastic kick panels in position. Kit does one car. Some cars only use 4 per car.

Year	Description	Part No.	List
64-68	Set of 6	350075-SK	\$2.50 _{SE}

SEAT RETAINING NUT



Another exact reproduction by Scott Drake. Painted to prevent rust. Color is dark red.

Year	Description	Part No.	List
64-70	Set of 4	378643-SK	\$6.95 _{SE}

SEAT TRACK BOLT



Year	Description	Part No.	List
64-70	Set of 4	379874-SK	\$4.95 _{SE}

DOOR GLASS RUN GUIDE



Prevent the glass from rattling in the door. White ABS plastic. 16 required for each car.

Year	Part No.	List
69-70	C9Z-6521496	\$3.95 _{EA}

SHIFTER, TRANS & DIFFERENTIAL HARDWARE

PRESSURE PLATE BOLT SET



These are the real thing, not just a generic copy.

Year	Description	Part No.	List
65-72	Set of 6	B7AT-3263	\$7.95 _{KI}

REAR END HOUSING NUT AND WASHER KIT



Original style, cadmium plated self-locking nuts. Kit includes 10 nuts and 10 washers.

Year	Description	Part No.	List
64-73	20 piece kit, silver cad. nuts	MDK001	\$18.95 _{KI}
68-73	20 piece kit, red nuts	MDK002	\$19.95 _{KI}

SHIFT COVER SCREW



Correct color and size.

Year	Description	Part No.	List
64-68	Automatic	52720-SK	\$2.50 _{KI}

TRANSMISSION MOUNT BOLTS



Year	Part No.	List
64-73	372821-S	\$5.95 _{PR}

AUTO TRANS TORQUE CONVERTER NUTS



Set of 4 unique flanged lock nuts. Year all automatic applications.

Year	Description	Part No.	List
64-73	Set of 4	377704-S	\$3.50 _{ST}

U-JOINT BOLT KIT



Concours correct kit. Includes 2 U-Bolts and 4 Lock Nuts.

Year	Description	Part No.	List
64-73	V8	C1AZ-4529-AK	\$8.95 _{KT}

SHIFTER SPRING

This is the tension spring that goes behind the trunnion at the base of the manual shifter. See "Transmission" section for shifter rebuild kits.



65-68: 3 speed
C2AZ-7208-C

List

\$3.95_{EA}



65-68: 4 speed
C2AZ-7208-D

List

\$2.50_{EA}

SHIFTER TRUNNION

These are the metal cups that are located at the end of the shifter to firm up a loose, wobbly shifter. Also sold in kits, see "Transmission" section.



64-68: 4 speed
C2AZ-7B125-A

List

\$3.95_{EA}



64-68: 3 speed
C2AZ-7B125-B

List

\$3.95_{EA}



64-69: 4 speed shifter interlock washer
CSZZ-7C318-A

List

\$14.95_{EA}

HEATING & A/C

AC & HEATER INTERIOR PACKAGE (ELECTRONIC CONTROLS)

Inside package air conditioning/heater assembly. Features electronic control package. Everything needed for the interior of the car except factory AC vents. Made for you to re-use your original dash vents. Passenger and Driver side vents also available from Scott Drake. Not a Complete Kit.



Year	Part No.	List
67	IP-1367M	\$769 ⁹⁵ KT
68	IP-1368M	\$769 ⁹⁵ KT

AC & HEATER INTERIOR PACKAGE (ELECTRIC CONTROLS & DASH BEZELS)

Inside package air conditioning/heater assembly. Features electronic control package and original dash bezels. Everything needed for the interior. 67-68 kit pictured.



Year	Part No.	List
64-66	IP-1368M	\$769 ⁹⁵ EA
67	IP-1267M	\$1,349 ⁹⁵ KT
68	IP-1268M	\$1,349 ⁹⁵ KT

HURRICANEAC & HEATER KIT (MANUAL CABLE CONTROLS)



The Hurricane is a complete system that replaces your original heater box and adds a modern, high efficiency A/C and heater/defroster in its place. It is a custom fit that utilizes all the factory firewall holes. No extra holes are needed. A new 3 speed switch neatly integrates into the factory heater control plate. Compact design allows easy installation and retains the glove box. 65-66 kit installed pictured above.

Year	Description	Part No.	List
65-66	260, 289 w/ alternator	CAP-1065M-289	\$1,209 ⁹⁵ KT
67-68	289 w/out power steering	CAP-1067M-289	\$1,219 ⁹⁵ KT
67-68	289 w/ power steering	CAP-1067M-289P	\$1,219 ⁹⁵ KT
67-68	6 cyl.	CAP-1067M-6	\$1,219 ⁹⁵ EA
69-70	302, 351W	CAP-1069M-302	\$1,209 ⁹⁵ EA
69-70	351 Cleveland	CAP-1069M-351C	\$1,249 ⁹⁵ EA
69-70	390, 428	CAP-1069M-390	\$1,289 ⁹⁵ EA

HURRICANE AC & HEATER KIT (ELECTRONIC CONTROLS)



Complete Heater A/C Conversion System with upgraded Electronic controls. Must be used in conjunction with your original A/C Dash Vents and Control Panel.

Designed to be used we 134a refrigerant. R12 Kit can be special ordered as well as a kit with Compressor bracket on opposite side than original. Additional charges may apply.

Year	Description	Part No.	List
67	Year non-AC w/ original 289 w/out power steering	CAP-1367M-289P	\$1,499 ⁹⁵ KT
67	Fits non-AC w/ original 289 w/ factory power steering	CAP-1367M-289P	\$1,499 ⁹⁵ EA
67	Fits non-AC w/ original 390 w/ factory power steering	CAP-1368M-390	\$1,399 ⁹⁵ KT
68	Fits non-AC w/ original 289-302 w/out power steering	CAP-1368M-289	\$1,399 ⁹⁵ KT
68	Fits non-AC w/ original 289-302 w/ factory power steering	CAP-1368M-289P	\$1,499 ⁹⁵ EA
68	Fits non-AC w/ original 390	CAP-1368M-390	\$1,399 ⁹⁵ KT

AC KIT



This complete package includes the underdash unit, drain tube, mounting brackets, compressor, all necessary hoses, receiver / dryer and condenser. This kit performs better than the original ever did and requires less horsepower to operate. 69-70 kit pictured.

Year	Description	Part No.	List
64-66	OE style for 6 cyl.	CAP-365M-6	\$1,030 ⁹⁵ EA
64-66	OE style for V8	CAP-365M-289	\$1,035 ⁹⁵ KT
67-68	289 w/ power steering	CAP-367M-289P	\$1,099 ⁹⁵ KT

HURRICANE AC & HEATER KIT (ELECTRONIC CONTROLS & DASH BEZELS)



Complete Heater A/C Conversion System with upgraded Electronic controls. Includes Factory A/C Control Panel & RH Dash Vents. Designed to be used we 134a

refrigerant. R12 Kit can be special ordered as well as a kit with Compressor bracket on opposite side than original. Additional charges may apply. 67-68 kit pictured.

Year	Description	Part No.	List
65-66	Fits 289 w/out generator	CAP-1165M-289	\$1,474 ⁹⁵ KT
65-66	Fits 200/6-cyl w/ out generator	CAP-1165M-6	\$1,474 ⁹⁵ KT
67	Fits non-AC w/ original 289 w/out power steering	CAP-1267M-289	\$1,699 ⁹⁵ KT
67	Fits non-AC w/ original 289 w/ factory power steering	CAP-1267M-289P	\$1,709 ⁹⁵ KT
67	Fits non-AC w/ original 390 w/ factory power steering	CAP-1267M-390	\$1,899 ⁹⁵ KT
68	Fits non-AC w/ original 289-302 w/out power steering	CAP-1268M-289	\$1,699 ⁹⁵ KT
68	Fits non-AC w/ original 289-302 w/ factory power steering	CAP-1268M-289P	\$1,709 ⁹⁵ KT
68	Fits non-AC w/ original 390	CAP-1268M-390	\$1,899 ⁹⁵ KT

**WE PROUDLY FEATURE AUTHENTIC MUSTANG
REPRODUCTIONS FROM SCOTT DRAKE!**



CONDENSER HOSE GROMMET

These grommets protect the condenser hoses as they pass through the radiator support on earlier Mustangs. Sold as a set of two.



64-66
378264S/379075S

List
\$7.95 PR



67-68
C7Z-19819

List
\$2.50 PR



69-70
C9Z-19819

List
\$2.50 PR

CONDENSER



Exact reproduction of the original aluminum serpentine condenser. The original material and construction design

is absolutely mandatory for proper system function and to prevent engine over-heating.

Year	Part No.	List
64-66	C5Z-19712-A	\$219.95 EA
67-68	C7Z-19712-A	\$239.95 EA
69-70	C9Z-19712-A	\$239.95 EA
71-73	D1Z-19712-A	\$244.95 EA

CONDENSER MOUNTING BRACKET



Painted black to stop corrosion. Four special brackets used to mount condenser.

Year	Part No.	List
64-66	C5Z-198594-R	\$24.95 KI

COMPRESSOR CONVERSION KIT



Update your factory AC system with this compressor conversion kit. Modern rotary compressor and custom hoses provide

a neat, clean underhood appearance. Kits include mounting brackets and hardware. Increase engine performance, gas mileage while eliminating vibration and belt noise.

Year	Description	Part No.	List
64-65	V8, R134a	50-3065	\$399.95 KT
64-65	289, R12	50-3065R12	\$437.50 KT
66	289, R134a	50-3066	\$385.95 KT
67	289, R134a	50-3067	\$529.95 KT
67	289, R12	50-3067R12	\$529.95 KT
68	V8, R134a	50-3068	\$399.95 KT
67-68	67-390, 68-289, 390, R12	50-3068R12	\$419.95 KT
69-70	302, R134a	50-3069	\$425.00 KI
69-70	302, R12	50-3069R12	\$425.00 KT
64-65	6 cyl., R134a	50-3165	\$466.95 KT
64-65	6 cyl., R12	50-3165R12	\$419.95 KT
66	6 cyl. R134a	50-3166	\$419.95 KT
66	6 cyl., R12	50-3166R12	\$399.95 KT
67	6 cyl., R134a	50-3167	\$515.95 KT
68	6 cyl., R12	50-3168R12	\$399.95 KT
69-70	6 cyl., R134a	50-3169	\$399.95 KT
69-70	6 cyl., R12	50-3169R12	\$425.00 KT
71-73	6 cyl., R134a	50-3171	\$479.95 KT
71-73	6 cyl., R12	50-3171R12	\$425.00 KT

UNDERHOOD PERFORMANCE / COMPRESSOR CONVERSION KIT



These kits include our popular Sanden style compressor & bracket, Super-Kool condenser with factory style drier,

new AC hoses and compressor safety switch. Maximize AC performance, increase engine horsepower, and improve gas mileage!

Year	Description	Part No.	List
65	V8	50-0012	\$589.95 KT
66	V8	50-0013	\$589.95 KT
66	200	50-0014	\$669.95 KT
66	200	50-0015	\$669.95 KT
67	SB	50-0016	\$774.95 EA
65	200	50-0017	\$679.95 KT
68	SB & BB	50-0018	\$599.95 KT
68	200	50-0019	\$599.95 KT
69-70	V8	50-0020	\$589.95 KT
69-70	6 cyl.	50-0021	\$589.95 KT

HIGH PERFORMANCE CONDENSER DRYER KIT

Includes OEM style receiver drier and mounting bracket for easy installation into original factory locations. New design technology incorporates a high heat-rejection, low refrigerant and air pressure drop as compared to the original condensers.

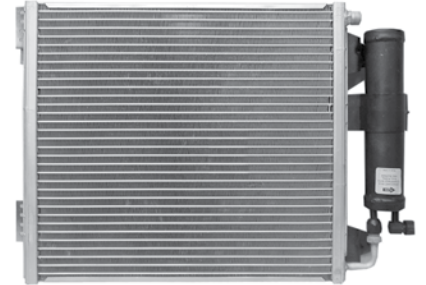

Year	Part No.	List
64-66	C5Z-19712-HPK	\$284.95 KT
67-68	C7Z-19712-HPK	\$272.50 KT
69-70	C9Z-19712-HPK	\$274.95 KT

LIQUID LINE HOSE ASSEMBLY



Connects to filter dryer outlet and extends through radiator core support.

Year	Part No.	List
64-66	C5Z-19837-A	\$20.95 EA

QUICK DISCONNECT FITTING

Manufactured by the original maker to the original specifications. Features concour markings stamped into fitting.



67-73: Male/Female
C7Z-198596-M/F

List
\$34.95 KI

COMPRESSOR CLUTCH BRUSHES



These are exact reproductions made from the original tooling.

Year	Part No.	List
64-70	C5Z-2979	\$40.95 KI

SERVICE VALVE



Fits on top of compressor. Exact copy. For aluminum valve cap see below. Aftermarket plastic cap

included. #8 are smaller and are the discharge hose, #10 is the larger size for the suction side of hose.

Year	Description	Part No.	List
64-66	Flare/Rotolock, discharge	C5ZZ-19752-A	\$26.95 ^{EA}
67-68	Flare/Rotolock, suction	C7ZZ-19752-A	\$26.95 ^{EA}
69	O-ring/Rotolock, discharge	C9ZZ-19752-D	\$26.95 ^{EA}
69	O-ring/Rotolock, suction	C9ZZ-19752-S	\$26.95 ^{EA}
70-73	O-ring/Tube-O, discharge	D1ZZ-19752-D	\$26.95 ^{EA}
70-73	O-ring/Tube-O, suction	D1ZZ-19752-S	\$26.95 ^{EA}

SERVICE VALVE CAPS



Aluminum caps which fit on the service valves, these are exact copies. A must for any detailed engine compartment.

Year	Part No.	List
64-73	C5ZZ-19752-C	\$19.95 ^{KI}

AIR CONDITIONER HOSE STRAPS



Holds A/C hose from cowl braces.

Year	Part No.	List
67-70	C7ZA-430	\$21.95 ^{SE}

SIGHT GLASS HOSE



High quality US made hose. Not exact copy of original but great for daily drivers.

Year	Description	Part No.	List
64	6 and V8	C5ZZ-19837-C	\$64.95 ^{EA}
67-68	6 and V8 w/ 90 degree fitting	C7ZZ-19837-A	\$79.95 ^{EA}
69-70	6 and V8	C9ZZ-19837-A	\$82.95 ^{EA}
70-73	6 and V8	D1ZZ-19837-A	\$82.95 ^{EA}

SUCTION HOSE



Constructed in original Ford style black thermoplastic material with nylon barrier. All hose assemblies are built compliant for R-12 or 134a refrigerants.

Year	Description	Part No.	List
64-65	V8, concours	C5ZZ-19864-8	\$57.95 ^{EA}
64-65	6 cyl., concours	C5ZZ-19867-6	\$74.95 ^{EA}
66	6 cyl., concours	C6ZZ-19864-6	\$66.95 ^{EA}
66	V8, concours	C6ZZ-19864-8	\$62.95 ^{EA}
66	V8, economy	C6ZZ-19864-8R	\$38.95 ^{EA}
67-68	6 cyl., concours	C7ZZ-19864-6	\$69.95 ^{EA}
67-68	V8, concours	C7ZZ-19864-8	\$69.95 ^{EA}
69-70	V8, concours	C9ZZ-19864-8	\$89.95 ^{EA}
71-73	V8, concours	D1ZZ-19864-8	\$114.95 ^{EA}

ALUMINUM LIQUID LINE



Connect to 90 degree liquid fitting at bottom of radiator core support and climbs shock tower to connect to sight glass hose.

Year	Part No.	List
64-66	C5ZZ-19837-B	\$44.95 ^{EA}

AIR CONDITIONER DRAIN HOSE



Molded rubber flex hose, just like original. New by Drake!

Year	Part No.	List
65-68	C8TZ-19858-A	\$12.50 ^{EA}

DISCHARGE HOSE



Concours high pressure hoses with correct authentic looking fittings. Made in the U.S.A. Hoses need replacing when they

show dry rot and cracking. Check crimped sleeves to hose for looseness by twisting fitting.

Year	Description	Part No.	List
64-66	V8, concours	C5ZZ-19972-8	\$52.95 ^{EA}
67-68	6 cyl., concours	C7ZZ-19972-6	\$82.95 ^{EA}
67-68	V8, concours	C7ZZ-19972-8	\$69.95 ^{EA}
69-70	V8, concours	C9ZZ-19972-8	\$69.95 ^{EA}
71-73	6 cyl., concours	D1ZZ-19972-6	\$70.95 ^{EA}
71-73	V8, concours	D1ZZ-19972-8	\$74.95 ^{EA}

FILTER DRYER



Exact replacement to original dryer. Dryer removes moisture and should be changed anytime system is recharged. It is

the life of your system. Stainless steel filter element. Filter stops contaminants from clogging expansion valve.

Year	Part No.	List
64-66	C4AZ-19959-B	\$56.95 ^{EA}
67-68	C7ZZ-19959-A	\$56.95 ^{EA}
69-70	C9ZZ-19959-A	\$69.95 ^{EA}
71-73	D1ZZ-19959-A	\$74.95 ^{EA}

DRYER MOUNTING BRACKET



Made by Scott Drake. Exact detail. Painted flat black. Mounting hardware included.

Year	Part No.	List
64-66	C5ZZ-19838-A	\$10.95 ^{SE}

EVAPORATOR



All new high output coils with more tubing passes makes these evaporators perform much better than

the original coils. New copper tube coils eliminate corrosion problem that plague aluminum versions.

Year	Description	Part No.	List
64-65	Factory under dash	C5ZZ-19860-A	\$249.95 ^{EA}
66	Factory under dash	C6ZZ-19860-A	\$249.95 ^{EA}
67-68		C7ZZ-19860-A	\$275.95 ^{EA}
71-73		D1ZZ-19860-A	\$294.95 ^{EA}

EXPANSION VALVE



Year	Part No.	List
64-66	C5ZZ-19849	\$69.95 ^{EA}
67-68	C7ZZ-19849	\$92.50 ^{EA}
69-70	C9ZZ-19849	\$89.95 ^{EA}
71-73	D1ZZ-19849	\$79.95 ^{EA}

FIREWALL AIR CONDITIONER HOSE GROMMET



Year	Part No.	List
64-66	C5ZZ-198588-A	\$4.95 ^{EA}

WE PROUDLY FEATURE AUTHENTIC MUSTANG REPRODUCTIONS FROM SCOTT DRAKE!



FIREWALL GROMMET BRACKET



Painted black to prevent corrosion.

Part No.	Year	List
CSZZ-19B589-A	64-66	\$31 ⁹⁵ EA

IDLER BEARING REPAIR KIT



Repair your own idler bearings. Includes dust cover.

Year	Part No.	List
64-70	CSZZ-2990-A	\$50 ⁹⁵ EA

IDLER PULLEY AND BRACKET



Quality rebuilds, core not required.

Year	Description	Part No.	List
65-66	Adjustable	CSZZ-8678-B	\$189 ⁹⁵ EA
65-66	Non-adjustable	CSZZ-8678-C	\$94 ⁹⁵ EA
68	Adjustable	C8ZZ-8678-A	\$64 ⁹⁵ EA

COMPRESSOR COVER



This cover plate bolts to the top of the original A/C compressor to dress up the engine compartment.

A nice match to our Aluminum Finned Valve Covers. Features Cobra or Mustang logo or plain. Available in satin or polished. Mounting hardware included.

Year	Description	Part No.	List
64-73	Cobra, satin	CSZZ-19703-CS	\$45 ⁹⁵ EA

COMPRESSOR COVER



This cover plate bolts to the top of the original A/C compressor to dress up the engine compartment.

A nice match to our Aluminum Finned Valve Covers. Features Cobra or Mustang logo or plain. Available in satin or polished. Mounting hardware included.

Year	Description	Part No.	List
64-73	Mustang, polished	CSZZ-19703-MP	\$45 ⁹⁵ EA
64-73	Mustang, satin	CSZZ-19703-MS	\$45 ⁹⁵ EA

COMPRESSOR COVER



This cover plate bolts to the top of the original A/C compressor to dress up the engine compartment.

A nice match to our Aluminum Finned Valve Covers. Features Cobra or Mustang logo or plain. Available in satin or polished. Mounting hardware included.

Year	Description	Part No.	List
64-73	Plain, polished	CSZZ-19703-PP	\$45 ⁹⁵ EA
64-73	Plain, satin	CSZZ-19703-PS	\$45 ⁹⁵ EA

SANDEN COMPRESSOR MOUNT KIT



This is the kit you will need to install a Sanden compressor on your original York compressor bracket.

Year	Part No.	List
64-73	CSZZ-2882-SCMK	\$74 ⁹⁵ KI

COMPRESSOR ADJUSTER



Year	Description	Part No.	List
65-67	6 cyl.	CSZZ-7105-A	\$22 ⁹⁵ EA

BYPASS HOT WATER ELBOW



These beautiful reproductions replace rusty and corroded originals.

Year	Description	Part No.	List
65	6 cyl	8M-18599	\$11 ⁹⁵ EA



Year	Description	Part No.	List
64-68	6 Cyl silver zinc	C20Z-18599-B	\$22 ⁹⁵ EA



Year	Description	Part No.	List
64-73	Small block, silver zinc	C6AZ-18599-S	\$16 ⁹⁵ EA
64-73	Small block, chrome	C6AZ-18599-C	\$21 ⁹⁵ EA
64-73	Small block, gold zinc	C6AZ-18599-B	\$16 ⁹⁵ EA



Year	Description	Part No.	List
67-68	Big block, gold zinc	C8AZ-18599-A	\$24 ⁹⁵ EA
67-68	Big block, chrome	C8AZ-18599-C	\$29 ⁹⁵ EA



Year	Description	Part No.	List
69-70	Boss 302, w/water restrictor, silver zinc	C9ZZ-18599-A	\$39 ⁹⁵ EA



Year	Description	Part No.	List
69-70	428, silver zinc	DOAZ-18599-B	\$39 ⁹⁵ EA



Year	Description	Part No.	List
69-73	351, 390, silver zinc	DOAZ-18599-A	\$24 ⁹⁵ EA
70-71	351, 390, chrome	DOAZ-18599-C	\$29 ⁹⁵ EA

HEATER CONTROL VALVE

This is used on cars equipped with factory Air Conditioning to stop the flow of warm coolant when AC is on. Not exact replacement.



67-68: OEM type
C7ZZ-18495-A

List
\$66⁹⁵ EA



69-73
D4AZ-18495-A

List
\$38⁹⁵

WATER VALVE BRACKET



Exact reproduction with zinc dichromate finish.

Year	Part No.	List
67-68	C7ZZ-18A635-A	\$25 ⁹⁵ EA

CPNCOURS HEATER HOSE BYPASS

CLAMPS



Concours set of 6 clamps stamped 2-66

Year	Part No.	List
66-68	C0AZ-8287-K	\$8 ⁹⁵ SE

HEATER CORE TO CONTROL VALVE

HOSE



Both ends have 90 degree molded ends. Attaches heater core to water control valve. AC cars only

Year	Part No.	List
67-68	C7ZZ-18472-CVAC	\$29 ⁹⁵ EA
69-73	C9ZZ-18472-CVAC	\$29 ⁹⁵ EA

HEATER HOSE KIT



Generic replacement hoses are American made. Black hose includes four original style post-type clamps.

Year	Description	Part No.	List
64-68	Generic	C5ZZ-18472-K	\$19 ⁹⁵ KI

SILICONE HEATER HOSE KIT



New by Scott Drake, these 1964-68 Mustang Heater Hoses are a perfect match to Drakes Silicone Radiator

Hose Sets (Mustang: C5ZE-8260/86-BK and C5ZE-8260/86-BK. Featuring an orange silicone interior that is wrapped in black silicone to ensure a long lasting hose that also has a higher resistance to bursts of pressure.

Year	Description	Part No.	List
64-68	Silicone	C5ZZ-18472-BLK	\$45 ⁹⁵ PR

HEATER HOSE



These are the exact copies, approved by Mustang Club of America. They feature the correct grooves running

the length of the hose, correct colored stripe and part numbers, air conditioned cars have a 90 degree bend on one end of the hose when appropriate. Colored markings are very durable and don't come off easily. Below part numbers are for our reference only and do not reflect part numbers on actual hoses.

Year	Description	Part No.	List
64-68	64-early 68, white stripe	C5ZZ-18472-W	\$21 ⁹⁵ PR
70-73	W/out AC, yellow stripe	C5ZZ-18472-Y	\$23 ⁹⁵ EA
67-68	67-early 68 w/ AC, white stripe	C7ZZ-18472-ACW	\$57 ⁹⁵ PR
68	After 2-1-68 w/ AC, red stripe	C8ZZ-18472-ACR	\$57 ⁹⁵ PR
68	All After 2-1-68, red stripe	C8ZZ-18472-R	\$42 ⁹⁵ PR
69	W/ AC, red stripe	C9ZZ-18472-ACR	\$57 ⁹⁵ PR
69	Red stripe	C9ZZ-18472-R	\$42 ⁹⁵ PR
70	After 2-1-70 w/ AC, yellow stripe	D0ZZ-18472-BACY	\$57 ⁹⁵ PR
70	After 2-1-70, yellow stripe	D0ZZ-18472-BY	\$42 ⁹⁵ PR
71	W/ AC, yellow stripe	D1ZZ-18472-ACY	\$49 ⁹⁵ PR
71-73	Yellow stripe	D1ZZ-18472-Y	\$42 ⁹⁵ PR
72	Yellow stripe	D2ZZ-18472-Y	\$42 ⁹⁵ PR

SHOW QUALITY HEATER HOSE KIT



These show quality hoses include original style 5/8-inch inside diameter ribbed hose with 1/4" wide white stripe, plus four post-type band clamps.

Year	Description	Part No.	List
64-66	Show quality	C5ZZ-18472-WK	\$27 ⁹⁵ KI

HEATER HOSE FIREWALL GROMMET



Protect Heater Hose where it passes through Firewall from getting out.

Year	Part No.	List
69-70	382745-S	\$12 ⁹⁵ PR

FIREWALL HEATER HOSE PLUG



Rubber plug for heater core or a/c holes on non-air conditioned cars.

Year	Part No.	List
67-68	377678-S2	\$1 ⁵⁰ PR

BRASS HEATER CORE



Our heater cores are the finest available anywhere for any price. Constructed from corrosion resistant copper and brass. A great

buy for anyone needing to make repairs to this vital part.

Year	Description	Part No.	List
64-68	W/out AC	C5DZ-18476-A	\$74 ⁹⁵ EA
69-70	W/out AC	C9ZZ-18476-A	\$74 ⁹⁵ EA
67-73	W/ AC	C9ZZ-18476-B	\$69 ⁹⁵ EA
71-73	W/out AC	D1ZZ-18476-B	\$69 ⁹⁵ EA

ALUMINUM HEATER CORE



This is the same basic design as the original but the aluminum construction will allow better heating.

Not a generic replacement that does not fit like some others. Made to our specifications. 1969-73 cars requires trimming the heater core end caps for proper fitment.

Year	Desc	Part No.	List
64-68	W/out AC	C5DZ-18476-AL	\$40 ⁹⁵ EA
69-70	W/out AC	C9ZZ-18476-AL	\$45 ⁹⁵ EA
67-73	W/ AC	C9ZZ-18476-BAL	\$44 ⁹⁵ EA

HEATER CORE END CAP



These foam rubber end caps protect the core from damage due to excessive vibration. Prevents rattles and improves heater

performance with better sealing of the box.

Year	Description	Part No.	List
65-68	W/out AC	C5ZZ-18500-C	\$9 ⁹⁵ SE
67-73	W/ AC	C5ZZ-18500-C	\$9 ⁹⁵ SE

WE PROUDLY FEATURE AUTHENTIC MUSTANG REPRODUCTIONS FROM SCOTT DRAKE!



HEATER BLOWER MOTOR



High quality replacement part at a reasonable price.

Year	Description	Part No.	List
64-65	2-speed w/3-wires	CODZ-18527-A	\$62. ⁹⁵ EA
65-68	3-speed motor, will not work w/ early 65 cars w/ 3 wired, 2 speed motor	CSZZ-18527-B	\$49. ⁹⁵ EA
65-68	3-speed motor w/ squirrel cage (fan)	CSZZ-18527-K	\$70. ⁹⁵ EA
67-73	W/AC	C7ZZ-18527-A	\$64. ⁹⁵ EA
67-73	W/out AC	C9ZZ-18527-A	\$50. ⁹⁵ EA

HEATER BLOWER MOTOR TO FIREWALL NUT



Concours correct nuts with sealer.

Year	Part No.	List
64-73	370546-S	\$3. ⁵⁰ ST

HEATER SEAL KIT



Everything you need to completely reseal the heater system and make it perform at top efficiency.

Kit includes all foam seals and rubber gaskets required for the entire heater system. Don't forget heater core end caps.

Year	Description	Part No.	List
64-66	All	CSZZ-18500-A	\$14. ⁹⁵ KI
67-68	W/out AC	C7ZZ-18500-A	\$14. ⁹⁵ KI
67-68	W/AC	C7ZZ-18500-B	\$14. ⁹⁵ KI
69-70	W/AC	C9ZZ-18500-A	\$14. ⁹⁵ KI
69-70	W/out AC	C9ZZ-18500-B	\$14. ⁹⁵ KI
71-73	W/AC	D1ZZ-18500-A	\$19. ⁹⁵ KI

HEATER BOX ASSEMBLY



Complete heater box assembly, features fiberglass box and steel stamped air chamber whirl cage. Motor is not included.

Year	Description	Part No.	List
64-65	2 speed	CSZZ-18A542-K	\$209. ⁹⁵ EA
65-66	3 speed	C6ZZ-18A542-K	\$209. ⁹⁵ EA
67-68	3 speed	C7ZZ-18A542-K	\$209. ⁹⁵ EA
69-70	W/ gasket and clips	C9ZZ-18A542/3-A	\$279. ⁹⁵ EA

SHIFTER TRUNNION

These are the metal cups that are located at the end of the shifter to firm up a loose, wobbly shifter. Also sold in kits, see "Transmission" section.



64-68: 4 speed
C2AZ-7B125-A

List

\$3.⁹⁵ EA



64-68: 3 speed
C2AZ-7B125-B

List

\$3.⁹⁵ EA



64-69: 4 speed shifter interlock washer
CSZZ-7C318-A

List

\$14.⁹⁵ EA

HEATER BOX CASE CLAMP



Special steel clamps that hold both halves of the heater box together.

Year	Part No.	List
64-68	CODF-19A779-A	\$2. ⁵⁰ EA

DEFROSTER CONTROL CABLE



These parts are exactly like the originals. They feature correct cable covers, color coding, wire type and ends.

Year	Part No.	List
64-66	C4DZ-18548-A	\$7. ⁹⁵ EA

HEATER CONTROL CABLE



These parts are exactly like the originals. They feature correct cable covers, color coding, wire type and ends

Year	Description	Part No.	List
64-66	Defroster	C4DZ-18548-A	\$7. ⁹⁵ EA
64-66	Heat, Temperature and Defrost	CSZZ-18518-52-K	\$19. ⁹⁵ SE
64-66	Temperature	CSZZ-18518-B	\$7. ⁹⁵ EA
64-66	Heat control	CSZZ-18552-A	\$7. ⁹⁵ EA
67-68	W/out AC	C7ZZ-18518-A	\$25. ⁹⁵ KI
67-68	W/AC	C7ZZ-18518-B	\$18. ⁵⁰ EA
69-73	W/out AC	D1ZZ-18518-A	\$21. ⁹⁵ SE

HEATER INLET GASKET



This gasket seals the fresh air tube in the cowl to the heater box inlet on 1964 through 1970 Mustangs.

Year	Part No.	List
64-70	CSZZ-18A569-A	\$3. ⁹⁵ EA

HEATER PLENUM

Our replacement heater plenums are molded from virgin ABS plastic for good looks and durability. Cable clamp and screw are attached, and inner door has closed cell foam bumpers installed.



Year	Description	Part No.	List
64-68	View box packaging	CSZZ-18471-A	\$24. ⁹⁵ EA

DEFROSTER DUCT

A nice reproduction. 67-68 features wire mesh screen like original.



64-66: Pair w/ clips
CSZZ-18490-A

List

\$7.⁹⁵ PR



67-68: w/out AC
C7ZZ-18490-R (RH)
C7ZZ-18490-L (LH)

List

\$34.⁹⁵ EA

DEFROSTER DUCT CLIP



These clips hold the defroster outlet nozzles to the dashboard. Four (one set) are required for a complete installation.

Year	Description	Part No.	List
64-70	Set of 4	372850-S	\$2. ⁵⁰ SE

DEFROSTER DUCT KIT



Complete kit includes two hoses with outlet ducts attached, and installation clips.

Year	Part No.	List
64-66	CSZZ-18490-K	\$19. ⁹⁵ KI

SHOP WITH CONFIDENCE! WE OFFER SUPERIOR-QUALITY PARTS FOR ALL YOUR MUSTANG RESTORATION NEEDS.

DEFROSTER HOSE WITHOUT LOCKS



We also sell defroster hoses individually. Hose is authentic flex style, made from original type polypropylene coated fabric. Available with or without cam-locks which will provide a quick secure installation.

Year	Part No.	List
64-70	B5A-18556-C	\$13. ⁹⁵ PR

DEFROSTER HOSE WITH LOCKS



These 1964-68 Mustang defroster hoses, from Scott Drake, are authentic flex style made from original type polypropylene coated fabric. This version comes complete with cam-lock clamps for a quick and secure installation.

Year	Part No.	List
64-70	CSZZ-18556-A	\$19. ⁹⁵ PR

HEATER RESISTOR ASSEMBLY



Our new 67-73 versions are now made by Scott Drake. These 3-speed A/C-Heater Resistors are made from original factory specs and are a direct replacement for your old resistors!

Year	Description	Part No.	List
65-67	3 speed	C20A-18591-A	\$16. ⁹⁵ EA
67	3 speed w/ factory AC	C7ZZ-19A706-A	\$18. ⁹⁵ EA
68-73	3 speed w/ factory AC	C8ZZ-19A706-A	\$18. ⁹⁵ EA

HEATER JUMPER HARNESS



Connects heater switch to engine gauge harness which plugs into heater motor.

Year	Description	Part No.	List
64-65	2 speed only	CSZZ-18570-JMP	\$48. ⁹⁵ EA

HEATER BLOWER MOTOR FAN SWITCH



Year	Description	Part No.	List
65-66	3-speed	CSZZ-18578	\$65. ⁹⁵ EA
64-65	2 speed, before 4/1/65	C4DZ-18578	\$58. ⁹⁵ EA
67	W/o AC	C7ZZ-19986	\$68. ⁹⁵ EA
68	W/o AC	C8ZZ-19986	\$68. ⁹⁵ EA
67	W/AC	C7ZZ-19986-AC	\$68. ⁹⁵ EA
68	W/AC	C8ZZ-19986-AC	\$68. ⁹⁵ EA

AIR CONDITIONER BLOWER SWITCH



Air conditioning blower switch (five terminal) for 1966 Mustang.

Year	Description	Part No.	List
66	5 terminal	C6ZZ-19986	\$42. ⁵⁰ EA

AIR CONDITIONER FEED HARNESS



Plugs into main A/C unit under dash, connects into back of ignition switch then, runs through firewall to compressor switch.

Year	Part No.	List
64-66	CSZZ-19800-ACF	\$27. ⁹⁵ EA
67	C7ZZ-19800-ACF	\$39. ⁹⁵ EA

AIR CONDITIONER THERMOSTAT



Made by original supplier. Stops evaporator coil from freezing up.

Part No.	Year	List
CSZZ-19A671-A	64-66	\$32. ⁹⁵ EA
C7ZZ-19A671	67-73	\$53. ⁹⁵ EA

HEATER DASH PLATE



Our reproduction heater dash plate is a fine pressure die-cast zinc unit made to Scott Drake's high standards. Excellent chrome plating on face. Includes mounting studs and nuts. See Audio section for 69-70 Radio/Heater Dash Plate. Special retaining bracket available see part C40A-18580-A.

Year	Description	Part No.	List
64-66	Chrome	CSZZ-18A651	\$19. ⁹⁵ EA
64-66	Satin	CSZZ-18A651-S	\$21. ⁹⁵ EA

DELUXE HEATER DASH PLATE & KNOB KIT



This complete kit includes everything you need to replace the heater control plate and knobs on 64-66 Mustangs. Features concours correct heater plate and knobs in show quality chrome. Correct threaded studs, lock nuts and special retaining plates are included for a hassle free installation.

Year	Description	Part No.	List
64-66	Chrome	CSZZ-18A651-KIT	\$43. ⁹⁵ KIT

HEATER DASH RETAINERS



A very special retainer required to install heater dash plate.

Year	Description	Part No.	List
64-66	Zinc	C40A-18580-A	\$7. ⁹⁵ PR

HEATER & AC CONTROL KNOBS

These exact reproductions are a great finishing touch. Made from die cast zinc and heavily chrome plated for durability. Black and chrome lettering on 64-68 versions is crisp and clear. 69-70 are chrome plated plastic like original.



64-66: Heater, chrome
CSDZ-18519-K

List
\$16.⁹⁵ SE



64-66: Heater, satin
CSDZ-18519-KS

List
\$17.⁹⁵ SE



67: AC
C7ZZ-18519-ACK

List
\$24.⁹⁵ SE



67: Non A/C
C7ZZ-18519-AK

List
\$24.⁹⁵ SE



68: AC
C8ZZ-18519-ACK

List
\$24.⁹⁵ SE



68: Non A/C
C8ZZ-18519-AK

List
\$24.⁹⁵ SE



69-70: All
C9ZZ-18519-A

List
\$14.⁹⁵ SE

AC VENT

Replacement air conditioning vents for the instrument panel.



67-68: RH side
C7ZZ-19893-A

List
\$172.⁵⁰ EA



67: LH side, includes knobs
C7ZZ-19C696-A

List
\$192.⁵⁰ EA

WE PROUDLY FEATURE AUTHENTIC MUSTANG REPRODUCTIONS FROM SCOTT DRAKE!



Heating & A/C

AC VENT (CONTINUED)



68: LH side, includes knobs
C8ZZ-19C696-A

List
\$192. ⁵⁰ EA

AIR CONDITIONING VENT HOSES



Made by Scott Drake, this set includes original-style moulded cam-locks.

Year	Description	Part No.	List
67-68	Non-insulated	C7ZZ-18S56-A/C	\$26. ⁹⁵ PR

AC VENT DUCT HOSE ADAPTERS



Year	Part No.	List
67-68	C7ZZ-19C692	\$32. ⁹⁵ PR

COIN TRAY



Exact reproduction with polished aluminum trim and textured vinyl insert.

Year	Part No.	List
64-65	C5ZZ-19869	\$54. ⁹⁵ EA

DASH SPACER BAR



Fills gap between dash and A/C unit. Painted black. Helps hold interior air conditioning unit to dash.

Year	Part No.	List
64-65	C5ZZ-19C604	\$39. ⁹⁵ EA
66	C6ZZ-19C604	\$36. ⁹⁵ EA

AIR CONDITIONER REGISTER

Our high quality registers feature a great fit to provide an exact replacement for the originals. Injection molded for a precision fit and long life.



64-65: Front, chrome
C3AZ-19A671-A

List
\$6. ⁵⁰ EA



64-65: Side, black
C5ZZ-19A671

List
\$25. ⁹⁵ EA



66: Front, chrome
C6AZ-19A671-A

List
\$6. ⁵⁰ EA



66: Side, black
C6ZZ-19A671

List
\$25. ⁹⁵ EA

AIR CONDITIONER REGISTER CLIP



These clips are needed for correct installation of registers. Sold in a set of 8 for your convenience.

Year	Description	Part No.	List
64-66	Set of 8	C3AZ-19A683-K	\$11. ⁹⁵ KI

AIR VENT ASSEMBLY



Complete air vent including the cable, knob, and bracket. Very well built.

Year	Description	Part No.	List
65-66		C5ZZ-6501934-A	\$124. ⁹⁵ EA
67-68		C7ZZ-6501934-A	\$124. ⁹⁵ EA
69-70	LH	C9ZZ-6501934-L	\$119. ⁹⁵ EA
69-70	RH	C9ZZ-6501934-R	\$119. ⁹⁵ EA

LEFT HAND AIR VENT INLET GASKET



This is the seal for the air vent housing on the drivers (left hand) side, under the dash on Mustangs from 1964 through 1968.

Year	Part No.	List
64-68	C20Z-6501999	\$1. ⁵⁰ EA

VACUUM CANISTER



Mounts to passenger fender well. Controls doors inside AC unit, includes built in check valve.

Year	Part No.	List
67-70	C8ZZ-19A566	\$99. ⁹⁵ EA

AIR CONDITIONER VACUUM MOTOR



Works for most applications. Modification to bracket may be required. Replacement style.

Year	Part No.	List
67-73	C7AZ-18A318-AR	\$68. ⁹⁵ EA

AIR CONDITIONER VACUUM SWITCH



Mounts on the main air chamber and opens and closes the air vent. Made of nylon with a steel and brass plunger.

Year	Part No.	List
67-70	C7ZZ-18C311	\$39. ⁹⁵ EA

HEATER AND AIR CONDITIONER VACUUM LINE HOSE KIT

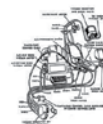

This kit includes color coded rubber hose, 2 plastic "T" connectors and vacuum diagram.

Year	Part No.	List
67-68	C7ZZ-18B372-A	\$14. ⁹⁵ KI

INTERIOR

MUSTANG DASH PADS



MADE FROM ORIGINAL FORD TOOLING

Scott Drake Mustang and Universal Urethane have gone to great lengths to make their dash pads the best on the market. We start by using Ford's Original Tooling. Next we went to Ford's original supplier of vinyl for exact grain and texture. These dash pads are the finest available and easiest to install.



Year	Description	Part No.	List
64-65	Black	C5ZZ-6504290-BK	\$222. ⁹⁵ EA
64-65	Blue	C5ZZ-6504290-BL	\$222. ⁹⁵ EA
64-65	Bright Red	C5ZZ-6504290-BR	\$222. ⁹⁵ EA
64-65	Neutral	C5ZZ-6504290-NL	\$222. ⁹⁵ EA

Year	Description	Part No.	List
66	Black	C6ZZ-6504290-BK	\$222 ⁹⁵ EA
66	Blue	C6ZZ-6504290-BL	\$222 ⁹⁵ EA
66	Bright Red	C6ZZ-6504290-BR	\$222 ⁹⁵ EA
66	Dark Red	C6ZZ-6504290-DR	\$222 ⁹⁵ EA
66	Neutral	C6ZZ-6504290-NL	\$222 ⁹⁵ EA

1967-69

Sorry, Ford's original tooling for 1967-68 Dash Pads was destroyed, see our reproduction pads listed below.

Year	Description	Part No.	List
69-70	Black, w/o AC	C9ZZ-6504282AIA	\$399 ⁹⁵ EA
69-70	Black, w/AC	C9ZZ-6504282BIA	\$399 ⁹⁵ EA
69-70	Neutral, w/o AC	C9ZZ-6504282WNA	\$399 ⁹⁵ EA
69-70	Neutral, w AC	C9ZZ-6504282WAC	\$399 ⁹⁵ EA

Year	Description	Part No.	List
71-73	Black	D1ZZ-6504290-BK	\$249 ⁹⁵ EA
71-73	Blue	D1ZZ-6504290-BL	\$249 ⁹⁵ EA
71-73	Ginger	D1ZZ-6504290-GI	\$249 ⁹⁵ EA



REPRODUCTION DASH PADS

Quality reproduction dash pads, made in the USA and available at a lower price. (Not made from original Ford tooling).

Year	Description	Part No.	List
64-65	Black	C5ZZ-6504290BKR	\$154 ⁹⁵ EA
64-65	Blue	C5ZZ-6504290BLR	\$154 ⁹⁵ EA
64-65	Red	C5ZZ-6504290BRR	\$154 ⁹⁵ EA

Year	Description	Part No.	List
66	Black	C6ZZ-6504290BKR	\$154 ⁹⁵ EA
66	Blue	C6ZZ-6504290BLR	\$154 ⁹⁵ EA
66	Dark Red	C6ZZ-6504290DRR	\$154 ⁹⁵ EA

Year	Description	Part No.	List
67-68	Black	C7ZZ-6504290-BK	\$189 ⁹⁵ EA
67-68	Aqua	C7ZZ-6504290-AQ	\$189 ⁹⁵ EA
67-68	Blue	C7ZZ-6504290-BL	\$189 ⁹⁵ EA
67-68	Ivy Gold	C7ZZ-6504290-IG	\$189 ⁹⁵ EA
67-68	Dark Red	C7ZZ-6504290-RD	\$189 ⁹⁵ EA

1969-70

Sorry, not available.

Year	Description	Part No.	List
71-73	Black	D1ZZ-6504290BKR	\$154 ⁹⁵ EA
71-73	Blue	D1ZZ-6504290BLR	\$154 ⁹⁵ EA
71-73	Ginger	D1ZZ-6504290GIR	\$154 ⁹⁵ EA

PLASTIC DASH COVERS



Molded plastic dash covers that appear to be an original padded dash. Slips over the original padded dash panel for a nifty cure for splits and tears. Completely blocks UV light and the drying effects it causes on vinyl covering on padded dashes.

Year	Description	Part No.	List
64-65		C5ZZ-6504290-DC	\$104 ⁹⁵ EA
66		C6ZZ-6504290-DC	\$104 ⁹⁵ EA
67-68		C7ZZ-6504290-DC	\$110 ⁹⁵ EA
69-70	W/out AC	C9ZZ-6504290-DC	\$114 ⁹⁵ EA
69-70	W/ AC	C9ZZ-6504290DCA	\$114 ⁹⁵ EA
71-73		D1ZZ-6504290-DC	\$104 ⁹⁵ EA

DASH MOLDING CLIP KIT



Dash Molding Clip Kit includes chrome screws and the special spring clips that secure the trim moldings to the dash. 10 pieces. C4DZ-6404561-F fits 1964-65 Falcon/Ranchero.

Year	Part No.	List
64-65	C4DZ-6404561-K	\$5 ⁹⁵ KI

LOWER INSTRUMENT PANEL PAD



Molded in urethane and made with exact detail of the original. Available in assorted colors.

Year	Description	Part No.	List
67-68	Black	C7ZZ-6504292-BK	\$39 ⁹⁵ EA
67-68	Blue	C7ZZ-6504292-BL	\$39 ⁹⁵ EA
67-68	Ivy Gold	C7ZZ-6504292-IG	\$39 ⁹⁵ EA
67-68	Parchment	C7ZZ-6504292-PR	\$39 ⁹⁵ EA
67-68	Dark Red	C7ZZ-6504292-RD	\$39 ⁹⁵ EA
67-68	Aqua/turquoise	C7ZZ-6504292-TQ	\$39 ⁹⁵ EA

DASH PANEL ASSEMBLY

Complete metal stamped dash assembly. 64-65 version will work on 66 with minor modifications.



Year	Part No.	List
64-65	C5ZZ-6504320-A	\$359 ⁹⁵ EA
67-68	C7ZZ-6504320-A	\$359 ⁹⁵ EA
69 w/AC	C9ZZ-6504320-AC	\$419 ⁹⁵ EA

DASH PANEL REPAIR PLATE



For that hacked radio installation, this panel provides a new dashboard section for installation of a stock radio and an original look. Can be welded into position. Designed to fit under dash pad.

Year	Part No.	List
64-66	C5ZZ-6504360-PP	\$29 ⁹⁵ EA

BEZELS. SPACERS & CIGARETTE LIGHTERS

DASH ASH TRAY



This is an exact copy to the original, not the hand fabricated part assembled with generic pop rivets that is also available. Best Quality at the Best Price. Painted Black with correct zinc plated housing. Note: console and quarter panel ash trays can be found in the "Console" and "Quarter Panel" sections of this category.

Year	Part No.	Description	List
64-66	C5ZZ-6204810-A		\$44 ⁹⁵ EA
67	C7ZZ-6204810-A	Will not fit 68	\$29 ⁹⁵ EA

DASH BEZEL AND KNOB KIT

Our six piece kit includes ignition bezel, light switch knob and bezel, wiper knob and bezel, and a cigarette lighter element and knob assembly. *Deluxe kit includes head lamp and wiper retaining nuts.



65-66: Deluxe w/ retaining nuts
C5ZZ-10852-DLXK

List
\$69⁹⁵ KT



65-66
C5ZZ-10852-K

List
\$45⁹⁵ KI



67-68
C7ZZ-10852-K

List
\$61⁹⁵ KI



69
C9ZZ-10852-DLXK

List
\$124⁹⁵ KI

WE PROUDLY FEATURE AUTHENTIC MUSTANG REPRODUCTIONS FROM SCOTT DRAKE!



CIGARETTE LIGHTER SOCKET AND RETAINER



Made by the original supplier. Fits our cigarette lighters.

Year	Part No.	List
64-70	C4AZ-15055-B	\$4.95 ^{EA}

CIGARETTE LIGHTER



These are the best on the market and we invite comparison with any other lighter assembly available. Includes die-cast chromed knob and lighter element with shell. Exactly like the originals.

Year	Part No.	List
64-66	C5ZZ-15052-K	\$13.95 ^{EA}
67-70	C7AZ-15052-K	\$13.95 ^{EA}

CIGARETTE LIGHTER BEZEL AND ELEMENT

Excellent detailing and chrome plating. Like originals.



C4DZ-15054-A
64-66

List
\$8.95^{EA}



D0ZZ-10852-L
70

List
\$17.95^{EA}

CIGARETTE LIGHTER KNOB



Excellent detailing and chrome plating. Like originals.

Year	Part No.	List
64-66	C5ZZ-15052-A	\$7.95 ^{EA}
70	D0ZZ-15052	\$19.95 ^{EA}

WIPER KNOB



Excellent reproductions. Chrome plating, look like originals.

Year	Part No.	List
64-66	C4AZ-17513-A	\$7.50 ^{EA}
69-70	C9ZZ-17513	\$15.95 ^{EA}

WIPER SWITCH BEZEL



A beautiful chrome and black reproduction of the original..

Year	Part No.	List
64-66	C4DZ-10852-A	\$8.25 ^{EA}
69	C9ZZ-10852-W	\$15.95 ^{EA}

WINDSHIELD WIPER SWITCH RETAINING NUT



This beautifully chromed nut holds the wiper switch into the dash. This nut is almost always damaged

from improper tools used for removal and installation. Made from original factory prints.

Year	Part No.	List
65-66	C4DZ-17512-A	\$13.95 ^{EA}

WIPER SWITCH SPACER



Used to install wiper switch to dash. Once a hard part to find now available for trouble free installations. Plated.

Year	Part No.	List
64-66	C4DZ-17C443-A	\$6.00 ^{EA}

WIPER BEZEL STEM NUT TOOL



Special tool designed to insert into wiper bezel stem nut used for assembly or disassembly. Will not damage nut.

Year	Part No.	List
64-66	T-110-RD	\$17.95 ^{EA}

LIGHT SWITCH BEZEL



New, chrome bezels really make a freshly painted dash pop. Beautiful reproductions.

Year	Part No.	List
64-66	C4DZ-10852-B	\$8.25 ^{EA}
67-68	C7ZZ-10852-A	\$9.95 ^{EA}
69-70	C9ZZ-10852-L	\$18.95 ^{EA}

HEADLIGHT SWITCH RETAINING NUT



Beautiful chrome retaining nut that holds headlight switch into the dash. These were previously difficult to find. Made from original factory prints.

Year	Part No.	List
65-66	C5ZZ-11650-A	\$14.95 ^{EA}
67-68	C7ZZ-11650-A	\$14.95 ^{EA}

HEADLIGHT SWITCH COVER



Molded rubber cover which fits over headlamp dimmer switch.

Year	Part No.	List
65-73	C5ZZ-13533	\$4.95 ^{EA}

HEADLIGHT SWITCH KNOB



Knob is die-cast zinc, chrome plated with very good detail. Switch shaft is zinc plated to prevent rust or corrosion.

Year	Part No.	List
64	C4ZZ-11661-A	\$10.95 ^{EA}
65-66	C5ZZ-11661-B	\$9.95 ^{EA}
67-68	C7ZZ-11661-A	\$12.95 ^{EA}
69-70	C9ZZ-11661-A	\$19.95 ^{EA}

IGNITION SWITCH BEZEL



High Quality Chrome. Don't forget to check out our bezel tool made specifically for this bezel to prevent damage.

Year	Description	Part No.	List
64-66		C3AZ-11584-A	\$9.95 ^{EA}
67-68		C60Z-11584-A	\$11.95 ^{EA}
69		C9AZ-11584-A	\$19.95 ^{EA}
69	Spacer	C9ZZ-11574	\$19.95 ^{EA}

IGNITION BEZEL TOOL



Don't scratch that new bezel or freshly painted dash with a screw driver. A dedicated tool made by Scott Drake.

Year	Part No.	List
67-68	T-100-YL	\$17.95 ^{EA}
69	T-109-CL	\$17.95 ^{EA}

IGNITION SWITCH RETAINER

A "must have" part when installing an ignition switch. Zinc plated for years of service.



64-66
C4DZ-10A885-A

List

\$6.00^{EA}



67-68
C7ZZ-11A590-B

List

\$8.95^{EA}

RADIO KNOB AND DIAL SET



Pressure die cast construction. Not cheap light weight plastic. Chrome plated and concurs correct.

Year	Part No.	List
64-66	C4AZ-18817/30-A	\$19.95 ^{SE}
67	C7GY-18817-K	\$48.95 ^{SE}
69-70	C9Z-18817-K	\$45.95 ^{SE}

CONTROL PANEL BEZELS AND LENSES



Made by Drake! These bezel & lenses are an excellent reproduction of a rare option. Fits both dash and console versions. Ford originally used both "seat" and "belt". We chose to reproduce "seat."

Year	Part No.	List
67-68	C7ZZ-10C876-KIT	\$34.95 ^{SE}

1964-66 CONVERTIBLE TOP SWITCH



New and Improved by Scott Drake. This 1964-66 Mustang Convertible Top Switch is made from all new tooling, featuring correct length shaft, correct color coded wires properly riveted to the switch. Perfect fit for Knob and Bezel part # C4DZ-10852-K (sold separately). Note: This is also correct for tailgate window on Falcons.

Year	Description	Part No.	List
64-66	Improved tooling	C4DZ-15668-A	\$44.95 ^{EA}



67: Includes bezel and knob
C7ZZ-15668-A

List

\$54.95^{EA}



69-70
C9Z-15668

List

\$55.95^{EA}



71-73
D1ZZ-15668

List

\$55.95^{EA}

BEZEL INSTALLATION TOOL



This dedicated tool is perfect for installing or removing the chrome bezel on our 1967 Mustang Convertible Top Switch, or the bezel on our 2010 Mustang Billet Antenna.

Year	Description	Part No.	List
67	1967 CV Top Switch Bezel & 2010 Antenna Bezel	T-67-BK	\$18.95 ^{EA}

CONVERTIBLE TOP SWITCH BEZEL & KNOB



Quality chrome plated with black painted "UP" and "DN" markings

Year	Part No.	List
64-66	C4DZ-10852-K	\$36.95 ^{SE}

FOG LIGHT SWITCH KNOB AND BEZEL



Nice touches for corroded or missing original parts. See either "Grille" or "Electrical" section for Fog Light Switches.

Year	Part No.	List
65-67	C5ZZ-15259-AK	\$14.95 ^{EA}

EMERGENCY FLASHER KNOB



Machined brass, exact shape and threads as originals. Beautiful chrome plating.

Year	Description	Part No.	List
67	Non-tilt	C7OZ-17513-A	\$9.95 ^{EA}
67	Tilt	C7OZ-17513-B	\$10.95 ^{EA}
68-69	Tilt	C8MY-17513-C	\$12.95 ^{EA}

EMERGENCY FLASHER BEZEL



This commonly broken piece is now made by Scott Drake! Using ABS construction this part is made from Ford's original print for exact detail.

For fixed columns only.

Year	Part No.	List
67	C7OZ-15C580-A	\$11.95 ^{EA}

TURN SIGNAL LIGHT LEVER



Perfect copies to replace those rusted or tweaked originals. Swaged like originals, not machined like competitors

Year	Description	Part No.	List
64-66	Chrome	C5ZZ-13305-A	\$7.95 ^{EA}
64-66	Satin	C5ZZ-13305-S	\$8.95 ^{EA}
67-73	Chrome	C7ZZ-13305-A	\$7.95 ^{EA}
67-73	Satin	C7ZZ-13305-S	\$8.95 ^{EA}

TURN SIGNAL LIGHT LEVER - SHORT



Same quality as our standard length Turn Signal Light Levers, but in a 1/2" length. Perfect for smaller diameter steering wheels.

Year	Part No.	List
64-66	S1MS-13305-A	\$10.95 ^{EA}
67-73	S7MS-13305-A	\$10.95 ^{EA}

STEERING

CORSO FEROCCE SHELBY STEERING WHEEL



This new Corso Ferocce steering wheel is a stunning replica of the wood rimmed steering wheel originally equipped on the 1967 Shelby GT350 and GT500s. It features a beautifully finished real solid wood with proper finger indents on the back and a black band around the bottom surface just like the originals. The sporty 3 spoke design is brushed stainless steel with 4 chamfered holes per spoke and unique black rubber finger guards. The main center hub is CNC machined aluminum with a satin finish. Concurs correct GT350 and GT500 horn button assemblies are available. We also have a Mustang Horn Button option as well. Each wheel comes equipped with a 65-67 mounting hub. 68-73 Adapter Kit coming soon.

Year	Description	Part No.	List
65-67	Shelby	S7MS-3600-A	\$349.95 ^{EA}

WE PROUDLY FEATURE AUTHENTIC MUSTANG REPRODUCTIONS FROM SCOTT DRAKE!



**CORSO FEROCCE STEERING WHEEL
9 HOLE**



This beautiful Corso Feroce Steering Wheel was handcrafted with pride. Featuring polished aluminum spokes. This black leather wheel has been hand stitched onto a fully padded rim for a truly luxurious feeling. Column Adapter, Mustang or Cobra Emblem are sold separately.

Year	Description	Part No.	List
65-73	Leather, 15" 9 Hole	S1MS-3600-BK	\$149. ⁹⁵ EA



Scott Drake's beautiful Corso Feroce Steering Wheels are the perfect choice for that Classic Cobra, Mustang, or Shelby look. Featuring polished aluminum spokes and made from hand rubbed marine mahogany. Includes stainless steel mounting screws and polished retaining ring for installation. Column Adapter, Horn Button and Mustang or Cobra Emblems are sold separately.

Year	Description	Part No.	List
65-73	Genuine wood, 14" 9 Hole	S1MS-3600-WG-14	\$149. ⁹⁵ EA
65-73	Genuine wood, 15" 9 Hole	S1MS-3600-WG	\$209. ⁹⁵ EA

**CORSO FEROCCE STEERING WHEEL
6 HOLE**



This black leather steering wheel by Corso Feroce closely resembles an original 1965 GT350 Steering Wheel. The Corso Feroce wheel features a functional horn button unlike the original. Column Adapter, Horn Button and Emblems sold separately.

Year	Description	Part No.	List
65-73	Black leather, 15" 6 Hole	S1MS-3600-BK-6	\$159. ⁹⁵ EA

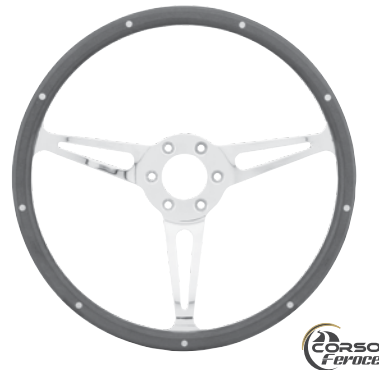

Scott Drakes, beautiful Corso Feroce Steering Wheels are the perfect choice for that clean factory look as seen on original 1965 GT350 Shelby's. Although ours closely resembles the original, we made one big improvement in the fact that ours accepts our functional Horn Button (sold separately). This wheel also features polished aluminum spokes and made from hand rubbed marine mahogany, these 15" diameter wood wheels are handcrafted with pride. Column Adapter, Horn Button and Mustang or Cobra Emblems are sold separately.

Year	Description	Part No.	List
65-73	Genuine wood, 14" 6 Hole	S1MS-3600-WG146	\$219. ⁹⁵ EA
65-73	Genuine wood, 15" 6 Hole	S1MS-3600-WG-6	\$219. ⁹⁵ EA

**CORSO FEROCCE COLUMN ADAPTER
9 HOLE**



Hub to adapt the Corso Feroce steering wheels. Now with adjustable collar. Required to mount Corso Feroce wheel.

Year	Description	Part No.	List
65-67	Billet, 9 hole	S1MS-3511-P	\$84. ⁹⁵ EA
68-73	Billet, 9 hole	S7MS-3511-P	\$84. ⁹⁵ EA

**CORSO FEROCCE COLUMN ADAPTER
6 HOLE**



Hub to adapt the Corso Feroce steering wheels. Now with adjustable collar. Required to mount Corso Feroce wheel.

Year	Description	Part No.	List
65-67	Billet, 6 hole	S1MS-3511-P-6	\$89. ⁹⁵ EA
68-73	Billet, 6 hole	S8MS-3511-P-6	\$89. ⁹⁵ EA

**CORSO FEROCCE SHELBY GT500
HORN BUTTON**



This concours quality reproduction is made just like the originals on the 1967 Shelby's. Features Stamped Steel Show Quality Chrome plated Bezel

with Vacuum Metalized Acrylic lens with raised Aluminum Emblem. Choose from an authentic GT350 or GT500 versions or our Classic Tri-Bar Running Horse Emblem. Fully functional Horn Button assembly compatible with original Shelby Wheels or our S7MS-3600-A Corso Feroce Wheel.



Year	Description	Part No.	List
65-73	Shelby GT500 horn button	S7MS-3623-GT500	\$199. ⁹⁵ EA
65-73	Shelby GT350 horn button	S7MS-3623-GT350	\$199. ⁹⁵ EA
65-73	Mustang horn button	S7MS-3623-MG	\$149. ⁹⁵ EA

**CORSO FEROCCE HORN BUTTON
9 HOLE**



This horn button assembly features chrome plated plastic injected center cap with clear acrylic domed lens house. 1 of 2 optional emblems. Emblems sold separately.

Year	Description	Part No.	List
65-73	9 Hole	S1MS-3623-A	\$15. ⁹⁵ EA

CORSO FEROCCE HORN BUTTON

6 HOLE



This horn button assembly features chrome plated plastic injected center cap with clear acrylic domed lens. Houses 1 of 2 optional emblems. Emblems sold separately.



Year	Description	Part No.	List
65-73	6 Hole	S1MS-3623-A-6	\$21.95 EA

COBRA HORN BUTTON EMBLEM

6 HOLE



This horn button assembly features chrome plated plastic injected center cap with clear acrylic domed

lens made especially for our 6 hole Corso Feroce steering wheel. The center houses our beautifully detailed Cobra emblem.



Year	Description	Part No.	List
65-73	6 Hole	S1MS-3623-COBRA	\$39.95 EA

HORN BUTTON EMBLEMS

This fits the horn button to change center emblem to Cobra or Mustang. Fits both 6 and 9 hole wheels. See Key Fobs in "Accessories" section for other available emblems.



65-73: Cobra
S1MS-3649-C



List
\$13.95 EA



65-73: Mustang, plastic injection, back painted 3D emblem
C7ZZ-65044A90-M



List
\$19.95 EA

MUSTANG HORN RING BUTTON



Excellent concours reproduction made by Scott Drake. Diecast construction features acrylic plastic center emblem, chrome plated main assembly and painted recesses. 1964-66 fully assembled and ready to install. Horn Spring not included.

Year	Part No.	List
65-66	CSZZ-13A805-B	\$104.95 EA
64	CSZZ-13A805-C	\$104.95 EA

HORN RING BUTTON



65-67: Deluxe, for wood wheel, no emblem, 3 spoke
C70Z-13A805-ER

List
\$56.95 EA



67: Standard, no emblem, 3 spoke
C7ZZ-13A805-A

List
\$89.95 EA



68-69: Standard, no emblem, 2 spoke Satin
C9AZ-13A805-B

List
\$64.95 EA

DELUXE STEERING WHEEL ASSEMBLY



Reproduction of Pony interior simulated wood wheel. Includes horn ring, contact plates and hardware. This wheel was also optional on

standard interior cars. Horn center cap sold separately. We also offer the wheel separately for those who wish to re-use their horn ring, etc...

Year	Description	Part No.	List
65-66	Woodgrain, Assembly	CSZZ-3600-NK*	\$374.95 SET
65-66	Woodgrain, wheel only	CSZZ-3600-N	\$219.95 EA
67	Woodgrain, Assembly	C70Z-3600-NK	\$379.95 SET

* Also correct for 1966 Shelby



A beautiful reproduction of the original 1969 Mustang Deluxe Rim Blow Steering Wheel that was standard on the Mach 1,

Deluxe Interior, and Grande Mustangs is now available from Scott Drake. It features a black base with simulated Walnut Wood Grain Rim. Horn Pad Assembly and Rim Blow Switch sold separately..

Year	Description	Part No.	List
69	Woodgrain, Rim blow steering wheel	C9AZ-3600-BK	\$659.95 EA

DELUXE STEERING WHEEL UPPER COLLAR



Year	Description	Part No.	List
67	Deluxe	C70Z-3656-A	\$39.95 EA

DELUXE STEERING WHEEL COLLAR



Mounts on bottom of original deluxe wheel. Die cast construction like original. Concours plating.

Year	Part No.	List
65-66	CSZZ-3491-A	\$45.95 EA
67	C70Z-3491-A	\$64.95 EA

DELUXE 3-SPOKE STEERING WHEEL EMBLEM



Features ABS injection with a crystal clear lense, and a highly detailed Mustang logo. This is the center emblem for 3-spoke style.



Year	Description	Part No.	List
69	For 1969 3-spoke style steering wheel	C9ZZ-3649-B	\$21.95 EA
70-73	Deluxe emblem	D0ZZ-3649	\$23.95 EA

STEERING WHEEL CENTER

Deluxe wheel only. Pressure die cast with quality chrome plating. Includes lens, rim, spring steel snap ring.

65-66: Concours, Made in the USA
CSZZ-3623-A



List
\$99.95 EA



65-66: Economy, Import
CSZZ-3623-AR

List
\$58.95 EA



66: Shelby, Made in the USA
S2MS-3623-A



List
\$99.95 EA

WE PROUDLY FEATURE AUTHENTIC MUSTANG REPRODUCTIONS FROM SCOTT DRAKE!



STEERING WHEEL EMBLEM

The most authentic and best looking emblems available.



67: Running horse
C7ZZ-3649-A



List

\$24.95 EA



68: Running horse
C8ZZ-3649-AR



List

\$29.95 EA



69-70: Shelby Cobra
C9MS-3649-A



List

\$22.95 EA



69-73: For use on
2-spoke wheel
C9ZZ-3649-S



List

\$18.95 EA

STEERING WHEEL HUB AND EMBLEM TRIM



Great kit for complete steering wheel restoration.



Year	Part No.	List
67	C7ZZ-3649/56-K	\$32.95 KI

STANDARD MUSTANG STEERING WHEELS

A new steering wheel can bring your entire interior together. Replace your cracked and faded originals



Year	Description	Part No.	List
64	Black, generator	C4ZZ-3600-BK	\$174.95 EA
64	Blue, generator	C4ZZ-3600-BL	\$174.95 EA
64	Red, generator	C4ZZ-3600-RD	\$174.95 EA
64	White, generator	C4ZZ-3600-WT	\$174.95 EA
65-66	Black	C5ZZ-3600-BK	\$164.95 EA
65	Blue	C5ZZ-3600-BL	\$164.95 EA
65	Bright red	C5ZZ-3600-BR	\$164.95 EA
65	Palamino	C5ZZ-3600-PA	\$164.95 EA
65-66	White	C5ZZ-3600-WT	\$164.95 EA
66	Aqua	C6ZZ-3600-AQ	\$164.95 EA
66	Dark red	C6ZZ-3600-DR	\$164.95 EA
66	Light blue	C6ZZ-3600-LB	\$164.95 EA

Year	Description	Part No.	List
66	Parchment	C6ZZ-3600-PR	\$164.95 EA
67	Black	C7ZZ-3600-BK	\$174.95 EA
67	Blue	C7ZZ-3600-BL	\$174.95 EA
67	Dark red	C7ZZ-3600-DR	\$174.95 EA
67	Ivy Gold	C7ZZ-3600-IG	\$174.95 EA
67	Light Parchment	C7ZZ-3600-PR	\$174.95 EA
68-69	Black 2 spoke	C8ZZ-3600-BK	\$199.95 EA

HORN RING CENTER PAD



Soft padded urethane. Not painted but molded urethane so color will not wear off. Features our chrome trim ring and center emblem.



Year	Description	Part No.	List
67	Black	C7ZZ-3623-BK	\$84.95 EA
67	Aqua	C7ZZ-3623-AQ	\$84.95 EA
67	Blue	C7ZZ-3623-BL	\$84.95 EA
67	Ivy Gold	C7ZZ-3623-IG	\$84.95 EA
67	Parchment	C7ZZ-3623-PR	\$84.95 EA
67	Red	C7ZZ-3623-RD	\$84.95 EA
67	Saddle	C7ZZ-3623-SA	\$84.95 EA

STEERING WHEEL HUB TRIM



This is the chrome trim ring that goes on the steering wheel hub. 4 3/8" diameter. Installation note: warm up foam hub

with hot air, apply solution of dish washing soap & water, then press firmly. Start at one end pressing firmly while rotating (like a bicycle tire).

Year	Part No.	List
67	C7ZZ-3656-A	\$11.95 EA

HORN PANEL BEZEL KIT



Everything you need including the plastic injection and chrome plated bezel; horn panel pad; Mustang tri-bar

logo horn button; and horn panel bezel buttons.



Year	Part No.	List
68	C8ZZ-3D572-KIT	\$104.95 EA

HORN PANEL BEZEL



Plastic injection and chrome plated. Fits in center of steering wheel, holds vinyl pad and buttons.

Year	Part No.	List
68	C8ZZ-3D572-AR	\$21.95 EA

HORN PANEL BEZEL BUTTONS

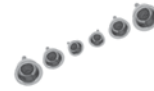

Chromed Plastic buttons with textured black centers. Set of 6. Standard interior only.

Year	Description	Part No.	List
68	Set of 6	C8ZZ-3600-AR	\$28.95 SE

HORN PANEL PAD



Year	Description	Part No.	List
68	Black, standard interior	C8AZ-3629-BK	\$21.95 EA
68	Parchment, standard interior	C8AZ-3629-N	\$21.95 EA



Year	Description	Part No.	List
69	Black deluxe 3 spoke	C9ZZ-3623	\$84.95 EA
70-73	Black deluxe 3 spoke	D0ZZ-3623-A	\$149.95 EA



Year	Description	Part No.	List
70-73	Black standard	D0ZZ-13915	\$84.95 EA

RIM BLOW HORN PAD COVER



Complete assembly (21 pcs) that installs over the top of the horn pad. Emblem sold separately.

Year	Part No.	List
69	C9ZZ-3752	\$119.95 EA

HORN BUTTON RUBBER SPRING PAD



This is the OE rubber pad that is typically smashed in the horn button.

Year	Part No.	List
64-67	C0DZ-13A813-A	\$2.95 EA

RIM BLOW HORN SWITCH



The switch that goes inside the rim of the steering wheel to actuate the horn.

Year	Description	Part No.	List
69	Switch	C9AZ-13A875-C	\$134.95 EA
70-73	Switch	D1AZ-13A875-A	\$119.95 EA

GRANT STEERING WHEEL



Aluminum frame aftermarket steering wheel with Mustang center emblem on horn center. Choose from real wood or black foam. Adapter required.

Year	Description	Part No.	List
64-73	Wood, 15"	966	\$184.95 EA
65-73	Black foam, 15"	968	\$134.95 EA
65-73	Wood, 13-1/2"	963	\$179.95 EA



Signature series also available. Features include: genuine mahogany grips, polished aluminum spokes, machined billet trim rings,

horn button and hub cover. Requires either hub or adapter kit for installation.

Year	Description	Part No.	List
65-73	Grant signature series, 15"	1170	\$249.95 EA
65-73	Grant signature series, 15" With simulated rivets	1175	\$309.95 EA

GRANT STEERING WHEEL ADAPTER



Mounting and contact adapter required for each Grant wheel. **Note: Do**

not use with Flaming River aftermarket columns.

Year	Part No.	List
68-73	3249	\$26.95 EA
64	3285	\$26.95 EA
65-67	3294	\$26.95 EA

GRANT HUB KIT

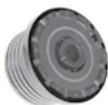

These kits are fully assembled for easy installation and are available in either a highly polished

mirror finish or anodized in deep, black luster finish. Year 1170 and 1175 wheels only.

Part No.	Year	Description	List
5249	68-73	Black	\$71.95 EA
5249-1	68-73	Highly polished, Alum	\$71.95 EA

GRANT HORN BUTTON

Optional button to customize your Grant steering wheel.



64-73: Grant 966, 968 and 963 wheels 5847



List
\$34.95 EA



64-73: Chrome, fits 1170 and 1175 5875



List
\$44.95 EA



65-73: Ford blue, fits 1170 and 1175 5665



List
\$24.95 EA



64-73: Horn button, 0 fits 1170 and 1175 5668



List
\$24.95 EA

FLAMING RIVER RACK & PINION KIT



Manual steering that feels like power steering. Easy installation that maintains the original suspension. No welding. No fabrication.

Due to many variations, we recommend contacting us with your specific application to assure the correct kit. Tilt columns for original steering wheel are available as a special order. Power Steering Kit available as a special order.

Year	Description	Part No.	List
64-69	Rack and pinion, stock spindles, stock exhaust manifolds, no tilt column. Modify factory column.	CSZZ-3304-RPSM	\$1,054.95 KT
64-69	Rack & pinion, Granada spindles, stock exhaust manifolds, w/ paintable tilt column. Aftermarket wheel.	CSZZ-3304-RPK	\$1,399.95 KI
64-70	Small block, w/ headers, no tilt column. Modify factory column.	CSZZ-3304-RPSH	\$1,599.95 EA
64-69	SB, w/ headers, w/ paintable tilt column. Aftermarket wheel.	CSZZ-3304-RPSHK	\$1,775.00 EA

IDIDIT TILT STEERING COLUMN

Ididit introduces the first Ford Top Shaft and Ford Turn Signal Switch tilt steering column for 1965-69 Mustangs! This made to fit column will include a special new floor mount, 8-position tilt, Mustang style knobs & handles and male & female plugs with terminals. ididit's new Mustang column will accept a stock Mustang steering wheel or an aftermarket wheel with an adaptor. By using the stock underdash mount and a coupler (sold separately), the installation is a breeze! The new 8-position tilt 1965-69 Mustang column is available in Paintable Steel, Chrome and Black Powder Coated. Lower shaft is 3/4" 36. Don't forget your installation kit, each installation kit from ididit is specific to your Mustang application. Each ididit column is 100% American Made. Note: 65-67E require cutting original shaft. The below part numbers are for use with stock steering boxes. For Rack and Pinion add "-RP" which are available as a Special Order for \$25 more.



Year	Description	Part No.	List
65-66	Paintable steel	CSZZ-3514-S	\$549.95 EA
65-66	Black	CSZZ-3514-B	\$699.95 EA
65-66	Chrome	CSZZ-3514-C	\$624.95 EA
67	Paintable steel	C7ZZ-3514-S	\$499.95 EA
67	Black	C7ZZ-3514-B	\$599.95 EA
67	Chrome	C7ZZ-3514-C	\$649.95 EA
68-69	Paintable steel	C8ZZ-3514-S	\$609.95 EA
68-69	Black	C8ZZ-3514-B	\$749.95 EA
68-69	Chrome	C8ZZ-3514-C	\$724.95 EA

IDIDIT TILT STEERING COLUMN MOUNT KIT



These kits include the components needed to install your ididit Tilt Steering Column. Use with stock steering boxes only.

Will not fit Rack & Pinion kits.

Year	Part No.	List
65 - early 67	CSZZ-3514-IK	\$59.95 EA
Late 67 - 68	C7ZZ-3514-IK	\$199.95 EA
69	C9ZZ-3514-IK	\$134.95 EA

WE PROUDLY FEATURE AUTHENTIC MUSTANG REPRODUCTIONS FROM SCOTT DRAKE!



FLAMING RIVER TILT STEERING COLUMN



Available in paintable steel or polished stainless steel. Requires mounting kit. Will fit 1970 cars but relocation of ignition switch is required. These fit original steering boxes only. Modifications required to 64-67E shaft. Original versions have original Ford splines to accept factory wheels. The below Tilt Steering Columns are for use with factory steering boxes only and are not to be used with rack & pinion kits. Rack & pinion kits are available as a Special Order, add "-RP" to the end of the appropriate part number below. Prices are the same provided it can be added to our next stocking order, otherwise additional freight charges will apply.

Year	Description	Part No.	List
65-66	For Grant wheels only	C5ZZ-3514-AFT	\$329 ⁹⁵ EA
65-66	For Grant wheel, Stainless	C5ZZ-3514-AFT-S	\$699 ⁹⁵ EA
65-66	For original wheel	C5ZZ-3514-OEM	\$414 ⁹⁵ EA
Late 67-69	For Grant wheels only	C7ZZ-3514-AFT	\$329 ⁹⁵ EA
Late 67-69	For Grant wheel, Stainless	C7ZZ-3514-AFT-S	\$629 ⁹⁵ EA
Late 67-69	For original wheel	C7ZZ-3514-OEM	\$414 ⁹⁵ EA

FLAMING RIVER TILT STEERING COLUMN MOUNT KIT



This kit includes all components to install a Flaming River tilt column.

Year	Part No.	List
65- early 67	C5ZZ-6504459-MK	\$129 ⁹⁵ EA
Late 67-70	C7ZZ-3514-MK	\$129 ⁹⁵ EA

LOWER STEERING COLUMN COVER

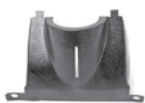

A very nice reproduction of a commonly broken part.

Year	Part No.	List
69	C9ZZ-6504459-BK	\$49 ⁹⁵ EA
70	D0ZZ-6504459-BK	\$49 ⁹⁵ EA
71-73	D1ZZ-6504459	\$32 ⁹⁵ EA

CUSTOM 6 HOLE INSTRUMENT PANEL BEZEL



New by Scott Drake, this 1965-66 Mustang Custom 6 Hole Instrument Bezel is a great way to upgrade your gauge set while retaining the factory appearance. Available with a brushed aluminum insert, metal back walnut insert on aluminum, or black camera case. These high quality bezels are precision crafted to replace your stock unit exactly. Features include: two 3 3/8" holes for a tach and speedometer, four 2 1/16" holes for the gauges of your choice, and integrated turn signal/high beam indicator lens for OEM bulb and connector. Designed to work with most any aftermarket gauges.

Year	Description	Part No.	List
65-66	Brushed Aluminum	C5ZZ-10838-6-AL	\$179 ⁹⁵ EA
65-66	Black Camera Case	C5ZZ-10838-6-BK	\$174 ⁹⁵ EA
65-66	Woodgrain	C5ZZ-10838-6-WG	\$189 ⁹⁵ EA

INSTRUMENT PANEL AND GLOVE BOX



This kit will really make your interior stand out. We have taken our beautiful reproduction 65 GT instrument panel and flat glove box

door and added brushed aluminum inserts. The glove box door comes without the horse emblem for a clean look. This also allows you to add the emblem of your choice. Brushed aluminum panels are also available as a set without the instrument panel or door.

Year	Part No.	List
65-66	KIT-INT-AL	\$179 ⁹⁵ SE

INSTRUMENT PANEL & GLOVE BOX INSERT



These fit our 65 GT instrument panel and our flat glove box door.

Year	Description	Part No.	List
65-66	Aluminum	KIT-INT-ALMI	\$59 ⁹⁵ SE
65-66	Woodgrain	WG-126-V	\$15 ⁹⁵ SE

INSTRUMENT PANEL INSERT



These are metal backed wood grained panels. Under extreme heat these will not peel like competitors. Las Vegas summer tested. See our Glove Box section, later in this category, for matching glove box inserts.

Part No.	Year	Description	List
C5ZZ-10838-WMI	65-66	Woodgrain	\$16 ⁹⁵ PR

DASH PANEL WOODGRAIN INSERTS



Now available exclusively from Scott Drake are the 69, Mach 1, Deluxe and Grande Walnut Woodgrain as Inserts. Never before available due to the

extreme difficulty in manufacturing. These are complete stamped steel panels have woodgrain permanently attached, not a Vinyl overlay that will shrink, crack or peel off. Note some early 69 cars had Teak inserts which is not available. Sold as a pair only for a perfect Match to each other. 1970 version available early 2016.

Year	Description	Part No.	List
69	Walnut	C9ZZ-10838-WMIK	\$334 ⁹⁵ PR

INSTRUMENT BEZEL



Our bezel are the best, they feature details that others simply don't have. Chrome is superior and all fit accurately..

Year	Description	Part No.	List
65-66	Pony, w/ wood-grain insert (metal backed)	C5ZZ-10838-BMI	\$54 ⁹⁵ EA
65-66	Economy - Pony, w/ vinyl wood-grain insert	C5ZZ-10838-B	\$45 ⁹⁵ EA



64-65: Black, camera case finish
C5ZZ-10838-A

List
\$29⁹⁵ EA



65: GT, Black
C5ZZ-10838-C

List
\$44⁹⁵ EA



66: Black
C6ZZ-10838-A

List
\$29⁹⁵ EA



67: Deluxe, brushed aluminum
C7Z-10838-B

List

\$144.⁹⁵ EA



67: Black
C7Z-10838-C

List

\$59.⁹⁵ EA



68: Black, camera case finish
C8Z-10838-A

List

\$64.⁹⁵ EA



68: Deluxe, w/ woodgrain insert (economy)
C8Z-10838-B

List

\$99.⁹⁵ EA



68: Deluxe, w/ woodgrain insert (metal backed)
C8Z-10838-BMI

List

\$144.⁹⁵ EA



69: Black, camera case finish, Standard Interior
C9Z-10838-A

List

\$129.⁹⁵ EA



69: Mach/Deluxe Interior
C9Z-10838-C

List

\$149.⁹⁵ EA



70: Black, camera case finish
D0Z-10838-A

List

\$129.⁹⁵ EA



71-73: Black
D1Z-10838-A

List

\$109.⁹⁵ EA

INSTRUMENT BEZEL MOUNTING SET



These are the screws that attach the instrument cluster bezel to the dash.

Year	Part No.	List
64-66	CSZ-10848-MK	\$2. ⁵⁰ KI

INSTRUMENT BEZEL RETAINING CLIPS



Very hard to find, unique top retaining clips for 64-66 Mustang instrument bezels. Top 4 are very special clips, commonly missing. Set of 6.

Year	Part No.	List
64-66	379130-S	\$4. ⁹⁵ SE

INSTRUMENT LENS ANTI-RATTLE PAD



This simple little kit takes care of those rattles between the instrument lens and the bezel. Insert in front of instrument lenses.

Year	Description	Part No.	List
64-65	10 piece set	C4DZ-10856	\$3. ⁹⁵ SE
66	13 piece set	C6DZ-10856	\$4. ⁹⁵ SE

INSTRUMENT LENS RETAINER BEZEL



These painted black bezels retain the lenses to the instrument bezel. Works on tach and non-tach vehicles, and cars with optional clock.

Year	Part No.	List
67-68	C7Z-10890-LRK	\$32. ⁹⁵ SE

INSTRUMENT LENS



Optical grade injection molded plastic.

Year	Description	Part No.	List
64	Generator style	C4DZ-10887-A	\$19. ⁹⁵ EA
65	Alternator style	CSZZ-10887-A	\$19. ⁹⁵ EA



Optical grade injection molded plastic.

Year	Description	Part No.	List
65-66	Full Instrumentation	CSZZ-10887-B	\$9. ⁹⁵ EA

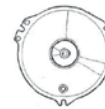

Optical grade injection molded plastic.

Year	Description	Part No.	List
67-68:	Speedometer, oil, alternator, tach	C7Z-10887-A	\$10. ⁰⁰ EA
67-68	Speedometer, w/ trip odometer	C7Z-10887-B	\$19. ⁹⁵ EA
67-68	Fuel, temperature	C7Z-10887-C	\$6. ⁰⁰ EA
67-68	Center, w/ hole for clock option	C7Z-10887-D	\$6. ⁰⁰ EA



67-68: 5 piece set
C7Z-10887-A/C

List

\$32.⁹⁵ SE



67-68: 5 piece set, w/ tachometer
C7Z-10887-A/D

List

\$39.⁹⁵ SE



69-70: Set, w/o tachometer
C9Z-10887-A

List

\$38.⁹⁵ SE



69-70: Set, w/ tachometer
C9Z-10887-T

List

\$49.⁹⁵ SE



71-73: w/out tachometer
D1Z-10887-AR

List

\$64.⁹⁵ EA

CLOCK LENS



Deluxe clock lens with pointer.

Year	Description	Part No.	List
69-70	Deluxe, w/ pointer	C9Z-15000	\$64. ⁹⁵ EA

TRIP RESET BUTTON ASSEMBLY



A wonderful reproduction of a very hard to find part. Designed for easy installation and adjustment.

Year	Part No.	List
67-68	C7Z-17A381-B	\$19. ⁹⁵ SE

WE PROUDLY FEATURE AUTHENTIC MUSTANG REPRODUCTIONS FROM SCOTT DRAKE!



INSTRUMENT PANEL LIGHT FILTERS

(SET OF 4, WITH SCREWS)



Add new brightness to your instrument gauge panel. They look great on stock panels or with our white-face panel inserts. 4 Filter set with mounting screws.

Year	Description	Part No.	List
64-66	Blue - original	C4VY-10B870-B-4	\$9 ⁹⁵ SE
64-66	Red	C4VY-10B870-R-4	\$11 ⁹⁵ SE
64-66	Amber/yellow	C4VY-10B870-Y-4	\$11 ⁹⁵ SE

INSTRUMENT PANEL LIGHT FILTER

(SET OF 8)



Add new brightness to your instrument gauge panel. They look great on stock panels or with our white-face panel inserts. Set of 8. Re-use existing screws.

Year	Description	Part No.	List
67-70	Blue - original	C4VY-10B870-B-8	\$15 ⁹⁵ SE
67-70	Red	C4VY-10B870-R-8	\$17 ⁹⁵ SE
67-70	Amber/yellow	C4VY-10B870-Y-8	\$17 ⁹⁵ SE

INSTRUMENT PANEL LED LIGHTS

Finally see your gauges at night with cool-running, lifetime LED's. 4x brighter than old incandescent lights! Each kit is warranted for the life of your car, and includes gauge illumination lights (blue), turn signal indicator lights (white), and high-beam light (white/red). These kits use your existing gauges -- you just replace the bulbs! Lifetime warranty! See "Electrical" section for stock replacement bulbs.



Year	Description	Part No.	List
64-66	Long Speedometer	SD-6456-GA-BL	\$25 ⁹⁵ EA
65-66	5-Gauge Cluster	SD-66-GA-BL	\$30 ⁹⁵ EA
67-68		SD-6768-GA-BL	\$30 ⁹⁵ EA
69-70		SD-6970-GA-BL	\$35 ⁹⁵ EA
71-73		SD-7173-GA-BL	\$35 ⁹⁵ EA
64-68	White 1895, set of 4	SD-1895	\$16 ⁹⁵ SE
64-68	Blue 1895, set of 4	SD-1895-BL	\$16 ⁹⁵ SE

INSTRUMENT CLUSTER BULB SOCKET



This plastic socket is used with #194 bulbs and twists into the backside of the 69-73 Instrument Clusters.

1969-70 use 13 and 71-73 use 4.

Year	Part No.	List
69-73	C80Z-13711-B	\$3 ⁵⁰ EA

ELECTROLUMINESCENT INSTRUMENT PANEL SET

A Scott Drake exclusive. Our panels actually glow! Light intensity can be changed with a dedicated controller. Color can be changed from soft blue to soft green with the push of a button. Instrument bezel and actual gauges are not included.



65: 3 piece
C5ZZ-10890-GLO

List
\$99 ⁹⁵ ST



67-68: 6 piece, 6000 RPM
C7ZZ-17360-GLO6

List
\$99 ⁹⁵ SE



69-70: 6 piece, no tachometer
C9ZZ-10890-GLO

List
\$99 ⁹⁵ ST



71-73: 5 piece
D1ZZ-10890-GLO

List
\$99 ⁹⁵ ST

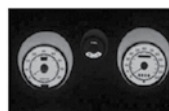

71-73: w/ tachometer
D1ZZ-10890-TGLO

List
\$99 ⁹⁵ ST

WHITE FACE INSTRUMENT PANEL SET

These inexpensive kits are perfect for the resto-mod or anyone looking for a more modern look. These kits are installed onto your original black faced gauges with double sided tape. All numbers, letters and markings are copied exactly as original. Perfectly die cut to ease installation. Instrument bezel and actual gauges are not included.



64-65: 3 piece
C5ZZ-10890-W

List
\$54 ⁹⁵ SE



65-66: 5 piece
C6ZZ-10890-W

List
\$54 ⁹⁵ SE



67-68: 11 piece, w/out tach
C7ZZ-10890-W

List
\$59 ⁹⁵ SE

CLOCK

Brand new as original dash clock, made from all new Scott Drake tooling, correct colors and numbers. Originals rarely work, easily installs into cars that did not have a clock originally. All new and improved tooling.



Year	Description	Part No.	List
67-68	Quartz movement	C7AZ-15000-A	\$99 ⁹⁵ EA

CLOCK KNOB AND SCREW SET



Our Clock adjusting knob features great detail and a nice chrome finish. The set screw is threaded for the original clock stem.

Year	Part No.	List
67-68	C7ZZ-15032-A	\$14 ⁹⁵ EA

INSTRUMENT VOLTAGE REGULATOR



From Scott Drake, these Instrument Voltage Regulators feature an improved design to be more reliable and accurate in varying environments (heat, humidity, etc...). Features solid state electronic circuitry and variable control. Preset to factory specifications but adjustable to fine-tune your gauges. 69-70 will be available late Spring 2012.

Year	Part No.	List
64-66	B9MZ-10804-EADJ	\$39 ⁹⁵ EA
67-68	C6DZ-10804-EADJ	\$39 ⁹⁵ EA
69-73	C9AZ-10804-EADJ	\$39 ⁹⁵ EA

AMPERAGE GAUGE



These high quality gauges are manufactured with UV coating to protect the silk screened printing from fading. Gauges are exact reproductions complete with the Ford part number and logos. All gauges are pre-tested for accuracy. (66 Will not fit 65)



Year	Description	Part No.	List
66		C5ZF-10671	\$59. ⁹⁵ EA
69	Black	C9ZF-10671-A	\$64. ⁹⁵ EA
70	Gray	D0ZF-10671-A	\$74. ⁹⁵ EA

FUEL GAUGE



These high quality gauges are manufactured with UV coating to protect the silk screened printing from fading. Gauges are exact reproductions complete with the Ford part number and logos. All gauges are pre-tested for accuracy.



Year	Description	Part No.	List
64-65	Standard	C5DF-9306	\$59. ⁹⁵ EA
65-66	GT & Pony 66: All	C5ZF-9306	\$59. ⁹⁵ EA
68	Black, w/o tach	C7ZF-9306	\$64. ⁹⁵ EA
69	Black, w/o tach	C9ZF-9280	\$64. ⁹⁵ EA
70	Gray, w/o tach	D0ZF-9280	\$64. ⁹⁵ EA

FUEL-TEMP GAUGE



Exact reproduction of factory gauge.



Year	Description	Part No.	List
69	Black	C9ZF-9A284	\$139. ⁹⁵ EA
70	Gray	D0ZF-9A284	\$139. ⁹⁵ EA

OIL PRESSURE GAUGE



These high quality gauges are manufactured with UV coating to protect the silk screened printing from fading. Gauges are exact reproductions complete with the Ford part number and logos. All gauges are pre-tested for accuracy.



Year	Description	Part No.	List
65-66		C5ZF-9B309	\$59. ⁹⁵ EA
69	Black w/out tach	C9ZF-9B309-A	\$74. ⁹⁵ EA
70	Gray w/out tach	D0ZF-9B309-A	\$74. ⁹⁵ EA

SPEEDOMETER GAUGE



This high quality speedometer gauge is an exact reproduction of the original, complete with correct Ford part number and logo. The silk screened print is UV protected for longer life and fade resistance. All gauges are pre-tested for accuracy.

Year	Description	Part No.	List
64-65	Standard	C5DF-17266	\$79. ⁹⁵ EA
65-66	65: GT 66: All	C5ZF-17265	\$79. ⁹⁵ EA
67-68	All 120 mph	C9ZF-17265	\$139. ⁹⁵ EA
69	Standard, w/o tach	C9ZF-17265	\$139. ⁹⁵ EA
69-70	69: Deluxe and Mach 1, 70: All	D0ZF-17265	\$139. ⁹⁵ EA

TEMPERATURE GAUGE



These high quality gauges are manufactured with UV coating to protect the silk screened printing from fading. Gauges are exact reproductions complete with the Ford part number and logos. All gauges are pre-tested for accuracy.

Year	Description	Part No.	List
64-65	Standard	C5DF-10971	\$59. ⁹⁵ EA
65-66	65: GT 66: All	C5ZF-10971	\$59. ⁹⁵ EA
69	Black, w/o tach	C9ZF-10B966	\$139. ⁹⁵ EA
70	Gray, w/o tach	D0ZF-10B966	\$64. ⁹⁵ EA

KM GAUGE, SPEEDOMETER OVERLAY



Adhesive backed decal to convert MPH to KM.

Year	Description	Part No.	List
64-65	Overlay	C5DZ-10890-KM	\$36. ⁹⁵ EA
66	Overlay 140mph - 230km	C6DZ-17265-KM	\$36. ⁹⁵ EA
66	Overlay 120mph - 200km	C6DZ-17265-KM-6	\$36. ⁹⁵ EA
67-68	Overlay	C7DZ-17265-KM	\$36. ⁹⁵ EA

HOOD TACHOMETER GAUGE

The classic hood mounted tach from the 60's. Black plastic housing with a black dial face and back lit numbers makes this a great add-on accessory. Feature a red-line needle. Holes must be drilled in the hood for proper installation.



65-70: Black face, 8000 RPM
C8AZ-17A326-B

List

\$399.⁹⁵ EA



65-70: White face, 8000 RPM
C8AZ-17A326-W

List

\$399.⁹⁵ EA

RALLY PACS & GAUGE PODS

64-66 RALLY PACS

Scott Drake is proud to announce the arrival of our 1965 Rally Pac! This option is now available to compliment our popular line of 1966 Rally Pacs. Available in all black, or black with chrome hood (pictured to the left). Our Rally Pacs are the only ones that work with most modern ign. systems! With unsurpassed quality, attention to detail & options, Scott Drake Mustang Rally Pacs are the absolute best on the market!

- Features a modern air-core movement tachometer and a quartz movement clock.
- Clock and tachometer faces feature the original style fonts and are back lit for improved visibility at night.
- Housing and bezels are pressure zinc die-cast from our own tooling and coated with a tough crinkle texture.
- Our Rally Pac's include all of the brackets and color coded wire harnesses and easy to follow installation instructions.
- Scott Drake Rally Pacs are the only ones that work with most modern ign. systems!
- Available in the 6 most popular '66 Mustang interior colors, or new Satin chrome.
- Available for 6 or 8 cylinder engine applications.
- They will be available with "Mustang" or "Ford" logos early in 2016 under new part numbers.



Part No.	Year	Description	List
CSZZ-10B960CBKC	64-65	V8, 6000 RPM, black	\$389. ⁹⁵ SE
CSZZ-10B960CBKC	64-65	V8, 6000 RPM, black w/ chrome	\$389. ⁹⁵ SE
CSZZ-10B960KBK	64-65	V8, 8000 RPM, black	\$394. ⁹⁵ SE
CSZZ-10B960KBKC	64-65	V8, 8000 RPM, black w/ chrome	\$399. ⁹⁵ SE

Interior

WE PROUDLY FEATURE AUTHENTIC MUSTANG REPRODUCTIONS FROM SCOTT DRAKE!



129

Authorized Dealer

RALLY PACS WITHOUT IDENTIFIERS



Scott Scott Drake is proud to announce the latest addition to our popular line of 1964-65 Mustang Rally Pacs. This new addition is solid black and features a plain black center emblem with no other identifiers. When Ford first introduced the Rally Pac it did not have the Logo so all 1964's and many early 1965's that rolled off the assembly line with the Rally Pac option did not have a logo on it. Late 1965's and all dealer add-ons and over the counter Rally Pacs had the Logo. Scott Drake Rally Pacs are the only ones that work with most modern ignition systems!

Part No.	Year	Description	List
C5ZZ-10B960C-NL	64-65	V8, 6000 RPM, plain	\$384. ⁹⁵ SE
C5ZZ-10B960K-NL	65	V8, 8000 RPM, plain	\$389. ⁹⁵ SE



1966 V8, 6,000 RPM

Year	Description	Part No.	List
65-66	V8, 6000 RPM, black	C6ZZ-10B960CBK	\$389. ⁹⁵ SE
65-66	V8, 6000 RPM, white	C6ZZ-10B960CWT	\$434. ⁹⁵ SE
66	V8, 6000 RPM, aqua	C6ZZ-10B960CAQ	\$434. ⁹⁵ SE
66	V8, 6000 RPM, dk red	C6ZZ-10B960CDR	\$434. ⁹⁵ SE
66	V8, 6000 RPM, ivy gold	C6ZZ-10B960CIG	\$434. ⁹⁵ SE
66	V8, 6000 RPM, lt blue	C6ZZ-10B960CLB	\$434. ⁹⁵ SE
66	V8, 6000 RPM, parch	C6ZZ-10B960CPA	\$434. ⁹⁵ SE
65-66	V8, 6000 RPM, satin	C6ZZ-10B960CSN	\$434. ⁹⁵ SE

1966 V8, 8,000 RPM

Year	Description	Part No.	List
65-66	V8, 8000 RPM, black	C6ZZ-10B960KBK	\$399. ⁹⁵ SE
65-66	V8, 8000 RPM, white	C6ZZ-10B960KWT	\$444. ⁹⁵ SE
66	V8, 8000 RPM, aqua	C6ZZ-10B960KAQ	\$444. ⁹⁵ SE
66	V8, 8000 RPM, dk red	C6ZZ-10B960KDR	\$444. ⁹⁵ SE
66	V8, 8000 RPM, ivy gold	C6ZZ-10B960KIG	\$444. ⁹⁵ SE
66	V8, 8000 RPM, lt blue	C6ZZ-10B960KLB	\$444. ⁹⁵ SE
66	V8, 8000 RPM, parch	C6ZZ-10B960KPA	\$444. ⁹⁵ SE
65-66	V8, 8000 RPM, satin	C6ZZ-10B960KSN	\$444. ⁹⁵ SE

1966 6 CYL, 6,000 RPM

Year	Description	Part No.	List
65-66	6 cyl., 6000 RPM, black	C6ZZ-10B960TBK	\$389. ⁹⁵ SE
65-66	6 cyl., 6000 RPM, white	C6ZZ-10B960TWT	\$434. ⁹⁵ SE
66	6 cyl., 6000 RPM, aqua	C6ZZ-10B960TAQ	\$434. ⁹⁵ SE
66	6 cyl., 6000 RPM, dk red	C6ZZ-10B960TDR	\$434. ⁹⁵ SE
66	6 cyl., 6000 RPM, ivy gold	C6ZZ-10B960TIG	\$434. ⁹⁵ SE
66	6 cyl., 6000 RPM, lt blue	C6ZZ-10B960TLB	\$434. ⁹⁵ SE
66	6 cyl., 6000 RPM, parch	C6ZZ-10B960TPA	\$434. ⁹⁵ SE
65-66	6 cyl., 6000 RPM, satin	C6ZZ-10B960TSN	\$434. ⁹⁵ SE

1967 UNDER DASH GAUGE POD

ASSEMBLY



We are proud to have the Scott Drake name on this Gauge Pod Assembly, an authentic reproduction of the original 1967 Shelby under dash gauge pod! Features Stewart Warner green line gauges and a tough, crinkle coated housing. Includes oil pressure & Amp gauges, mounting bracket, face plate, and all hardware and connectors needed for proper installation. Fits 1967 Shelby and 1967-68 Mustangs without center console. Universal fit for other under dash applications may also be possible

Year	Description	Part No.	List
67-68	Black	S7MS-10B969-A	\$474. ⁹⁵ SE

1967 UNDER DASH GAUGE POD

BRACKET



Never before available. We have reproduced the hanging bracket for the under dash gauge pod originally found in the 1967 Shelby. Made of heavy duty steel with exact detail and painted flat black.

Year	Part No.	List
67	S7MS-3676-A	\$34. ⁹⁵ EA

1967 UNDER DASH GAUGE POD

FACE PLATE



We have reproduced the original face plate for the 1967 Shelby underdash gauge pod. Features black wrinkle finish just like the original.

Year	Part No.	List
67	S7MS-17187-A	\$34. ⁹⁵ EA

1967-68 DASH GAUGE POD FACE

PLATE



Replaces factory radio bezel allowing you to run additional gauges. Made from sturdy ABS plastic.

Year	Part No.	List
67-68	C8ZZ-18842-GS	\$65. ⁹⁵ EA

RALLY PAC CENTER DIAL



Chrome plated dial ornament.

Year	Part No.	List
66	C6ZZ-10C858-D	\$7. ⁹⁵ EA

RALLY PAC DUAL GAUGE HOUSING



Rally Pac housing and bezels are now available without gauges so that you may add your favorite gauges for a custom project. Our housing can be mounted on the steering column or under the dash with the use of various brackets, available separately. Modifications are required to make aftermarket 2 5/16 inch gauges fit our housing and bezels. Included in this package are 2 chrome inner bezel rings and 2 gauge mounting compression rings.

Year	Description	Part No.	List
65-68	Black	S7MS-10B960-BK	\$199. ⁹⁵ EA
65-68	Satin	S7MS-10B960-S	\$209. ⁹⁵ EA
65-68	White	S7MS-10B960-WT	\$209. ⁹⁵ EA

RALLY PAC LENSES



Fabricated plastic construction.

Year	Description	Part No.	List
65	Clock	C5ZZ-15000-L	\$17. ⁹⁵ EA
65	Tach	C5ZZ-17360-L	\$22. ⁹⁵ EA
66	Clock	C6ZZ-15000-L	\$17. ⁹⁵ EA
66	Tach	C6ZZ-17306-L	\$22. ⁹⁵ EA

RALLY PAC MOUNTING CLAMP



Holds rally pack to steering column. Stamped steel and painted black. Includes rubber pad and mounting screws.

Year	Part No.	List
65	C5ZZ-3676-A	\$19. ⁹⁵ EA

RALLY PAC MOUNTING KIT



Includes mounting clamp, wire channel cover, rubber pad and mounting hardware. This kit is included when purchasing our new RallyPac.

Year	Description	Part No.	List
66	Black	C6ZZ-3678-AK	\$35. ⁹⁵ KI
66	White	C6ZZ-3678-WK	\$39. ⁹⁵ KI

RALLY PAC REPAIR PIGTAIL KIT



This repair harness is used to replace Rally-Pacs with damaged leads. Kit includes clock and tach harness plus four crimp on connectors.

Year	Part No.	List
64-65	C5ZZ-15A006-FX	\$25. ⁹⁵ KI
65-66	C6ZZ-15A006-FX	\$25. ⁹⁵ EA

**RALLY PAC THEFT PROTECTION
SCREW**



Design especially for rally-pac mounting. These specialty screws will slow down any thief. Kit includes two black button-head

socket screws, lock washers and special tool to install and remove.

Year	Part No.	List
64-66	379773-S	\$10.95 ^{KI}

RALLY PAC TRIM RING



Chrome plated plastic trim ring. Sold individually. Fits original rally pacs only.

Year	Part No.	List
66	C6ZZ-10C858-A	\$18.95 ^{EA}

RALLY PAC UNDER DASH HARNESS



Harness that plugs into main under dash harness. This harness must be used when installing a Rally Pac in a car that did not originally come with one.

Year	Part No.	List
64-66	CSZZ-15A006-UD	\$26.95 ^{EA}

DASH PANEL & GLOVEBOX

SHELBY TACH DASH BRACKET



Concours correct reproduction with wrinkle finish. Stamped steel.

Year	Part No.	List
66	S2MS-17360-B	\$30.95 ^{EA}

CENTER DASH RADIO MOLDING



ABS trim pieces for each side of the radio.

Year	Part No.	List
69-70	C9ZZ-6504472/3	\$28.95 ^{PR}

DASH PANEL TRIM



ABS trim pieces that mount on outboard sides of dash near the kick panels.

Year	Description	Part No.	List
69-70	Trim molding	C9ZZ-6504718	\$20.95 ^{PR}

RADIO BEZEL



Year	Description	Part No.	List
67-68	Black/chrome, w/out console	C8ZZ-18842-AR	\$59.95 ^{EA}



69-70: Black/chrome
C9ZZ-6504774-B

List
\$32.95^{EA}



69-70: Walnut woodgrain
C9ZZ-6504774-F

List
\$44.95^{EA}



71-73: Black/chrome
D1ZZ-18842-A

List
\$84.95^{EA}

RADIO AND HEATER BEZEL INSERT



Wood vinyl covering for radio and heater bezels. Walnut.

Year	Description	Part No.	List
69-70	Wood vinyl	WG-130-V	\$8.50 ^{SE}

DELUXE HEATER DASH PLATE & KNOB KIT



This complete Kit features our beautiful Chrome Plated Die-cast Heater Plate and Knobs as well as unique Retaining Brackets, Threaded Mounting Studs and Nuts for a trouble free Installation.

Description	Part No.	Year	List
Chrome	CSZZ-18A651-KIT	64-66	\$43.95 ^{KIT}

HEATER DASH RETAINERS



A very special retainer required to install heater dash plate.

Year	Description	Part No.	List
64-66	Zinc	C40A-18580-A	\$7.95 ^{PR}

HEATER & AC CONTROL KNOBS

These exact reproductions are a great finishing touch. Made from die cast zinc and heavily chrome plated for durability. Black and chrome lettering on 64-68 versions is crisp and clear. 69-70 are chrome plated plastic like original.



64-66: Heater, chrome
C5DZ-18519-K

List

\$16.95^{SE}



64-66: Heater, satin
C5DZ-18519-KS

List

\$17.95^{SE}



67: AC
C7ZZ-18519-ACK

List

\$24.95^{SE}



67: Non A/C
C7ZZ-18519-AK

List

\$24.95^{SE}



68: AC
C8ZZ-18519-ACK

List

\$24.95^{SE}



68: Non A/C
C8ZZ-18519-AK

List

\$24.95^{SE}



69-70: Heater
C9ZZ-18519-A

List

\$14.95^{SE}

AC VENT

Replacement air conditioning vents for the instrument panel.



67-68: RH side
C7ZZ-19893-A

List

\$172.50^{EA}



67: LH side, includes knobs
C7ZZ-19C696-A

List

\$192.50^{EA}



68: LH side, includes knobs
C8ZZ-19C696-A

List

\$192.50^{EA}

Interior

**WE PROUDLY FEATURE AUTHENTIC MUSTANG
REPRODUCTIONS FROM SCOTT DRAKE!**



STANDARD DASH PANEL



Our standard dash panels are quality injection molded plastic, chrome plated and then screened black. For standard interiors. Dash Panel, Standard

Year	Description	Part No.	List
67-68	3 piece set	C7ZZ-6504410-K	\$52. ⁹⁵ SE
67-68	Lower	C7ZZ-65044A10-D	\$14. ⁹⁵ EA
67-68	Upper	C7ZZ-65044A90-B	\$24. ⁹⁵ EA
67-68	Center	C7ZZ-6504774-B	\$12. ⁹⁵ EA

DASH PANEL BEZEL



New by Scott Drake is our 1969-70 Mustang Mach 1 Deluxe Right Hand Dash Bezel. Our panel is a beautiful reproduction that

is ready for your clock, light and wood grain insert panel. Attractively finished in mat-black with chrome accents but more importantly we improved it with stronger mounting points!

Year	Description	Part No.	List
69-70	Deluxe, Mach, & Grande	C9ZZ-6504338-B	\$169. ⁹⁵ EA
71-73	Black, RH	D1ZZ-10838-RH	\$99. ⁹⁵ EA

DASH PANEL BEZEL



Our deluxe dash panels are quality injection molded plastic, chrome plated. Available without inserts so you can add your

own, or with inserts already installed! Our aluminum inserts are real brushed aluminum, and our woodgrain inserts are vinyl with metal backing to prevent shrinking. For Deluxe interiors.

Year	Description	Part No.	List
67-68	Complete 3-piece deluxe dash trim w/out inserts	C7ZZ-65044A10WO	\$114. ⁹⁵ SE
67-68	Upper w/out insert	C7ZZ-65044A90-A	\$61. ⁹⁵ EA
67-68	Lower w/out insert	C7ZZ-65044A10-C	\$29. ⁹⁵ EA
67-68	Center w/out insert	C7ZZ-6504774-A	\$22. ⁹⁵ EA

1967-68 DELUXE DASH PANEL



67: 3 piece set w/ aluminum inserts
C7ZZ-6504410-KR

List
\$144.⁹⁵ SE

67: Upper w/ aluminum insert
C7ZZ-65044A90AR

List

\$84.⁹⁵ EA

67: Aluminum AC vent inserts (adhesive not included)
C7ZZ-6504410-AC

List

\$29.⁹⁵ SE

68: 3 piece set w/ metal backed woodgrain inserts
C8ZZ-6504410-KR

List

\$144.⁹⁵ SE

68: w/ metal backed woodgrain inserts, for cars w/ AC
C8ZZ-6504410-AC

List

\$99.⁹⁵ SE

DASH PANEL HEATER CONTROL PLATE INSERT



Real brushed aluminum inserts, or vinyl woodgrain with metal backing inserts. These are perfect matches to our other dash panel inserts.

Year	Description	Part No.	List
67	Brushed Aluminum, w/out AC	C7ZZ-6504410-HC	\$13. ⁹⁵ EA
68	Metal backed woodgrain, w/out AC	C8ZZ-6504410-HC	\$14. ⁹⁵ EA

DELUXE DASH PANEL INSERT

These vinyl inserts are made to be installed on dash and instrument panel. Vinyl versions are adhesive backed. Clear silicone adhesive is recommended for metal backed.



68: Metal-backed woodgrain, 4 piece set, w/out AC
WG-102-M

List

\$74.⁹⁵ SE



68: Vinyl woodgrain, 7 piece set, w/ or w/out AC
WG-128-V

List

\$19.⁹⁵ KI



68: Vinyl woodgrain, 9 piece set, w/ or w/out AC
WG-129-V

List

\$25.⁹⁵ KI

1969 DELUXE WALNUT DASH INSERTS



Beautiful new 1969 Mach 1, Deluxe and Grande walnut woodgrain dash inserts are now available exclusively from Scott

Drake. Due to the extreme difficulty in manufacturing them, these rare panels have never before been available. These are complete stamped steel panels with the woodgrain finish permanently attached. NOTE: Some early 69 cars had teak inserts which are not available. Sold in pairs only for a perfect match.

Year	Description	Part No.	List
69	Walnut metal backed	C9ZZ-10838-WMIK	\$334. ⁹⁵ EA

DASH PANEL EMBLEM

Excellent reproductions.



67-68: Running Horse, red & silver, very small 7/8"x3/8", Adhesive backed
C7ZZ-65044A90-E



List

\$3.⁹⁵ EA



67-68: Running horse tri-bar emblem w/ base, For Deluxe interior
C7ZZ-65044A90EP



List

\$34.⁹⁵ EA



67-68: Running Horse tri-bar emblem w/out base, for Deluxe Interior
C7ZZ-65044A90-M



List

\$19.⁹⁵ EA



67-68: Running horse base only, for Deluxe interior
C7ZZ-65044A90-P

List

\$14.⁹⁵ EA



69-70: Outer chrome bezel only
C9ZZ-6304460

List

\$26.⁹⁵ EA



69-70: Mach 1, Insert only
C9ZZ-6304460-AI

List

\$18.⁹⁵ EA



69-70: Mustang, insert only
C9ZZ-6304460-BI



List

\$18.⁹⁵ EA

 69-70: Grande, Insert only
C9ZZ-6304460-GI

List
\$19.⁹⁵ EA



 71-73: Mustang script, except Grande
D1ZZ-6504774-EM

List
\$15.⁹⁵ EA



 69-70: Cobra GT 350
S9MS-6304460-A

List
\$14.⁹⁵ EA



 69-70: Cobra Jet GT 500
S9MS-6304460-B

List
\$14.⁹⁵ EA



 67: Shelby GT350 Grille, dash or deck
S7MS-16098-C

List
\$54.⁹⁵ EA



 67: Shelby GT500 Grille, dash or deck
S7MS-16098-D

List
\$54.⁹⁵ EA



 68: Cobra Jet
S8MS-6304460-E

List
\$64.⁹⁵ EA



TIRE PRESSURE DECAL



This decal came installed on the inside of the glove box door and charted the tire information. See Decal section for complete offerings.

Year	Part No.	List
66	DF-19	\$3. ⁹⁵ EA
67-68	DF-282	\$3. ⁹⁵ EA

GLOVE BOX DOOR



Excellent reproductions, pressure die cast zinc with show car chrome & a correct horse emblem.

These are chromed much better than others. Ours are also the only ones with the correct swedging of the horse & correct woodgrain color.

Year	Description	Part No.	List
64-65	Black, w/ emblem	CSZZ-6506024-A	\$99. ⁹⁵ EA
64-65	Standard, black, w/ out emblem	CSZZ-6506024-AE	\$84. ⁹⁵ EA



Year	Description	Part No.	List
65	GT, standard, black, w/ emblem	CSZZ-6506024-B	\$99. ⁹⁵ EA
65	GT, standard, black, w/out emblem	CSZZ-6506024-BE	\$84. ⁹⁵ EA



Year	Description	Part No.	List
65-66	Deluxe, metal-backed woodgrain, w/ emblem	CSZZ-6506024-C	\$99. ⁹⁵ EA
65-66	Deluxe, woodgrain, w/out emblem	CSZZ-6506024-CE	\$84. ⁹⁵ EA



Year	Description	Part No.	List
66	Standard, black, w/ emblem	C6ZZ-6506024-A	\$99. ⁹⁵ EA
66	Standard, black, w/ out emblem	C6ZZ-6506024-AE	\$84. ⁹⁵ EA



Year	Part No.	List
67-68	C7ZZ-6506024-B	\$104. ⁹⁵ EA

GLOVE BOX DOOR HINGE

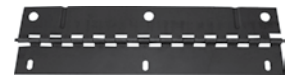

Year	Part No.	List
67-68	C7ZZ-6506050-A	\$19. ⁹⁵ EA

GLOVE BOX EMBLEM



Pressure die cast, excellent reproductions. Perfect chrome, stripes are painted correct colors.

Year	Description	Part No.	List
64-65	Running horse, curved	C4ZB-65060A14-A	\$9. ⁹⁵ EA
65-66	Running horse, flat	CSZB-65060A14-A	\$9. ⁹⁵ EA

GLOVE BOX

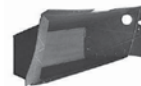

1964-1966 & 1971-1973 Precision die cut black chipboard construction just as originals. 1967-1968 Plastic injection.

Year	Description	Part No.	List
64-66	Black, chipboard w/ lens	CSZZ-6506010-A	\$12. ⁹⁵ EA
64-66	Black, flocked	CSZZ-6506010-FB	\$25. ⁹⁵ EA
64-66	Gray, flocked	CSZZ-6506010-FG	\$25. ⁹⁵ EA
66	Black, chipboard, concours w/ clip & hole for flasher	C6ZZ-6506010-A	\$19. ⁹⁵ EA
67-68	Black, plastic	C7ZZ-6506010-A	\$41. ⁹⁵ EA
69-70	W/ AC	C9ZZ-6506010-AC	\$29. ⁹⁵ EA
69-70	W/out AC	C9ZZ-6506010-B	\$29. ⁹⁵ EA
71-73	Black, chipboard, w/ out AC	D1ZZ-6506010-A	\$12. ⁹⁵ EA
71-73	Black, chipboard, w/ AC	D1ZZ-6506010-B	\$12. ⁹⁵ EA

GLOVE BOX SCREW KIT



Correct broad head screws with black finish.

Year	Part No.	List
64-66	382086-SK	\$2. ⁵⁰ KI

Interior

WE PROUDLY FEATURE AUTHENTIC MUSTANG REPRODUCTIONS FROM SCOTT DRAKE!



GLOVE BOX LATCH



A great optional accessory from Scott Drake. All new tooling was created to produce our glovebox latches. Also available as a locking version with keys.

Year	Description	Part No.	List
64-65	Standard, Curved door	CSZZ-6506072-A	\$18 ⁹⁵ EA
65-66	Deluxe, flat door	CSZZ-6506072-B	\$18 ⁹⁵ EA
67-68	Standard	C6DZ-6506072-A	\$18 ⁹⁵ EA
69-70	Standard	C9ZZ-6506072-A	\$18 ⁹⁵ EA

GLOVE BOX LOCK



A great optional accessory from Scott Drake. All new tooling was created to produce our glovebox latches. Includes 2 matching keys.

Year	Description	Part No.	List
64-65	Standard, curved door	CSZZ-6506072-AL	\$21 ⁹⁵ SE
65-66	Deluxe, flat door	CSZZ-6506072-BL	\$21 ⁹⁵ SE
67-68	Standard	C6DZ-6506072-AL	\$21 ⁹⁵ EA
69-70	Standard	C9ZZ-6506072-AL	\$21 ⁹⁵ SE

GLOVE BOX STRIKER SET



Exact reproduction of the original. Hardware included.

Part No.	Year	Description	List
CSZZ-6506064-A	64-66	Zinc	\$7 ⁹⁵ SE
CSZZ-6506064-C	64-66	Chrome	\$8 ⁹⁵ SE

GLOVE BOX BUTTON BEZEL



Commonly missing. Made of stainless steel.

Year	Part No.	List
67-68	C60B-62060A12	\$6 ⁹⁵ EA

GLOVE BOX OR TRUNK LOCK SET



New from Scott Drake. All new tooling was created to produce our glovebox latches. This kit allows use of the same key for both the glovebox and trunk lock.

Year	Part No.	List
67-68	C6DZ-6506072-K	\$34 ⁹⁵ SE
69-70	C9ZZ-6506072-K	\$34 ⁹⁵ SE

GLOVE BOX DOOR CABLE



Cable with correct ends and mounting screws. Supports glove box door when opened.

Year	Part No.	List
65-66	CSZZ-65060A08-A	\$7 ⁵⁰ KI

GLOVE BOX DOOR INSERTS



A nice wood applique to replace that worn, cracked or faded surface on 1965 and 1966 Pony

glove box doors. See our Instrument Panel section, later in this catalog, for matching instrument panel inserts.

Year	Description	Part No.	List
65-66	Woodgrain, metal backed	CSZZ-65060A24	\$20 ⁹⁵ EA
65-66	Woodgrain, vinyl sticker	WG-125-V	\$10 ⁹⁵ EA

GLOVE BOX LAMP



Correct wire pigtail. Bulb included. **New improved tooling.**

Year	Part No.	List
64-68	CSZZ-14413-A	\$19 ⁹⁵ EA

DOOR PANEL

INSIDE DOOR HANDLES

Excellent reproductions of the originals, fit is perfect. All of these handles feature a brightly polished, chrome finish or our custom satin chrome finish.



64- Early 65
RH or LH, Chrome
C3AZ-6222600-B

List
\$11⁹⁵ EA



Late 65-67
RH or LH, Chrome
Will not fit 67 Deluxe
CSZZ-6522600-C

List
\$11⁹⁵ EA



Late 65-67
RH or LH, Satin
CSZZ-6522600-S

List
\$13⁹⁵ EA



65-66
Deluxe, Chrome Woodgrain
CSZZ-6522600-A (RH)
CSZZ-6522601-A (LH)

List
\$22⁰⁰ EA



Year	Description	Part No.	List
65-66	Deluxe leather with chrome finish, pair	C7ZZ-6522600-A	\$44 ⁹⁵ PR



This is a Scott Drake exclusive. Made to fit the 1967 Deluxe door panel. Yes, they were different. Made with the same attention to detail and quality of our other interior door handles. You must use this handle when installing deluxe door panels.

Year	Description	Part No.	List
67	Deluxe RH & LH	C7ZZ-6522600-A	\$22 ⁹⁵ EA



Year	Description	Part No.	List
68 RH	Chrome	C7AZ-5422600-B	\$22 ⁹⁵ EA
68 LH	Chrome	C7AZ-5422601-B	\$22 ⁹⁵ EA
68 RH	Satin	C7AZ-5422600-S	\$26 ⁹⁵ EA
68 LH	Satin	C7AZ-5422601-S	\$26 ⁹⁵ EA



Excellent reproductions featuring a brightly polished, chrome finish.

Year	Description	Part No.	List
69-70	RH	C9AZ-6222600-A	\$22 ⁹⁵ EA
69-70	LH	C9AZ-6222601-A	\$22 ⁹⁵ EA



Excellent reproductions featuring a brightly polished, chrome finish. Fits Mach1 and Deluxe interiors..

Year	Description	Part No.	List
71-73	Deluxe RH	D1ZZ-6522600-A	\$22 ⁹⁵ EA
71-73	Deluxe LH	D1ZZ-6522601-A	\$22 ⁹⁵ EA

DOOR SHAFT ASSEMBLY



Gold cadmium plated and made from our own tooling. Our 64-66 standard interior shafts will accommodate early clip-on handles.

Year	Description	Part No.	List
64-66	Standard, RH	CSZZ-6521818-C	\$14. ⁹⁵ EA
64-66	Standard, LH	CSZZ-6521819-C	\$14. ⁹⁵ EA
65-66	Pony, RH	CSZZ-6521818-B	\$14. ⁹⁵ EA
65-66	Pony, LH	CSZZ-6521819-B	\$14. ⁹⁵ EA
67-68	RH	C60Z-6221818-B	\$14. ⁹⁵ EA
67-68	LH	C60Z-6221819-B	\$14. ⁹⁵ EA

UNIVERSAL DOOR WINDOW REGULATOR



Good quality universal style Year both screw on and clip on style window cranks. Same high quality as our concours regulators but with a specially designed shaft that will fit both styles of cranks. 1 year warranty.

Year	Description	Part No.	List
64-66	Universal, RH	CSZZ-6523202-E	\$29. ⁹⁵ EA
64-66	Universal, LH	CSZZ-6523203-E	\$29. ⁹⁵ EA

64-66 CONCOURS DOOR WINDOW REGULATORS



Excellent replacement, silver cadmium plated to prevent rust. Engineered for a perfect fit. Will not self destruct like others.

These are the finest available. They feature original metal thickness on body, large gear and swing arm, high tension spring to ease in operation, correct threads, splined shaft, exact dimensions as original for proper handle alignment, extra strong internal gear with improved rivets. Attractively boxed and a 2 year warranty. 1964 version is clip-on style, 65-66 version is screw-on style.

Year	Description	Part No.	List
64	Concours, RH	CSZZ-6523202-A	\$34. ⁹⁵ EA
64	Concours, LH	CSZZ-6523203-A	\$34. ⁹⁵ EA
65-66	Concours, RH	CSZZ-6523202-B	\$34. ⁹⁵ EA
65-66	Concours, LH	CSZZ-6523203-B	\$34. ⁹⁵ EA

67-68 CONCOURS DOOR WINDOW REGULATORS



Made by Scott Drake, 67-68 Concours Window Regulators. These window regulators are painted black, like the originals. Available for either the RH or LH side.

Year	Description	Part No.	List
67	Concours, RH	C7ZZ-6523200-AR	\$64. ⁹⁵ EA
67	Concours, LH	C7ZZ-6523201-AR	\$64. ⁹⁵ EA
68	Concours, RH	C8ZZ-6523200-AR	\$64. ⁹⁵ EA
68	Concours, LH	C7ZZ-6523201-AR	\$64. ⁹⁵ EA

69-73 DOOR WINDOW REGULATOR



Quality reproductions.

Year	Description	Part No.	List
69	RH	C7ZZ-6523200-AR	\$64. ⁹⁵ EA
69	LH	C7ZZ-6523201-AR	\$64. ⁹⁵ EA
70	RH	C8ZZ-6523200-AR	\$64. ⁹⁵ EA
70	RH	C7ZZ-6523200-AR	\$64. ⁹⁵ EA
71-73	LH	C7ZZ-6523201-AR	\$64. ⁹⁵ EA
71-73	RH	C8ZZ-6523200-AR	\$64. ⁹⁵ EA

WINDOW REGULATOR RETAINER CLIP



Secures window regulator to scissor mechanism.

Year	Part No.	List
64-66	353745-S	\$1. ⁵⁰ KI

WINDOW REGULATOR SCISSOR ASSEMBLY



Very nice copy of scissor assembly that allows door glass to move up and down.

Year	Description	Part No.	List
64-66	LH	CSZZ-6523234-L	\$34. ⁹⁵ EA
64-66	RH	CSZZ-6523234-R	\$34. ⁹⁵ EA

QUARTER WINDOW REGULATOR



Cadmium plated to prevent rust. Engineered for a perfect fit. Will not self destruct like others.

Year	Description	Part No.	List
64-67	LH	CSZZ-6530306-L	\$59. ⁹⁵ EA
64-67	RH	CSZZ-6530306-R	\$59. ⁹⁵ EA
68	LH	C8ZZ-6530306-L	\$59. ⁹⁵ EA
68	RH	C8ZZ-6530306-R	\$59. ⁹⁵ EA
69-70	LH	C9ZZ-6530306-L	\$79. ⁹⁵ EA
69-70	RH	C9ZZ-6530306-R	\$79. ⁹⁵ EA
71-73	LH	D1ZZ-6530306-L	\$79. ⁹⁵ EA
71-73	RH	D1ZZ-6530306-R	\$79. ⁹⁵ EA

WINDOW ROLLER & CLIP



Used on door and quarter window regulators scissors. Replacement makes window glass move easier. Now made by Drake this part features correct blue color and correct shape wire clip to prevent "pop offs" like other reproductions.

Year	Part No.	List
64-68	COAB-6423240-B	\$1. ⁰⁰ EA

LUBRICANT



This is a thick-bodied spray lubricant. Recommended for metal-to-metal moving parts. Clings to sprayed areas for lasting lubrication. Excellent for window regulators and hinges on doors, trunk and hood. Supplied in 16 ounce spray cans.

Year	Description	Part No.	List
64-73	White grease, aerosol can	CRL-715	\$9. ⁵⁰ EA

DOOR WINDOW CRANK

Highly detailed die-cast zinc construction. Finished in beautiful chrome or satin. Our handle feature much better detail than others.



64-65
Early 65, chrome
C4SZ-6323342-A

List

\$11.⁹⁵ EA



65-67
Late 65, chrome
CSZZ-6523342-C

List

\$11.⁹⁵ EA



65-67
Late 65, satin
CSZZ-6523342-S

List

\$13.⁹⁵ EA

WE PROUDLY FEATURE AUTHENTIC MUSTANG REPRODUCTIONS FROM SCOTT DRAKE!



135

Interior



68-70
Chrome
C8AZ-6223342-A

List
\$11.95^{EA}



68-70
Chrome w/black knob
C8AZ-6223342-BK

List
\$18.95^{EA}



68-70
Satin
C8AZ-6223342-S

List
\$13.95^{EA}



1971-72
(Will also fit 1973): Chrome
C9UZ-8223342

List
\$11.95^{EA}

QUARTER WINDOW CRANK

Quarter window crank handle, made by Scott Drake. Like all our handles, these feature better detail and better chrome than competitors.



64-65
Early 65, chrome
C4SZ-6530322-A

List
\$13.95^{EA}



65-67
Late 65, chrome
C5ZZ-6530322-A

List
\$13.95^{EA}



65-67
Late 65, satin
C5ZZ-6530322-S

List
\$15.95^{EA}



68-70
Chrome
C8ZZ-6530322-A

List
\$11.95^{EA}



68-70
Chrome w/Black Knobs
C8ZZ-6530322-BK

List
\$18.95^{EA}

INSIDE DOOR HANDLE & WINDOW CRANK SCREW

We have these exact reproductions made especially for us. You want to use right parts, not something "close". 65-66 are chrome plated just like the originals. Sold in sets of 4. See Hardware section for bulk.



65-66
Set of 4
379259-S

List
\$4.00^{SE}



67-70
Set of 4
381571-S

List
\$1.95^{SE}

DOOR HANDLE & WINDOW CRANK SPRING



Black lacquer finished to prevent rust. fits behind door panel

Year	Part No.	List
64-67	B7A-7022624-A	\$1.25 ^{EA}

DOOR HANDLE CLIP REMOVER



Removes special retaining clip on early door handles and window cranks. Stamped steel construction.

Year	Part No.	List
64-65	T-87600	\$7.95 ^{EA}

DOOR HANDLE SPRING CLIP



Small spring clip, copper plated just like the originals. Used to attach door handle and window crank to door shaft.

Year	Part No.	List
64-65	357550-S	\$0.30 ^{EA}

PONY DOOR HANDLE BACKING PLATE



Die cast and chrome plated. New improved design is very wear resistant. Also included are nylon bushings to prevent scratches.

Year	Description	Part No.	List
65-66	Chrome	C4SY-6322620/1A	\$10.95 ^{SE}
65-66	Satin	C4SY-6322620/1S	\$11.95 ^{PR}

WHITE, INSIDE WINDOW CRANK & DOOR HANDLE BACKING PLATE



Protects door panels from the abrasive action of rotating handles. Made from a very hard nylon type material. Ours feature the correct milky white color.

Year	Description	Part No.	List
64	Door	C3AZ-6223370-A	\$0.90 ^{EA}
65-70	Door	C5AZ-6223370-A	\$0.90 ^{EA}
64-67	Qtr windw	C4SZ-6323370-A	\$0.90 ^{EA}
68-73	Door	C8AZ-6223370-A	\$0.90 ^{EA}

CHROME, INSIDE WINDOW CRANK BACKING PLATE



The original plates are either missing, cracked or no longer chrome. Our plates are made with a bright chrome finish to really catch the eye.

Year	Description	Part No.	List
69-70	Chrome	C9ZZ-6523370-A	\$9.95 ^{PR}

WINDOW CRANK HANDLE COVER PLATE



This is a aluminum disc that covers the window crank handle screw hole. Stamped aluminum with circular brushed finish and adhesive backed.

Year	Part No.	List
68-73	C8AZ-6223362-A	\$1.25 ^{EA}

WINDOW CRANK KNOB



A premium reproduction. The knob is vinyl-molded and has a plastic insert just like the original. Mounting pin & wave washer also included. will not fit original 1973 handles.

Year	Description	Part No.	List
68-72	Black	C8AZ-6223352-BK	\$6.95 ^{EA}
68-72	Blue	C8AZ-6223352-BL	\$7.50 ^{EA}
68-70	Clear/Silver	C8AZ-6223352-CL	\$7.50 ^{EA}
68-72	Ginger	C8AZ-6223352-GI	\$7.50 ^{EA}
68-72	Green	C8AZ-6223352-GR	\$7.50 ^{EA}
68-70	Ivy Gold	C8AZ-6223352-IG	\$7.50 ^{EA}
68-70	Maroon	C8AZ-6223352-MR	\$7.50 ^{EA}
68-69	Parchment & Nug Gold	C8AZ-6223352-PR	\$7.50 ^{EA}
68-72	Vermillion	C8AZ-6223352-VE	\$7.50 ^{EA}
68-72	White	C8AZ-6223352-WT	\$7.50 ^{EA}

DOOR LOCK KNOB GROMMET

The grommet that goes around the door lock knob, comes in clear, chrome or stainless.



64½: All
Black plastic
C20Z-6221999-BK

List

\$4.95 EA



65-68: All 69-73
Standard interior Clear plastic
CSDZ-6221999-B

List

\$0.75 EA



65-68: All 69-73
Standard interior Chrome
CSDZ-6221999-C

List

\$3.50 PR



69-73
Deluxe interior Stainless steel
DODZ-6221999-AR

List

\$6.95 PR

DOOR LOCK KNOB

Made by Plastic injection. Sold as a pair. Available in chrome, or satin chrome.



64½
Black
C3AZ-6221850-BK

List

\$7.50 EA



65-66
Chrome
CSDZ-6221850-A

List

\$5.00 PR



65-66
Satin chrome
CSDZ-6221850-S

List

\$5.00 PR



67
Chrome
C5AZ-6221850-A

List

\$6.00 PR



68-73
Chrome, concours
C8AZ-6221850-A

List

\$5.00 PR

DOOR PANELS & ARMRESTS

ARM REST BASE AND PAD KIT



Each kit contains a pair of arm rest pads and bases. Arm rest pads feature correct texture and molded in color. Steel insert for strength. Extra thick vinyl skin. Base is precision molded of stress resistant plastic with a smooth chrome finish. Kit includes all mounting screws.

Part No.	Year	Description	List
KIT-INT-2-BK	64-66	Black	\$29.95 KI
KIT-INT-2-BL	64-66	Medium blue	\$29.95 KI
KIT-INT-2-BR	64-65	Bright red	\$29.95 KI
KIT-INT-2-DB	66	Dark blue	\$29.95 KI
KIT-INT-2-DR	66	Dark red	\$29.95 KI
KIT-INT-2-WT	64-65	White	\$29.95 KI

1964-66 ARM REST PAD



Correct texture and molded-in colors, with steel insert molded into foam to increase strength. Extra thick vinyl skins. American made. See "Hardware" section for special mounting screws and retaining clip.

Year	Description	Part No.	List
64-66	Black	C5ZZ-6524100-BK	\$10.95 EA
66	Aqua	C5ZZ-6524100-AQ	\$10.95 EA
64-65	Medium blue	C5ZZ-6524100-BL	\$10.95 EA
64-65	Bright red	C5ZZ-6524100-BR	\$10.95 EA
66	Dark blue	C5ZZ-6524100-DB	\$10.95 EA
66	Dark red	C5ZZ-6524100-DR	\$10.95 EA
64-66	Ivy gold	C5ZZ-6524100-IG	\$10.95 EA
64-65	Palomino	C5ZZ-6524100-PA	\$10.95 EA
66	Parchment	C5ZZ-6524100-PR	\$10.95 EA
64-65	White	C5ZZ-6524100-WT	\$10.95 EA

1967 ARM REST PAD



Correct texture and molded-in colors, with steel insert molded into foam to increase strength. Extra thick vinyl skins. American made. See "Hardware" section for special mounting screws and retaining clip.

Year	Desc	Part No.	List
67	Black	C7ZZ-6524100-BK	\$19.95 EA
67	Red	C7ZZ-6524100-RD	\$19.95 EA
67	Blue	C7ZZ-6524100-BL	\$19.95 EA
67	Aqua	C7ZZ-6524100-AQ	\$23.95 EA
67	Ivy gold	C7ZZ-6524100-IG	\$23.95 EA
67	Parchment	C7ZZ-6524100-PR	\$23.95 EA
67	Saddle	C7ZZ-6524100-SA	\$23.95 EA

1968 ARM REST PAD



Correct texture and molded-in colors, with steel insert molded into foam to increase strength. Extra thick vinyl skins. American made. See "Hardware" section for special mounting screws and retaining clip.

Year	Description	Part No.	List
68	Black, RH	C8ZZ-6524100-BK	\$23.95 EA
68	Black, LH	C8ZZ-6524101-BK	\$23.95 EA
68	Red, RH	C8ZZ-6524100-RD	\$23.95 EA
68	Red, LH	C8ZZ-6524101-RD	\$23.95 EA
68	Blue, RH	C8ZZ-6524100-BL	\$23.95 EA
68	Blue, LH	C8ZZ-6524101-BL	\$23.95 EA
68	Aqua, RH	C8ZZ-6524100-AQ	\$26.95 EA
68	Aqua, LH	C8ZZ-6524101-AQ	\$26.95 EA
68	Ivy gold, RH	C8ZZ-6524100-IG	\$26.95 EA
68	Ivy gold, LH	C8ZZ-6524101-IG	\$26.95 EA
68	Parchment, RH	C8ZZ-6524100-PR	\$26.95 EA
68	Parchment, LH	C8ZZ-6524101-PR	\$26.95 EA
68	Saddle, RH	C8ZZ-6524100-SA	\$26.95 EA
68	Saddle, LH	C8ZZ-6524101-SA	\$26.95 EA

ARM REST BASE TO DOOR PANEL SCREW



Cadmium plated truss head screws. Just like original. 4 Piece Set.

Year	Part No.	List
64-66	377905-S	\$2.95 SE

ARM REST RETAINING CLIPS



Very unique clips, exact copies of the originals.

Year	Part No.	List
64-66	BA-7024146-A	\$2.95 PR
67-68	C7AB-6224146-C	\$2.95 PR

Interior

WE PROUDLY FEATURE AUTHENTIC MUSTANG REPRODUCTIONS FROM SCOTT DRAKE!



137

1968 DELUXE ARM REST PAD



Correct texture and molded-in colors, with steel insert molded into foam to increase strength. Extra thick vinyl skins. American made. See left for retaining clip. Plugs sold separately.

Year	Description	Part No.	List
68	Black, RH	C8ZZ-6524100BKD	\$64. ⁹⁵ EA
68	Black, LH	C8ZZ-6524101BKD	\$64. ⁹⁵ EA
68	Blue, RH	C8ZZ-6524100BLD	\$66. ⁹⁵ EA
68	Blue, LH	C8ZZ-6524101BLD	\$66. ⁹⁵ EA
68	Aqua, RH	C8ZZ-6524100AQD	\$66. ⁹⁵ EA
68	Aqua, LH	C8ZZ-6524100AQD	\$66. ⁹⁵ EA
68	Ivy gold, RH	C8ZZ-6524100IGD	\$66. ⁹⁵ EA
68	Ivy gold, LH	C8ZZ-6524101IGD	\$66. ⁹⁵ EA
68	Maroon, RH	C8ZZ-6524100MRD	\$66. ⁹⁵ EA
68	Maroon, LH	C8ZZ-6524101MRD	\$66. ⁹⁵ EA
68	Parchment, RH	C8ZZ-6524100PRD	\$66. ⁹⁵ EA
68	Parchment, LH	C8ZZ-6524101PRD	\$66. ⁹⁵ EA
68	Saddle, RH	C8ZZ-6524100SAD	\$66. ⁹⁵ EA
68	Saddle, LH	C8ZZ-6524101SAD	\$66. ⁹⁵ EA

1969-70 ARM REST PAD



Correct texture and molded-in colors, with steel insert molded into foam to increase strength. Extra thick vinyl skins. American made. Note: Ford used 2 different arm rest pads in 69-70. We currently offer only 1 version. Mounting holes are approximately 12 1/4" from center to center on our pads. Some cars measured approximately 13". These cars will require relocating one mounting hole before door panel is installed.

Year	Description	Part No.	List
69-70	Black, RH	C9ZZ-6524100-BK	\$34. ⁹⁵ EA
69-70	Black, LH	C9ZZ-6524101-BK	\$34. ⁹⁵ EA
69-70	White, RH	C9ZZ-6524100-WT	\$39. ⁹⁵ EA
69-70	White, LH	C9ZZ-6524101-WT	\$39. ⁹⁵ EA

1971-73 ARM REST PAD

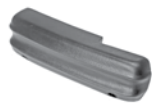

Correct texture and molded-in colors, with steel insert molded into foam to increase strength. Extra thick vinyl skins. American made.

Year	Description	Part No.	List
71-73	Black, RH	D1ZZ-6524100-BK	\$24. ⁹⁵ EA
71-73	Black, LH	D1ZZ-6524101-BK	\$24. ⁹⁵ EA
71-73	Blue, RH	D1ZZ-6524100-BL	\$24. ⁹⁵ EA
71-73	Blue, LH	D1ZZ-6524101-BL	\$24. ⁹⁵ EA
71-73	Ginger, RH	D1ZZ-6524100-GI	\$24. ⁹⁵ EA
71-73	Ginger, LH	D1ZZ-6524101-GI	\$24. ⁹⁵ EA

ARM REST PAD BASE



Year	Description	Part No.	List
71-73	Standard interior	D1AZ-5724144-A	\$13. ⁹⁵ EA

DELUXE ARM REST PLUG



Perfect detail in these often missing plugs. 67's fit into door panel, 68's fit into arm rest pad.

Year	Description	Part No.	List
67	Black, deluxe	C7ZZ-6524056-BK	\$6. ⁹⁵ PR
67	Parchment, deluxe	C7ZZ-6524056-PR	\$6. ⁹⁵ PR
68	Black, deluxe, set of 4	C8ZZ-6524056-BK	\$7. ⁹⁵ ST
68	Parchment, deluxe, set of 4	C8ZZ-6524056-PR	\$7. ⁹⁵ ST

DOOR WATERSHIELD



Protects door panels and upholstery from water damage. Specially treated paper, precisely die-cut for an easy installation. CRL-7708 Sealer recommended for installation (can be found towards the end of "Door Parts").

Part No.	Year	Description	List
C5ZZ-63-WS	65-66	Fastback	\$10. ⁹⁵ KI
C5ZZ-65-WS	64-66	Coupe	\$14. ⁵⁰ KI
C5ZZ-76-WS	64-66	Convertible	\$14. ⁵⁰ KI
C7ZZ-63-WS	67-68	Fastback	\$10. ⁹⁵ KI
C7ZZ-65-WS	67-68	Coupe	\$14. ⁵⁰ KI
C7ZZ-76-WS	67-68	Convertible	\$14. ⁵⁰ PR
C9ZZ-63-WS	69-70	Fastback	\$10. ⁹⁵ KI
C9ZZ-65-WS	69-70	Coupe	\$14. ⁵⁰ KI
C9ZZ-76-WS	69-70	Convertible	\$14. ⁵⁰ KI
D1ZZ-63-WS	71-73	Fastback	\$14. ⁵⁰ SE
D1ZZ-65-WS	71-73	Coupe	\$14. ⁵⁰ SE
D1ZZ-76-WS	71-73	Convertible	\$14. ⁵⁰ SE



For TMI Door Panels see page 168

1964-65 STANDARD DOOR PANELS



Our door panels are upholstered with the original material, mounted on precision die-cut fiberboard. Colors and textures are identical to the originals. Includes chrome plated plastic trim where appropriate.



Year	Description	Part No.	List
64-65	Black	CSZZ-65239423BK	\$74. ⁹⁵ PR
64-65	Blue	CSZZ-65239423BL	\$74. ⁹⁵ PR
64-65	Ivy gold	CSZZ-65239423IG	\$74. ⁹⁵ PR
64-65	Palamino	CSZZ-65239423PA	\$74. ⁹⁵ PR
64-65	Red	CSZZ-65239423RD	\$74. ⁹⁵ PR
64-65	White	CSZZ-65239423WT	\$74. ⁹⁵ PR

1965-66 DELUXE DOOR PANELS



These panels are the finest available. Excellent molded vinyl surface with the correct grain. Foam filled on treated pressboard. These door panels DO NOT include stainless steel trim pieces.



Year	Description	Part No.	List
65-66	Black	CSZZ65239423BKP	\$179. ⁹⁵ PR
66	Dark red	CSZZ65239423DRP	\$179. ⁹⁵ PR
66	Parchment	CSZZ65239423PRP	\$179. ⁹⁵ PR
65	Bright red	CSZZ65239423RDP	\$179. ⁹⁵ PR
65-66	White	CSZZ65239423WTP	\$179. ⁹⁵ PR

1966 STANDARD DOOR PANELS



Our door panels are upholstered with the original material, mounted on precision die-cut fiberboard. Colors and textures are identical to the originals. Includes chrome plated plastic trim where appropriate.



Year	Description	Part No.	List
66	Black	C6ZZ-65239423BK	\$74. ⁹⁵ PR
66	Aqua	C6ZZ-65239423AQ	\$74. ⁹⁵ PR
66	Blue	C6ZZ-65239423BL	\$74. ⁹⁵ PR
66	Dark red	C6ZZ-65239423DR	\$74. ⁹⁵ PR
66	Parchment	C6ZZ-65239423PR	\$74. ⁹⁵ PR

1967 STANDARD DOOR PANELS



Our door panels are upholstered with the original material, mounted on precision die-cut fiberboard. Colors and textures are

identical to the originals. Includes chrome plated plastic trim where appropriate.

Year	Description	Part No.	List
67	Black	C7ZZ-65239423BK	\$74. ⁹⁵ PR
67	Aqua	C7ZZ-65239423AQ	\$74. ⁹⁵ PR
67	Blue	C7ZZ-65239423BL	\$74. ⁹⁵ PR
67	Ivy gold	C7ZZ-65239423IG	\$74. ⁹⁵ PR
67	Parchment	C7ZZ-65239423PR	\$74. ⁹⁵ PR
67	Red	C7ZZ-65239423RD	\$74. ⁹⁵ PR
67	Saddle	C7ZZ-65239423SA	\$74. ⁹⁵ PR

1967 DELUXE DOOR PANELS



These panels are the finest available. Excellent molded vinyl surface with the correct grain. Foam filled on treated

pressboard. These door panels do not include stainless steel trim pieces, or aluminum inserts.

Year	Description	Part No.	List
67	Black	C7ZZ65239423BKD	\$209. ⁹⁵ PR
67	Blue	C7ZZ65239423BLD	\$209. ⁹⁵ PR
67	Ivy gold	C7ZZ65239423IGD	\$209. ⁹⁵ PR
67	Parchment	C7ZZ65239423PRD	\$209. ⁹⁵ PR
67	Red	C7ZZ65239423RDD	\$209. ⁹⁵ PR

1965-67 2-TONE STANDARD DOOR PANELS



Two-tone panels are available in a variety of color combinations. 1967 panels will fit 1968 cars.



Year	Description	Part No.	List
65	Blue/white	C5ZZ65239423B/W	\$109. ⁹⁵ PR
65	Black/white	C5ZZ65239423BK/W	\$102. ⁵⁰ PR
65	Ivy gold/white	C5ZZ65239423I/W	\$109. ⁹⁵ PR
65	Palamino/white	C5ZZ65239423P/W	\$109. ⁹⁵ PR
65	Bright red/white	C5ZZ65239423R/W	\$109. ⁹⁵ PR
66	Aqua/white	C6ZZ65239423A/W	\$109. ⁹⁵ PR
66	Blue/white	C6ZZ65239423B/W	\$109. ⁹⁵ PR
66	Black/white	C6ZZ65239423BK/W	\$109. ⁹⁵ PR
66	Light blue/white	C6ZZ65239423LB/W	\$109. ⁹⁵ PR
66	Parchment/white	C6ZZ65239423P/W	\$109. ⁹⁵ PR
66	Dark red/white	C6ZZ65239423R/W	\$109. ⁹⁵ PR
67	Aqua/white	C7ZZ65239423A/W	\$109. ⁹⁵ PR
67	Blue/white	C7ZZ65239423B/W	\$109. ⁹⁵ PR
67	Black/white	C7ZZ65239423BK/W	\$109. ⁹⁵ PR
67	Ivy gold/white	C7ZZ65239423I/W	\$109. ⁹⁵ PR
67	Parchment/white	C7ZZ65239423P/W	\$109. ⁹⁵ PR
67	Dark red/white	C7ZZ65239423R/W	\$109. ⁹⁵ PR
67	Saddle/white	C7ZZ65239423S/W	\$109. ⁹⁵ PR

1968 STANDARD DOOR PANELS



Our door panels are upholstered with the original material, mounted on precision

die-cut fiberboard. Colors and textures are identical to the originals. Includes chrome plated plastic trim where appropriate.



Year	Description	Part No.	List
68	Black	C8ZZ-65239423BK	\$74. ⁹⁵ PR
68	Blue	C8ZZ-65239423BL	\$74. ⁹⁵ PR
68	Ivy gold	C8ZZ-65239423IG	\$74. ⁹⁵ PR
68	Maroon	C8ZZ-65239423MR	\$74. ⁹⁵ PR
68	Nugget gold	C8ZZ-65239423NG	\$74. ⁹⁵ PR
68	Parchment	C8ZZ-65239423PR	\$74. ⁹⁵ PR
68	Saddle	C8ZZ-65239423SA	\$74. ⁹⁵ PR

1968 DELUXE DOOR PANELS



These panels are the finest available. Chrome trim and woodgrain inserts installed as original.



Year	Description	Part No.	List
68	Black	C8ZZ65239423BKD	\$174. ⁹⁵ PR
68	Aqua	C8ZZ65239423AQD	\$174. ⁹⁵ PR
68	Blue	C8ZZ65239423BLD	\$174. ⁹⁵ PR
68	Ivy gold	C8ZZ65239423IGD	\$174. ⁹⁵ PR
68	Maroon	C8ZZ65239423MRD	\$174. ⁹⁵ PR
68	Nugget gold	C8ZZ65239423NGD	\$174. ⁹⁵ PR
68	Parchment	C8ZZ65239423PRD	\$174. ⁹⁵ PR
68	Saddle	C8ZZ65239423SAD	\$174. ⁹⁵ PR

1969 STANDARD DOOR PANELS



Our door panels are upholstered with the original material, mounted on precision die-cut

fiberboard. Colors and textures are identical to the originals. Includes chrome plated plastic trim where appropriate.



Year	Description	Part No.	List
69	Black	C9ZZ-65239423BK	\$76. ⁹⁵ PR
69	Dark ivy gold	C9ZZ-65239423DI	\$76. ⁹⁵ PR
69	Dark red	C9ZZ-65239423DR	\$76. ⁹⁵ PR
69	Light blue	C9ZZ-65239423LB	\$76. ⁹⁵ PR
69	Nugget gold	C9ZZ-65239423NG	\$76. ⁹⁵ PR
69	White	C9ZZ-65239423WT	\$76. ⁹⁵ PR

1969-70 DELUXE DOOR PANELS



These panels are the finest available. Excellent molded vinyl surface with the correct grain.

Foam filled on treated pressboard. Carpet installed. These door panels do not include stainless steel trim pieces, or aluminum inserts. Some cutting may be required.



Year	Description	Part No.	List
69	Black w/ black carpet	C9ZZ65239423BKD	\$404. ⁹⁵ PR
69	Dark red w/ maroon carpet	C9ZZ65239423DRD	\$409. ⁹⁵ PR
69	White w/ black carpet	C9ZZ65239423WTD	\$404. ⁹⁵ PR
70	Med blue w/ blue carpet	C9ZZ65239423BLD	\$409. ⁹⁵ PR
70	Black w/ black carpet	D0ZZ65239423BKD	\$404. ⁹⁵ PR
70	Ginger w/ drk brown carpet	D0ZZ65239423GID	\$404. ⁹⁵ PR
70	White w/ black carpet	D0ZZ65239423WTD	\$404. ⁹⁵ PR

WE PROUDLY FEATURE AUTHENTIC MUSTANG REPRODUCTIONS FROM SCOTT DRAKE!



1970 STANDARD DOOR PANELS



Our door panels are upholstered with the original material, mounted on precision die-cut fiberboard. Colors and textures are

identical to the originals. Includes chrome plated plastic trim where appropriate.

Part No.	Year	Description	List
DOZZ-65239423BK	70	Black	\$106 ⁹⁵ PR
DOZZ-65239423BL	70	Blue	\$106 ⁹⁵ PR
DOZZ-65239423BR	70	Bright red	\$106 ⁹⁵ PR
DOZZ-65239423IG	70	Ivy gold	\$106 ⁹⁵ PR
DOZZ-65239423WT	70	White	\$106 ⁹⁵ PR

1971-73 STANDARD DOOR PANELS



Our door panels are upholstered with the original material, mounted on precision die-cut fiberboard. Colors and

textures are identical to the originals. Includes chrome plated plastic trim where appropriate.



Part No.	Year	Description	List
D1ZZ-65239423BK	71-73	Black	\$114 ⁹⁵ PR
D1ZZ-65239423BL	71-73	Blue	\$114 ⁹⁵ PR
D1ZZ-65239423BR	71-73	Bright red	\$114 ⁹⁵ PR
D1ZZ-65239423GI	71-73	Ginger	\$114 ⁹⁵ PR
D1ZZ-65239423GR	71-73	Green	\$114 ⁹⁵ PR
D1ZZ-65239423IG	71-73	Ivy gold	\$114 ⁹⁵ PR
D1ZZ-65239423WT	71-73	White	\$114 ⁹⁵ PR

1971-73 DELUXE DOOR PANELS



These panels are the finest available. Excellent molded vinyl surface with the correct grain. Foam filled on treated

pressboard. Carpet installed. These door panels do not include stainless steel trim pieces, or aluminum inserts.



Year	Description	Part No.	List
71-73	Black	D1ZZ65239423BKD	\$434 ⁹⁵ PR
71-73	Medium blue	D1ZZ65239423BLD	\$434 ⁹⁵ PR
71-73	Ginger	D1ZZ65239423GID	\$434 ⁹⁵ PR
71-73	White	D1ZZ65239423WTD	\$434 ⁹⁵ PR

DOOR PANEL CLIPS



High quality door panel clips in bulk or nicely packaged in a set of 30. 64-68 requires 30 clips, 69-70 requires 28 clips, and 71-73 requires 20. Standard clips are also used for seat backs.

Year	Description	Part No.	List
64-70	Standard, set of 30, also Year 68 Deluxe	380552-K	\$9 ⁹⁵ SE
64-73	Standard, bulk, also Year 68 Deluxe	380552-S	\$0 ³⁵ EA
65-67	Deluxe, set of 30	375553-K	\$11 ⁹⁵ SE
65-67	Deluxe, bulk	375553-S	\$0 ⁴⁰ EA
69-70	Deluxe screws & clips, set of 36	375553-69D	\$10 ⁹⁵ SE

ARM REST BASE



Precision molded of stress-resistant plastic, with a smooth durable chrome finish. See "Hardware" section for special mounting screws and retaining clip.

Part No.	Year	List
CSZZ-6524144-A	64-66	\$5 ⁹⁵ EA

1964-67 DELUXE DOOR PANEL CUPS



Perfect and color match. Ours are double dipped in textured vinyl just like originals.

Part No.	Year	Description	List
CSZZ-6524142-BK	65-67	Black	\$10 ⁹⁵ EA
CSZZ-6524142-BR	65	Bright red	\$12 ⁹⁵ EA
CSZZ-6524142-DR	66-67	Dark red	\$12 ⁹⁵ EA
CSZZ-6524142-PR	66-67	Parchment	\$12 ⁹⁵ EA
CSZZ-6524142-WT	65-66	White	\$10 ⁹⁵ EA

DELUXE DOOR PANEL KIT



Kit includes pads, cups, brackets and mounting hardware.

Year	Description	Part No.	List
65-66	Black	KIT-INT5-BK	\$32 ⁹⁵ KI
65-66	White	KIT-INT5-WT	\$32 ⁹⁵ KI

STANDARD DOOR PANEL CUP



Black plastic cup with correct texture and chrome beauty rings.

Year	Description	Part No.	List
69-70	Standard interior	C9ZZ-65226A34	\$22 ⁹⁵ SE

DELUXE DOOR HANDLE BEZEL



Trim behind door handle. Mounts on door before door panel is installed.

Year	Description	Part No.	List
69-70	Deluxe interior	C9ZZ-6522634-D	\$25 ⁹⁵ PR

DELUXE DOOR PANEL CUP BRACKET



New pressure die cast zinc construction just like the originals, but stronger. Some reproductions are flimsy plastic.

Year	Description	Part No.	List
69	Black, pair	C9ZZ6524046/7BK	\$54 ⁹⁵ PR
69	White, pair	C9ZZ6524046/7WT	\$54 ⁹⁵ PR
69	Black, RH	C9ZZ-6524046-BK	\$34 ⁹⁵ EA
69	Black, LH	C9ZZ-6524047-BK	\$34 ⁹⁵ EA
69	White, LH	C9ZZ-6524047-WT	\$34 ⁹⁵ EA
70	Black, pair	DOZZ-6524046/7B	\$54 ⁹⁵ PR
70	White, pair	DOZZ-6524046/7W	\$54 ⁹⁵ PR

DELUXE DOOR PANEL CUP BRACKET



This support bracket is used to fasten the Pony door cups to the inner door on 1965-67 Deluxe interiors. It takes two of these per car.

Year	Part No.	List
65-67	CSZZ-6524140	\$4 ⁵⁰ EA



New by Drake, this set of 1969 and 1970 Deluxe Arm Rest Brackets is made from the original Ford Factory Prints and feature attached threaded studs for an easier and more secure installation. Sold as a pair with all necessary hardware is included. Used in conjunction with Deluxe Door Cups.

Year	Part No.	List
69	C9ZZ-65240A10-A	\$19 ⁹⁵ KI
70	DOZZ-65240A10-B	\$19 ⁹⁵ KI

DOOR PANEL CUP PAD



Textured rubber pad that covers the door cup mounting screws. Correct color match.

Year	Description	Part No.	List
65-67	Black	C5SZ-6324046-BK	\$3.95 ^{EA}
66-67	Parchment	C5SZ-6324046-PR	\$3.95 ^{EA}
65-66	White	C5SZ-6324046-WT	\$3.95 ^{EA}
69	Black	C9ZB-6524046/7B	\$12.95 ^{PR}
69	White	C9ZB-6524046/7W	\$12.95 ^{PR}
70	Black	D0ZB-6524046/7B	\$12.95 ^{PR}
70	White	D0ZB-6524046/7W	\$12.95 ^{PR}

DOOR PANEL U-CUP



Now made by Drake, these are great reproductions. Made from ABS plastic, these cups feature the

correct texture on the inside and mounting pins just like the originals.

Year	Description	Part No.	List
67	Deluxe Interior, Black	C7ZZ-6524148-BK	\$44.95 ^{PR}
67	Deluxe Interior, Parchment	C7ZZ-6524148-PR	\$44.95 ^{PR}

DELUXE DOOR PULL



Exact reproduction of the originals. Exact detail of stitches and grain pattern.

Year	Description	Part No.	List
68	Black, pair	C8ZZ-6526656-BK	\$29.95 ^{PR}
68	Dark blue, pair	C8ZZ-6526656-BL	\$29.95 ^{PR}
68	Parchment, pair	C8ZZ-6526656-PR	\$29.95 ^{PR}
68	Saddle, pair	C8ZZ-6526656-SA	\$29.95 ^{PR}



Year	Description	Part No.	List
71-73	Black, LH	D1ZZ-6526655-BK	\$56.95 ^{EA}
71-73	Blue, LH	D1ZZ-6526655-BL	\$56.95 ^{EA}
71-73	Ginger, LH	D1ZZ-6526655-GI	\$56.95 ^{EA}
71-73	Black, RH	D1ZZ-6526656-BK	\$56.95 ^{EA}
71-73	Blue, RH	D1ZZ-6526656-BL	\$56.95 ^{EA}
71-73	Ginger, RH	D1ZZ-6526656-GI	\$56.95 ^{EA}

DOOR PULL END CAP KIT



Our door pull end caps feature beautiful chrome and wood grain insert that matches the dash and door panel wood grain. We

feel these look a lot nicer than the original. All mounting hardware included. Inner door braces sold separately.

Year	Description	Part No.	List
68	Deluxe interior	C7WY-6522670/6	\$42.95 ^{SE}

WOODGRAIN DOOR PULL INSERTS



These are the same inserts that are available in our complete door pull end cap kit, but now available on their own. Quickly and

easily replace worn or missing inserts. Sold as a set of 4 inserts.

Year	Description	Part No.	List
68	Set of 4	C7WY-6522670-A	\$8.95 ^{SE}

INNER DOOR PULL BRACE



Exact reproduction. Includes mounting hardware and nylon inserts. Painted black.

Year	Description	Part No.	List
68	Deluxe interior	C8AZ-6522606-A	\$16.95 ^{SE}

DOOR SPEAKER GRILLES

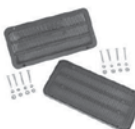

65-66
C6ZZ-18798-A

List
\$50.95^{PR}



69-70
Stereo script
C9ZZ-18798-A

List
\$44.95^{PR}



71-73
D2ZZ-18978-A

List
\$29.95^{EA}

1967-68 DOOR SPEAKER GRILLES

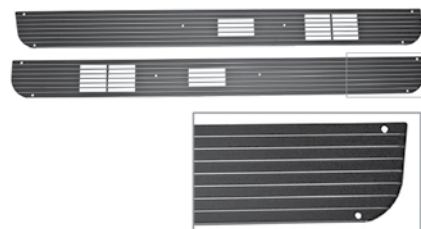

Made by Scott Drake, these 1967-68 Deluxe Door Speaker Grilles are a beautiful reproduction. They can also be installed on 1965-66 doors for a custom look. Use our Door Grille Mounting Kit (C7ZN-3301) for proper installation on doors originally equipped with these grilles.

Year	Description	Part No.	List
67-68	Deluxe, also fits 65-66	C7ZZ-6520956/7A	\$124.95 ^{PR}

DOOR COURTESY LIGHT ASSEMBLY

These assemblies feature bright white lenses, beautiful chrome plating, correct wiring and housing. Mounting hardware included. These are the best on the market. See "Electrical" for wire harness.

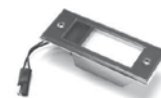

65-66
Deluxe
C5ZZ-13786

List
\$34.95^{EA}



67-68
Deluxe
C7ZB-13A744-C

List
\$32.50^{EA}



69-70
Deluxe, set of 2
C9WY-13776/7-A

List
\$79.95^{PR}

DOOR COURTESY LIGHT LENS



Replace those yellowed lenses with our clean white reproduction. Sold in matching pairs.

Year	Description	Part No.	List
67-68	Deluxe	C7ZZ-13731-B	\$19.95 ^{PR}

WE PROUDLY FEATURE AUTHENTIC MUSTANG REPRODUCTIONS FROM SCOTT DRAKE!



DOOR SILL

ORIGINAL FORD TOOLING SILL PLATES



Made by original Ford supplier. Concourse quality.

Perfect fit. Heavy gauge aluminum. Emblem not included.

Year	Description	Part No.	List
64-68	Coupe/Fastback	CSZZ-6513208-BP*	\$42.95 ^{EA}
64-68	Convertible	CSZZ-7613208*	\$42.95 ^{EA}

REPRODUCTION SILL PLATES



New improved stampings, which are thicker than

previous reproductions. These new stampings are stronger and stiffer. Polished aluminum. Emblem not included.

Year	Description	Part No.	List
64-68	Coupe/Fastback	CSZZ-6513208-B	\$17.95 ^{EA}
64-68	Convertible	CSZZ-7613208-C	\$18.95 ^{EA}
69-70	All	C9ZZ-6513208-A	\$19.95 ^{EA}
71-73	All	D1ZZ-6513208-A	\$20.95 ^{EA}

STAINLESS STEEL SILL PLATES



A Scott Drake exclusive! These plates are stamped

to look like original scuff plates but feature highly-polished stainless steel. These are heavy-gauge scuff plates and will not dent or scratch like other aluminum versions. Our plates also feature slotted mounting holes for quick and easy installation.

Year	Description	Part No.	List
65-68	Coupe/Fastback	CSZZ-6513208-SS	\$72.95 ^{PR}
64-68	Convertible	CSZZ-7613208-SS	\$74.95 ^{PR}

LIGHTED SILL PLATES



These sill plates are constructed of 304 stainless steel, not lightweight aluminum. We also gave it a bright, polished finish, and added brushed GT type stripes for a retro look that will keep it looking great for years. Additionally featured is a custom logo with a cool blue luminescent light that glows when the doors are opened. In daylight or at night, our lighted sill plates will turn heads. Simple installation makes this a "must have" part for your Mustang.

Year	Description	Part No.	List
64-68	Coupe/Fastback, blue	CSZZ-6513208-HL	\$129.95 ^{SE}
64-68	Convertible, blue	CSZZ-7613208-HL	\$129.95 ^{SE}

SILL PLATE EMBLEM

This aluminum emblem mounts on the center of all scuff plates. Features raised script like original, adhesive backed & protective coating.



64-66: Black, Ford logo
CSZZ-6513208-T

List

\$2.50^{EA}



67-73: Blue, Ford logo
C7ZZ-6513208-T

List

\$2.50^{EA}



68-73: Blue, Ford logo
C8ZZ-6513208-T

List

\$2.50^{EA}



65-66: Shelby
S1MS-6513208-T

List

\$19.95^{PR}

SILL PLATE SCREW



Oval head #8 Chrome plated screws. Repair kit is for stripped out holes.

Year	Description	Part No.	List
64-70	Bulk	376290-S	\$0.30 ^{EA}
64-68	Set of 18	376290-SK	\$4.50 ^{SE}
64-70	Repair kit #8 head with #10 threads	376290-SK	\$4.50 ^{PR}

STAINLESS STEEL ACCESSORY SILL PLATE



A Ford accessory designed to protect paint on rocker. Stainless steel construction.

Year	Description	Part No.	List
64-68	Coupe/Fastback	CSZZ-6513242-A	\$49.95 ^{PR}
69-70	All	C9ZZ-6513242-A	\$48.95 ^{PR}

MAGIC MAT INSULATION



- **2mm Thickest Material (vs 1.7mm)**
- **Mil-Spec Construction**
- **Reduces Noise and Vibration**
- **Reduces Noise and Vibration**
- **Insulates from extreme heat and cold**
- **Water and oil resistant**
- **Available in Silver or Black**
- **Easy Installation with self-adhesive backing**

This Premium Sound Deadening Insulation was originally developed for Military use in Europe. Thick 2mm construction out performs leading Competitors that uses 1.7mm sheets. This material excels in insulating temperatures both hot and cold, sound proofing, noise dampening and eliminating resonance and vibrations. Very easy to apply self-adhesive 20" x 29" sheets that form to almost any contoured shapes and cuts easily with quality scissors or razor blade. Ideal for Floor Pans, Firewall, Doors, Roof and Trunks. Not affected by water or oil and adhesive it functional between -45c to 100c. This product is used in many high dollar European Cars and high dollar Car Audio installations and a great way to make your old Classic car more comfortable to ride in. Manufacturer is certified ISO 9001 and rated Q1 by Ford. Available in the standard Silver Foil as well as a Black Foil with an attractive pattern than can be left exposed such as the inside of trunk area. 9 sheets per box for a total of 36 Square Feet.

Year	Description	Part No.	List
64-73	Silver Magic 2mm	UL-SM	\$114.95 ^{KIT}
64-73	Black Magic 2.3mm	UL-BM	\$119.95 ^{KIT}

FIREWALL INSULATOR



Features bonded thermal insulation. Mounting kit included. Choose from die cut for a good fit or Molded for a perfect fit.

Year	Description	Part No.	List
64-66	Die-cut Economy	CSZZ-6501670-A	\$56 ⁹⁵ EA
67-68	Die-cut Economy	C7ZZ-6501670-A	\$56 ⁹⁵ EA
67-68	All Molded	C7ZZ-6501670-M	\$134 ⁹⁵ EA
67-68	All Molded	C7ZZ-6501670-M	\$134 ⁹⁵ EA

SOUND DEADENER KIT



All made with die cut precision that makes them easy to install. Drastically reduces road noise and helps insulate your car from the heat and cold. Includes all pieces originally available for you particular year and bodystyle. Made from E.V.A. Our most complete kit. Kits include the following: L.H. and R.H. Front, Center Trans Hump, Rear Floor, Under Rear Seat, Transition and Trunk sections. 7 piece kit.

Year	Description	Part No.	List
64-68	Coupe	UL-CP	\$79 ⁹⁵ KI
69-73	Coupe	UL-CP-L	\$79 ⁹⁵ KI
64-68	Convertible	UL-CV	\$75 ⁹⁵ KI
69-73	Convertible	UL-CV-L	\$75 ⁹⁵ KI
65-68	Fastback	UL-FB	\$79 ⁹⁵ KI
69-73	Fastback	UL-FB-L	\$79 ⁹⁵ KI

CARPET UNDERLAYMENT KIT



Kits include heavy duty die cut E.V.A. type rubber pad which aids against carpet ware, especially around sharp contoured floor areas. Helps insulate sound and temperature.

Year	Description	Part No.	List
64-73:	Coupe/Fastback, front and rear footwells	UL-1	\$42 ⁹⁵ KI
64-73:	Convertible, front and rear footwells	UL-3	\$42 ⁹⁵ KI



64-73: trans hump
UL-4

List

\$14⁵⁰ EA



65-68: Trunk
UL-5

List

\$16⁹⁵ EA

CARPET & FLOOR MATS

COUPE CARPET KIT



This is the good stuff. 1964-1968 are constructed from 80% Rayon 20 % Nylon, 1969-1970 are

100% Nylon. All edges are sewn to prevent unraveling. Drivers side has molded, colored keyed rubber heel and toe pad. All carpet is backed with a heavy 27 ounce jute insulation layer. Also features a precut gearshift hole. Fastbacks include small lower quarter panel sections.

Year	Description	Part No.	List
64	Black	CAR64-CP-BK	\$154 ⁹⁵ SE
64	Red	CAR64-CP-BR	\$154 ⁹⁵ SE
64	Dark blue	CAR64-CP-DB	\$154 ⁹⁵ SE
65-66	Dark teal	CAR65-6-CP-DT	\$154 ⁹⁵ SE
65-68	Aqua	CAR65-CP-AQ	\$154 ⁹⁵ SE
65-68	Bright blue	CAR65-CP-BB	\$154 ⁹⁵ SE
65-68	Black	CAR65-CP-BK	\$154 ⁹⁵ SE
65-68	Dark brown	CAR65-CP-BN	\$154 ⁹⁵ SE
65-68	Red	CAR65-CP-BR	\$154 ⁹⁵ SE
65-68	Dark blue	CAR65-CP-DB	\$154 ⁹⁵ SE
65-68	Dark green	CAR65-CP-DG	\$154 ⁹⁵ SE
65-68	Dark saddle	CAR65-CP-DS	\$154 ⁹⁵ SE
65-68	Emberglow	CAR65-CP-EM	\$154 ⁹⁵ SE
65-68	Ivy gold	CAR65-CP-IG	\$154 ⁹⁵ SE
65-68	Maroon	CAR65-CP-MR	\$154 ⁹⁵ SE
65-68	Nugget gold	CAR65-CP-NG	\$154 ⁹⁵ SE
65-68	Saddle	CAR65-CP-SA	\$154 ⁹⁵ SE
71-73	Black	CAR71-CP-BK	\$154 ⁹⁵ SE
71-73	Blue	CAR71-CP-BL	\$154 ⁹⁵ SE
71-73	Bright red	CAR71-CP-BR	\$154 ⁹⁵ SE
71-73	Dark green	CAR71-CP-DG	\$154 ⁹⁵ SE
71-73	Ginger	CAR71-CP-GI	\$154 ⁹⁵ SE
69-70	Maroon	CAR69-CP-MR	\$154 ⁹⁵ SE
69-70	Vermillion	CAR69-CP-VE	\$154 ⁹⁵ SE
71-73	Black	CAR71-CP-BK	\$154 ⁹⁵ SE
71-73	Blue	CAR71-CP-BL	\$154 ⁹⁵ SE
71-73	Bright red	CAR71-CP-BR	\$154 ⁹⁵ SE
71-73	Dark green	CAR71-CP-DG	\$154 ⁹⁵ SE
71-73	Ginger	CAR71-CP-GI	\$154 ⁹⁵ SE

ECONOMY CARPET KIT



These are quality molded carpet sets made from 100% nylon, and available at a lower price than our standard carpet kits. Available for 65-68 coupes, convertibles, and fastbacks.

Year	Description	Part No.	List
65-68	Coupe, black	CAR-65-CP-BK-N	\$149 ⁹⁵ SE
65-68	Convertible, black	CAR-65-CV-BK-N	\$149 ⁹⁵ SE
65-68	Fastback, black	CAR-65-FB-BK-N	\$149 ⁹⁵ SE

FASTBACK CARPET KIT



This is the good stuff. 1964-1968 are constructed from 80% Rayon 20 %

Nylon, 1969-1970 are 100% Nylon. All edges are sewn to prevent unraveling. Drivers side has molded, colored keyed rubber heel and toe pad. All carpet is backed with a heavy 27 ounce jute insulation layer. Also features a precut gearshift hole. Fastbacks include small lower quarter panel sections.

Year	Description	Part No.	List
65-68	Aqua	CAR65-FB-AQ	\$159 ⁹⁵ SE
65-68	Bright blue	CAR65-FB-BB	\$159 ⁹⁵ SE
65-68	Black	CAR65-FB-BK	\$159 ⁹⁵ SE
65-68	Dark brown	CAR65-FB-BN	\$159 ⁹⁵ SE
65-68	Bright red	CAR65-FB-BR	\$159 ⁹⁵ SE
65-68	Dark blue	CAR65-FB-DB	\$159 ⁹⁵ SE
65-68	Dark green	CAR65-FB-DG	\$159 ⁹⁵ SE
65-68	Dark saddle	CAR65-FB-DS	\$159 ⁹⁵ SE
65-68	Ivy gold	CAR65-FB-IG	\$159 ⁹⁵ SE
65-68	Maroon	CAR65-FB-MR	\$159 ⁹⁵ SE
65-68	Nugget gold	CAR65-FB-NG	\$159 ⁹⁵ SE
65-68	Saddle	CAR65-FB-SA	\$159 ⁹⁵ SE
69-70	Black	CAR69-FB-BK	\$149 ⁹⁵ SE
69-70	Dark blue	CAR69-FB-DB	\$149 ⁹⁵ SE
69-70	Dark green	CAR69-FB-DG	\$149 ⁹⁵ SE
69-70	Ginger	CAR69-FB-GI	\$149 ⁹⁵ SE
69-70	Maroon	CAR69-FB-MR	\$149 ⁹⁵ SE
70	Vermillion	CAR69-FB-VE	\$149 ⁹⁵ SE
71-73	Black	CAR71-FB-BK	\$149 ⁹⁵ SE
71-73	Blue	CAR71-FB-BL	\$149 ⁹⁵ SE
71-73	Dark green	CAR71-FB-DG	\$149 ⁹⁵ SE
71-73	Ginger	CAR71-FB-GI	\$149 ⁹⁵ SE

FASTBACK FOLD DOWN SEAT CARPET



Made from the original 80/20 blended or 100% Nylon carpeting. Cut to fit.

Year	Description	Part No.	List
65-68	Black, 80/20	FD-65-BK	\$78 ⁹⁵ SE
66-68	Aqua, 80/20	FD-65-AQ	\$78 ⁹⁵ SE
65-68	Bright blue, 80/20	FD-65-BB	\$78 ⁹⁵ SE
65-68	Dark brown, 80/20	FD-65-BN	\$78 ⁹⁵ SE
65-68	Bright red, 80/20	FD-65-BR	\$78 ⁹⁵ SE
65-68	Dark blue, 80/20	FD-65-DB	\$78 ⁹⁵ SE
65-68	Dark green, 80/20	FD-65-DG	\$78 ⁹⁵ SE
65-68	Dark saddle, 80/20	FD-65-DS	\$78 ⁹⁵ SE
65-68	Ivy gold, 80/20	FD-65-IG	\$78 ⁹⁵ SE
66-68	Maroon, 80/20	FD-65-MR	\$78 ⁹⁵ SE

Interior

WE PROUDLY FEATURE AUTHENTIC MUSTANG REPRODUCTIONS FROM SCOTT DRAKE!



143

Year	Description	Part No.	List
65-68	Nugget gold, 80/20	FD-65-NG	\$78 ⁹⁵ SE
65-68	Saddle, 80/20	FD-65-SA	\$78 ⁹⁵ SE

65-68	Black, 100% nylon	FD-65-BK-N	\$74 ⁹⁵ SE
69-70	Black, 100% nylon	FD-69-BK	\$74 ⁹⁵ SE
69-70	Dark green, 100% nylon	FD-69-DG	\$74 ⁹⁵ SE
69-70	Ginger, 100% nylon	FD-69-GI	\$74 ⁹⁵ SE
69-70	Maroon, 100% nylon	FD-69-MR	\$74 ⁹⁵ SE
69-70	Vermillion, 100% nylon	FD-69-VE	\$74 ⁹⁵ SE
71-73	Black, 100% nylon	FD-71-BK	\$74 ⁹⁵ SE
71-73	Dark green, 100% nylon	FD-71-DG	\$74 ⁹⁵ SE
71-73	Ginger, 100% nylon	FD-71-GI	\$74 ⁹⁵ SE

CONVERTIBLE CARPET KIT



This is the good stuff. 1964-1968 are constructed from 80% Rayon 20 %

Nylon, 1969-1970 are 100% Nylon. All edges are sewn to prevent unraveling. Drivers side has molded, colored keyed rubber heel and toe pad. All carpet is backed with a heavy 27 ounce jute insulation layer. Also features a precut gearshift hole.

Year	Description	Part No.	List
64	Black	CAR64-CV-BK	\$154 ⁹⁵ SE
65-68	Aqua	CAR65-CV-AQ	\$154 ⁹⁵ SE
65-68	Bright blue	CAR65-CV-BB	\$154 ⁹⁵ SE
65-68	Black	CAR65-CV-BK	\$154 ⁹⁵ SE
65-68	Dark brown	CAR65-CV-BN	\$154 ⁹⁵ SE
65-68	Bright red	CAR65-CV-BR	\$154 ⁹⁵ SE
65-68	Dark blue	CAR65-CV-DB	\$154 ⁹⁵ SE
65-68	Dark green	CAR65-CV-DG	\$154 ⁹⁵ SE
65-68	Dark saddle	CAR65-CV-DS	\$154 ⁹⁵ SE
65-68	Emberglow	CAR65-CV-EM	\$154 ⁹⁵ SE
65-68	Ivy gold	CAR65-CV-IG	\$154 ⁹⁵ SE
65-68	Maroon	CAR65-CV-MR	\$154 ⁹⁵ SE
65-68	Nugget gold	CAR65-CV-NG	\$154 ⁹⁵ SE
65-68	Saddle	CAR65-CV-SA	\$154 ⁹⁵ SE
69-70	Black	CAR69-CP-BK	\$154 ⁹⁵ SE
69-70	Dark brown	CAR69-CV-BR	\$154 ⁹⁵ SE
69-70	Dark blue	CAR69-CV-DB	\$154 ⁹⁵ SE
69-70	Dark green	CAR69-CV-DG	\$154 ⁹⁵ SE
69-70	Ginger	CAR69-CV-GI	\$154 ⁹⁵ SE
69-70	Maroon	CAR69-CV-MR	\$154 ⁹⁵ SE
69-70	Vermillion	CAR69-CV-VE	\$154 ⁹⁵ SE
71-73	Black	CAR71-CV-BK	\$154 ⁹⁵ SE
71-73	Blue	CAR71-CV-BL	\$154 ⁹⁵ SE
71-73	Bright red	CAR71-CV-BR	\$154 ⁹⁵ SE
71-73	Dark green	CAR71-CV-DG	\$154 ⁹⁵ SE
71-73	Ginger	CAR71-CV-GI	\$154 ⁹⁵ SE

MACH 1 CARPET KIT

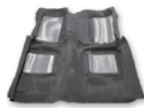

1969 has four rubber inserts just like originals, specify colors. 1970 has 2 rubber inserts. 1971-1973 have two rubber inserts with correct embossed horse.

Year	Description	Part No.	List
69	Black, w/ black inserts	CAR69-M-BK/BK	\$248 ⁹⁵ SE
69	Black, w/ red inserts	CAR69-M-BK/RD	\$248 ⁹⁵ SE
70	Black, w/ black inserts	CAR70-M-BK/BK	\$214 ⁹⁵ SE
70	Black, w/ gray inserts	CAR70-M-BK/GY	\$214 ⁹⁵ SE
70	Blue, w/ blue inserts	CAR70-M-BL/BL	\$214 ⁹⁵ SE
71-73	Black, w/ black inserts	CAR71-M-BK/BK	\$214 ⁹⁵ SE
71-73	Black, w/ gray inserts	CAR71-M-BK/GR	\$214 ⁹⁵ SE
71-73	Ginger, w/ ginger inserts	CAR71-M-GI/GI	\$214 ⁹⁵ SE

EMBROIDERED, MUSTANG CARPET FLOOR MATS FROM ACC

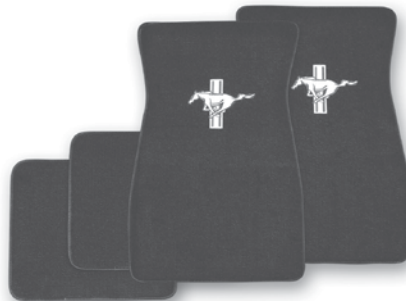

Made by Auto Custom Carpet out of the same 80/20 blend as our 1964 - 1968 carpet for a perfect match. They feature a high quality embroidered running horse logo on front mats and a rubber backing with anti-slip spikes. Set includes two front mats and two rear mats.

Year	Desc	Part No.	List
64-73	Black	ACC-FM-EMB-BK	\$119 ⁹⁵ SE
64-68	Aqua	ACC-FM-EMB-AQ	\$119 ⁹⁵ SE
64-68	Bright blue	ACC-FM-EMB-BB	\$119 ⁹⁵ SE
64-73	Dark brown	ACC-FM-EMB-BN	\$169 ⁹⁵ SE
64-73	Bright red	ACC-FM-EMB-BR	\$119 ⁹⁵ SE
64-73	Dark blue	ACC-FM-EMB-DB	\$119 ⁹⁵ SE
64-73	Dark green	ACC-FM-EMB-DG	\$169 ⁹⁵ SE
64-73	Emberglow	ACC-FM-EMB-EM	\$169 ⁹⁵ SE
64-73	Ivy gold	ACC-FM-EMB-IG	\$169 ⁹⁵ SE
64-73	Maroon	ACC-FM-EMB-MR	\$119 ⁹⁵ SE
64-73	Saddle	ACC-FM-EMB-SA	\$169 ⁹⁵ SE

EMBROIDERED, COBRA CARPET FLOOR MATS



64-73: Black, classic Cobra ACC-FM-COBRA-BK

List

\$154⁹⁵ SE



64-73: Black/silver, Tiffany snake ACC-FM-SNAKE-BK

List

\$124⁹⁵ SE

CARPET FLOOR MATS



Aftermarket replacements made by Auto Custom Carpet. Made from the 80/20 blend so this will match 1964-1968 styles. Features rubber backing with anti-slip spikes. All are complete four piece sets, both fronts and two rears.

Year	Description	Part No.	List
64-73	Black, no logo	ACC-FM-BK	\$85 ⁹⁵ SE
64-68	Bright blue, no logo	ACC-FM-BB	\$85 ⁹⁵ SE
64-73	Dark blue, no logo	ACC-FM-DB	\$85 ⁹⁵ SE
64-73	Bright red, no logo	ACC-FM-BR	\$85 ⁹⁵ SE
64-73	Ginger, no logo	ACC-FM-GI	\$85 ⁹⁵ SE
64-73	Ivy gold, no logo	ACC-FM-IG	\$85 ⁹⁵ SE
64-73	Maroon, no logo	ACC-FM-MR	\$85 ⁹⁵ SE
65-68	Turquoise, no logo	ACC-FM-TQ	\$79 ⁹⁵ SE

PONY FLOOR MATS

These are exact copies of an original Ford accessory. Molded in colored PVC these mats also feature spikes on the backside to reduce sliding. Set includes two front and two rear mats.



Year	Description	Part No.	List
64-73	Black, 4 piece set	CSZZ-6513086-BK	\$54 ⁹⁵ SE
64-73	Blue, 4 piece set	CSZZ-6513086-BL	\$59 ⁹⁵ SE
64-73	Brown, 4 piece set	CSZZ-6513086-BN	\$59 ⁹⁵ SE
64-73	Dark red, 4 piece set	CSZZ-6513086-DR	\$59 ⁹⁵ SE
64-73	Red, 4 piece set	CSZZ-6513086-RD	\$59 ⁹⁵ SE

CUSTOM FIT MUSTANG CARPET FLOOR MATS

The same quality as our embroidered floor mats. Features a full-size fit. Available for coupe/fastback and convertible.

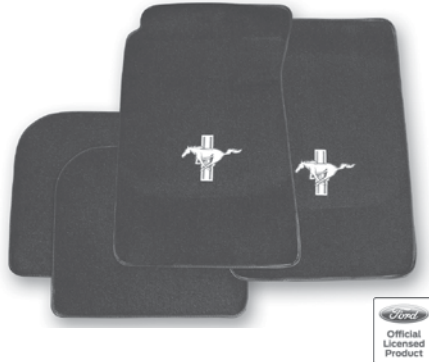

Year	Description	Part No.	List
64-73	Coupe/FB, aqua	ACC-FM-CPFB-AQ	\$149. ⁹⁵ SE
64-73	Coupe/FB, bright blue	ACC-FM-CPFB-BB	\$149. ⁹⁵ SE
64-73	Coupe/FB, black	ACC-FM-CPFB-BK	\$149. ⁹⁵ SE
64-73	Coupe/FB, bright red	ACC-FM-CPFB-BR	\$149. ⁹⁵ SE
64-73	Coupe/FB, dark blue	ACC-FM-CPFB-DB	\$149. ⁹⁵ SE
64-73	Coupe/FB, ember-glow	ACC-FM-CPFB-EM	\$149. ⁹⁵ SE
64-73	Coupe/FB, ginger	ACC-FM-CPFB-GI	\$149. ⁹⁵ SE
64-73	Coupe/FB, green	ACC-FM-CPFB-GR	\$149. ⁹⁵ SE
64-73	Coupe/FB, maroon	ACC-FM-CPFB-MR	\$149. ⁹⁵ SE
64-73	Convertible, aqua	ACC-FM-CV-AQ	\$149. ⁹⁵ SE
64-73	Convertible, bright blue	ACC-FM-CV-BB	\$149. ⁹⁵ SE
64-73	Convertible, black	ACC-FM-CV-BK	\$149. ⁹⁵ SE
64-73	Convertible, bright red	ACC-FM-CV-BR	\$149. ⁹⁵ SE
64-73	Convertible, dark blue	ACC-FM-CV-DB	\$149. ⁹⁵ SE
64-73	Convertible, ivy gold	ACC-FM-CV-IG	\$149. ⁹⁵ SE
64-73	Convertible, maroon	ACC-FM-CV-MR	\$149. ⁹⁵ SE

1964-68 CONCOURS KICK PANELS

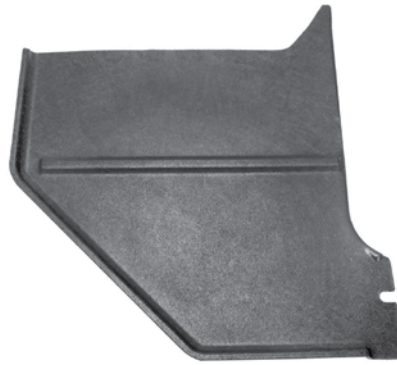

Now made by Drake! These Kick Panels feature Scott Drake's top-of-the-line attention to detail, and are available at a lower price than before! Features include factory hole locations*, correct flared edge to accommodate windlace, and concours correct thickness and texture. Very easy to install compared to economy imports. Use Accu-Match Dyes for other colors. * Note: Factory hole locations for 64-66 version are correct for Late 65-66. Earlier Mustangs had one additional hole.

Year	Description	Part No.	List
64-66	CP/FB, black	C5ZZ-65023445BK	\$38. ⁹⁵ PR
67-68	CP/FB, black	C7ZZ-65023445BK	\$38. ⁹⁵ PR
64-66	CV, black	C5ZZ-76023445BK	\$38. ⁹⁵ PR
67-68	CV, black	C7ZZ-76023445BK	\$38. ⁹⁵ PR
64-66	CP/FB, white	C5ZZ-65023445WT	\$38. ⁹⁵ PR
67-68	CP/FB, parch	C7ZZ-65023445PR	\$38. ⁹⁵ PR
64-66	CV, white	C5ZZ-76023445WT	\$38. ⁹⁵ PR
64-65	CP/FB, med blue	C5ZZ-65023445BL	\$38. ⁹⁵ PR
66	CP/FB, light blue	C6ZZ-65023445LB	\$38. ⁹⁵ PR
66	CP/FB, dark red	C6ZZ-65023445DR	\$38. ⁹⁵ PR
67-68	CP/FB, medium blue	C7ZZ-65023445BL	\$38. ⁹⁵ PR

PONY KICK PANEL CARPET



Made by ACC. Matches the 80/20 blend carpets. Mounts to the lower half of kick panel.

Year	Description	Part No.	List
65-66	CP/FB, dark green	KPC-CP/FB-DG	\$32. ⁹⁵ PR
65-66	CP/FB, bright blue	KPC-CPFB-BB	\$32. ⁹⁵ PR
65-66	CP/FB, black	KPC-CPFB-BK	\$32. ⁹⁵ PR
65-66	CP/FB, dark blue	KPC-CPFB-DB	\$32. ⁹⁵ PR
65-66	CP/FB, emberglow	KPC-CPFB-EM	\$32. ⁹⁵ PR
65-66	CP/FB, ivy gold	KPC-CPFB-IG	\$32. ⁹⁵ PR
65-66	CP/FB, moss green	KPC-CPFB-MG	\$32. ⁹⁵ PR
65-66	CP/FB, maroon	KPC-CPFB-MR	\$32. ⁹⁵ PR
65-66	CP/FB, red	KPC-CPFB-RD	\$32. ⁹⁵ PR

Year	Description	Part No.	List
65-66	CP/FB, saddle	KPC-CPFB-SA	\$32. ⁹⁵ PR
65-66	CP/FB, turquoise	KPC-CPFB-TQ	\$32. ⁹⁵ PR
65-66	CV, bright blue	KPC-CNV-BB	\$32. ⁹⁵ PR
65-66	CV, black	KPC-CNV-BK	\$32. ⁹⁵ PR
65-66	CV, dark blue	KPC-CNV-DB	\$32. ⁹⁵ PR
65-66	CV, dark green	KPC-CNV-DG	\$32. ⁹⁵ PR
65-66	CV, emberglow	KPC-CNV-EM	\$32. ⁹⁵ PR
65-66	CV, ivy gold	KPC-CNV-IG	\$32. ⁹⁵ PR
65-66	CV, maroon	KPC-CNV-MR	\$32. ⁹⁵ PR
65-66	CV, red	KPC-CNV-RD	\$32. ⁹⁵ PR
65-66	CV, saddle	KPC-CNV-SA	\$32. ⁹⁵ PR
65-66	CV, turquoise	KPC-CNV-TQ	\$32. ⁹⁵ PR

KICK PANEL TRIM



Excellent reproductions, made from rust proof 304 stainless steel with a cadmium plated liner. Packaged in pairs.

Year	Part No.	List
65-66	C5ZZ-65023445SS	\$20. ⁰⁰ PR

69-70 KICK PANELS



Exact reproduction. Injection molded black plastic. Very nice.

Year	Description	Part No.	List
69-70	Black	C9ZZ-6502344/5	\$78. ⁹⁵ PR

64-66 KICK PANELS FOR SPEAKERS



The perfect place to install a speaker without doing permanent damage. These new vacuum formed panels feature original style grain and raised platform for speaker installation. Improve sound quality while maintaining factory appearance. Speakers not included. See audio section for kick panel with speakers. Note: Panels can be modified to fit 67-68, requires trimming on top.

Year	Description	Part No.	List
64-66	Coupe/Fastback, black, Also fits 67-68 w/ modifications	C5ZZ-65023445SP	\$79. ⁹⁵ PR
64-66	Convertible, black, Also fits 67-68 w/ modifications	C5ZZ-76023445SP	\$79. ⁹⁵ PR

WE PROUDLY FEATURE AUTHENTIC MUSTANG REPRODUCTIONS FROM SCOTT DRAKE!



145

Interior

AFTERMARKET SEAT BELT



Great looking replacement style seat belts. All feature a mid sixties period look which includes a chrome buckle.

Available in a variety of colors.

Year	Description	Part No.	List
60-73	Aqua	SB-AQ	\$24. ⁹⁵ EA
60-73	Black	SB-BK	\$24. ⁹⁵ SE
64-73	Medium blue	SB-BL	\$24. ⁹⁵ SE
64-73	Bright red	SB-BR	\$24. ⁹⁵ EA
64-73	Dark blue	SB-DB	\$24. ⁹⁵ EA
64-73	Dark red	SB-DR	\$24. ⁹⁵ EA
64-73	Light green	SB-GN	\$24. ⁹⁵ EA
60-73	Light blue	SB-LB	\$24. ⁹⁵ EA
64-73	Maroon	SB-MR	\$24. ⁹⁵ SE
64-73	Parchment/palomino	SB-PR	\$24. ⁹⁵ EA
64-73	Saddle	SB-SA	\$24. ⁹⁵ EA
64-73	White	SB-WT	\$24. ⁹⁵ EA

BLACK WRINKLE SEAT BELT



Exclusively from Scott Drake. We had these seat belts powder coated black with a textured finish to more closely resemble

original style seat belts. Includes mounting hardware.

Year	Description	Part No.	List
64-73	Black wrinkle	SB-BK-DLX	\$32. ⁹⁵ EA



These aftermarket seat belts are sure to turn heads. Replace your old belts with these new ones that feature a pair of brilliantly painted Tri-bar pony emblems. Available in all popular colors. Sold in matching pairs with all hardware included for easy installation.



Year	Description	Part No.	List
64-73	Aqua	SB-AQ-H	\$82. ⁹⁵ SE
64-73	Black	SB-BK-H	\$85. ⁹⁵ SE
64-73	Medium blue	SB-BL-H	\$82. ⁹⁵ SE
64-73	Light blue	SB-LB-H	\$82. ⁹⁵ SE
64-73	Bright red	SB-BR-H	\$82. ⁹⁵ SE
64-73	Dark blue	SB-DB-H	\$82. ⁹⁵ SE
64-73	Dark red	SB-DR-H	\$82. ⁹⁵ SE
64-73	Green	SB-GN-H	\$82. ⁹⁵ SE
64-73	Maroon	SB-MR-H	\$82. ⁹⁵ SE
64-73	Parchment	SB-PR-H	\$82. ⁹⁵ SE
64-73	Saddle	SB-SA-H	\$82. ⁹⁵ SE
64-73	White	SB-WT-H	\$82. ⁹⁵ SE

Interior

PUSH BUTTON SEAT BELT

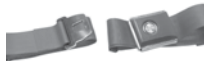

Exclusively from Scott Drake, these are original looking seat belts at

affordable prices. These are not Concours reproductions, but have the correct vintage look used by Ford on several cars in the Mid to Late 1960's. Starburst Medallion used on the buckle is an exact copy of originals. Hardware included!

Year	Description	Part No.	List
64-73	Black	SB-BK-PBSB	\$32. ⁹⁵ EA
64-73	Aqua	SB-AQ-PBSB	\$32. ⁹⁵ EA
64-73	Medium Blue	SB-BL-PBSB	\$32. ⁹⁵ EA
64-73	Bright Red	SB-BR-PBSB	\$32. ⁹⁵ EA
64-73	Dark Blue	SB-DB-PBSB	\$32. ⁹⁵ EA
64-73	Dark Red	SB-DR-PBSB	\$32. ⁹⁵ EA
64-73	Green	SB-GN-PBSB	\$32. ⁹⁵ EA
64-73	Maroon	SB-MR-PBSB	\$32. ⁹⁵ EA
64-73	Parchment	SB-PR-PBSB	\$32. ⁹⁵ EA
64-73	Saddle	SB-SA-PBSB	\$32. ⁹⁵ EA
64-73	White	SB-WT-PBSB	\$32. ⁹⁵ EA
64-73	Light Blue	SB-LB-PBSB	\$32. ⁹⁵ EA

CHROME SEAT BELT BOLT SET



Concours correct for 65-67, but a nice dress-up item for 68-73. This bolt set would compliment any of our seat belts for a more original appearance.

Year	Description	Part No.	List
64-73	Chrome	382627-K	\$29. ⁹⁵ KT

RETRACTABLE SEAT BELT

Great looking replacement style seat belts. All feature a mid sixties period look which includes a chrome lift buckle or push button buckle. **Look for concours correct 68-69 version in early 2016 under part # SB-BK-68-CR**



64-73: Black, low profile retractor, *Will not fit 64-67 convertibles
SB-BK-65

List
\$52. ⁹⁵ EA



64-73: Black, low profile retractor, *Will not fit 64-67 convertibles
SB-BK-65-PBSB

List
\$64. ⁹⁵ EA



68-73 Coupe/Fastback: Black *will fit 64-67 but not recommended for taller drivers that must slide seat all the way back
SB-BK-68

List
\$54. ⁹⁵ EA



68-73 Coupe/Fastback: Black *will fit 64-67 but not recommended for taller drivers that must slide seat all the way back
SB-BK-68-PBSB

List
\$65. ⁹⁵ EA

SEAT BELT RETRACTOR



A great way to "tidy up" your interior as well as make your seat belts easier to use. Just pre-wind these retractors and

insert the belt into the notches, let go and the belt will roll up and stay in easy reach. Exact copy of Ford accessory.

Year	Description	Part No.	List
64-67	USA, concours	C4AZ-65611A06	\$29. ⁹⁵ EA
64-67	Imported, reproduction	C4AZ-65611A06-R	\$24. ⁹⁵ PR

3 INCH RACE STYLE LAP BELT



Get that Cool Vintage Race Car look that was used in many competition cars during the 1960's including 1965-66 Shelby's. Extra

wide 3" belt with quick release latch and a genuine Leather Protective Pad adds some extra safety over stock lap belts. Mounting Hardware included.

Year	Description	Part No.	List
64-73	Black	SB-RACE	\$66. ⁹⁵ EA

Ask your Dealer or check out our Website for 68-69 Concours correct Seat Belts that will be available early 2016 under the following part numbers:

SB-3P-BK-68-C

68-69 Concours Retractable Lap Belt with Shoulder Belt \$174.95 Each

SB-BK-68-CR

68-69 Concours Retractable Lap Belt \$124.95 Each

SB-BK-68-C

68-69 Concours Non-Retractable Lap Belt \$49.95 Each

RETRACTABLE 3-POINT SEAT BELT



This product allows you to convert your 1964-67 Mustang Coupe, Fastback or Convertible's seat belts to a safer, modern 3-Point design. This is today's technology for yesterday's classic car. This Seat Belt Kit comes complete with all the hardware needed along with instructions to guide you through the installation. Available in a variety of colors. This Kit will also work on 68-73 Mustangs, but if you use existing roof mounting point, the webbing may be too short for some Drivers. For 1968-73 customers looking for a more original appearance and wishing to use their factory Roof mounting point we offer SB-3P-BK-PBSB in Black only. All of the Seat Belts are made in the USA and are built under the current Governments safety guidelines. **1 kit does both seats.**

Year	Desc	Part No.	List
64-73	Black	SB-3P-BK	\$199. ⁹⁵ KT
64-73	Blue	SB-3P-BL	\$199. ⁹⁵ KT
64-73	Light Blue	SB-3P-LB	\$199. ⁹⁵ KT
64-73	Bright Red	SB-3P-BR	\$199. ⁹⁵ KT
64-73	Green	SB-3P-GN	\$199. ⁹⁵ KT
64-73	Parchment	SB-3P-PR	\$199. ⁹⁵ KT
64-73	White	SB-3P-WT	\$199. ⁹⁵ KT

PUSH BUTTON 3 POINT SEAT BELT



These 3 Point Seat Belts will bolt onto any 1968-73 Coupe or Fastback using your existing mounting points. For all customers with 1964-67 Coupes or 1968-73 Convertibles wishing to add 3 point Seat Belts to your car you will need to buy two Hardware Mounting Kits, part # SB-3P-HK. The belt buckles are very similar to the original buckles Ford used in the late 1960's and early 1970's and even feature an exact copy of the Starburst emblem. **NO MOUNTING HARDWARE INCLUDED.**

Part No.	Year	Description	List
SB-3P-BK-PBSB	64-73	Black, push button style buckle	\$199. ⁹⁵ KT

SEAT BELT BUCKLE BUTTON COVER



Year	Part No.	List
68-70	C8AZ-65611C02-A	\$5. ⁹⁵ PR

3 POINT SEAT BELT HARDWARE



Mounting hardware is Grade 5 hardness to ensure maximum safety. This mounting kit is specifically designed for Mustangs.

Not a universal kit. Includes instructions. 2 required per car. **This is included in all Retractable 3-Point Seat Belt kits above except SB-3P-BK-PBSB.**

Year	Description	Part No.	List
64-73	3 Point	SB-3P-HK	\$12. ⁹⁵ EA

SEAT BELT BUCKLE BEZEL



Replace those worn buckle bezels with our new chromed bezels. They just snap on. Brings life back to those old seat belts.

Year	Description	Part No.	List
68-70	Chrome	C8AZ-65611A72-A	\$29. ⁹⁵ PR
68-70	Black	C8AZ-65611A72-B	\$19. ⁹⁵ PR

SEAT BELT BUCKLE TOPS



Year	Part No.	List
68-70	C8AZ-65611A72-T	\$14. ⁹⁵ PR

DELUXE SEAT BELT BUCKLE RESTORATION KIT



Now you can restore your 1968-70 Mustang's interior back to its original showroom condition

by replacing cracked, broken, or missing seat belt buckle components with Scott Drake's new Deluxe Seat Belt Buckle Restoration Kit. Tooled to the original factory specifications from OEM quality injected molded black plastic. This seat belt buckle kit features the correct texture grain pattern top plate, polished chrome bezels, and starburst medallions for a perfect restoration. The release button and spring are included. One kit does a pair of belts.

Year	Part No.	List
68-70	Chrome bezel	\$54. ⁹⁵ KI
68-70	Black bezel	\$44. ⁹⁵ KI

SEAT BELT BUCKLE RESTORATION KIT



Perfect reproductions of commonly worn parts. Now bring those old seat belt buckles back with

our chrome bezels & highly detailed release button covers. One kit does a pair of belts.

Year	Desc	Part No.	List
68-70	Chrome	C8AZ-65611A72-K	\$34. ⁹⁵ KT
68-70	Black	C8AZ-65611A72BK	\$44. ⁹⁵ KT

ROLL BAR



It is attractively finished in a black textured powder coated surface. Installation requires welding at floor mounts. This roll bar will

fit 65-66 Fastbacks with minor modification to floor mounts. Roof mount brackets and seat belt brackets are included. Must be shipped truck freight. We can drop ship from Midwest manufacturer for East Coast customers. Similar to 67-68 Shelby.

Year	Part No.	List
65-68 Fastback	S7MS-RB	\$449. ⁰⁰ EA

STANDARD SEAT UPHOLSTERY - FULL SET



These are complete seat upholstery sets for Mustangs with standard bucket seats.

Ours are the best on the market, precision made from the same heavy duty vinyl and attention to detail originally used by Ford. Our custom colors are an exact match. Heavy 32 ounce vinyl and solid welt cord. Patterns are die cut for precision. In the case of Pony patterns, they have the same detail as the originals. Kits do not include hog rings for installation. Deluxe interior seat button sold separately for 67-68 deluxe interior.



Year	Description	Part No.	List
64-65	CP, black	65CP-S-FULL-BKT	\$224. ⁹⁵ SE
64-65	CP, blue	65CP-S-FULL-BL	\$212. ⁹⁵ SE
64-65	CP, bright red	65CP-S-FULL-BR	\$212. ⁹⁵ SE
64-65	CP, ivy gold	65CP-S-FULL-IG	\$212. ⁹⁵ SE
64-65	CP, white	65CP-S-FULL-WT	\$212. ⁵⁰ SE
64-65	CV, black	65CV-S-FULL-BK	\$212. ⁵⁰ SE
64-65	CV, blue	65CV-S-FULL-BL	\$212. ⁵⁰ SE
64-65	CV, bright red	65CV-S-FULL-BR	\$212. ⁵⁰ SE
64-65	CV, ivy gold	65CV-S-FULL-IG	\$212. ⁵⁰ SE
64-65	CV, palomino	65CV-S-FULL-PA	\$212. ⁵⁰ SE
64-65	CV, white	65CV-S-FULL-WT	\$212. ⁵⁰ SE
65	FB, black	65FB-S-FULL-BK	\$212. ⁵⁰ SE
65	FB, blue	65FB-S-FULL-BL	\$212. ⁵⁰ SE

Interior

WE PROUDLY FEATURE AUTHENTIC MUSTANG REPRODUCTIONS FROM SCOTT DRAKE!



Year	Description	Part No.	List
65	FB, bright red	65FB-S-FULL-BR	\$212. ⁵⁰ SE
65	FB, ivy gold	65FB-S-FULL-IG	\$212. ⁵⁰ SE
65	FB, palomino	65FB-S-FULL-PA	\$212. ⁵⁰ SE
65	FB, white	65FB-S-FULL-WT	\$212. ⁵⁰ SE
66	CP, aqua	66CP-S-FULL-AQ	\$212. ⁵⁰ SE
66	CP, black	66CP-S-FULL-BK	\$212. ⁵⁰ SE
66	CP, blue	66CP-S-FULL-BL	\$212. ⁵⁰ SE
66	CP, dark red	66CP-S-FULL-DR	\$212. ⁵⁰ SE
66	CP, parchment	66CP-S-FULL-PR	\$212. ⁵⁰ SE
66	CV, aqua	66CV-S-FULL-AQ	\$212. ⁵⁰ SE
66	CV, black	66CV-S-FULL-BK	\$212. ⁵⁰ SE
66	CV, blue	66CV-S-FULL-BL	\$212. ⁵⁰ SE
66	CV, dark red	66CV-S-FULL-DR	\$212. ⁵⁰ SE
66	CV, parchment	66CV-S-FULL-PR	\$212. ⁵⁰ SE
66	FB, aqua	66FB-S-FULL-AQ	\$212. ⁵⁰ SE
66	FB, black	66FB-S-FULL-BK	\$212. ⁵⁰ SE
66	FB, blue	66FB-S-FULL-BL	\$212. ⁵⁰ SE
66	FB, dark red	66FB-S-FULL-DR	\$212. ⁵⁰ SE
66	FB, parchment	66FB-S-FULL-PR	\$212. ⁵⁰ SE
67	CP, aqua	67CP-S-FULL-AQ	\$212. ⁵⁰ SE
67	CP, black	67CP-S-FULL-BK	\$212. ⁵⁰ SE
67	CP, blue	67CP-S-FULL-BL	\$212. ⁵⁰ SE
67	CP, dark red	67CP-S-FULL-DR	\$212. ⁵⁰ SE
67	CP, ivy gold	67CP-S-FULL-IG	\$212. ⁵⁰ SE
67	CP, parchment	67CP-S-FULL-PR	\$212. ⁵⁰ SE
67	CP, saddle	67CP-S-FULL-SA	\$212. ⁵⁰ SE
67	CV, aqua	67CV-S-FULL-AQ	\$212. ⁵⁰ SE
67	CV, black	67CV-S-FULL-BK	\$212. ⁵⁰ SE
67	CV, blue	67CV-S-FULL-BL	\$212. ⁵⁰ SE
67	CV, dark red	67CV-S-FULL-DR	\$212. ⁵⁰ SE
67	CV, ivy gold	67CV-S-FULL-IG	\$212. ⁵⁰ SE
67	CV, parchment	67CV-S-FULL-PR	\$212. ⁵⁰ SE
67	CV, saddle	67CV-S-FULL-SA	\$212. ⁵⁰ SE
67	FB, aqua	67FB-S-FULL-AQ	\$212. ⁵⁰ SE
67	FB, black	67FB-S-FULL-BK	\$212. ⁵⁰ SE
67	FB, blue	67FB-S-FULL-BL	\$212. ⁵⁰ SE
67	FB, dark red	67FB-S-FULL-DR	\$212. ⁵⁰ SE
67	FB, ivy gold	67FB-S-FULL-IG	\$212. ⁵⁰ SE
67	FB, parchment	67FB-S-FULL-PR	\$212. ⁵⁰ SE
67	FB, saddle	67FB-S-FULL-SA	\$212. ⁵⁰ SE
68	CP, aqua	68CP-S-FULL-AQ	\$212. ⁵⁰ SE
68	CP, black	68CP-S-FULL-BK	\$212. ⁵⁰ SE
68	CP, blue	68CP-S-FULL-BL	\$212. ⁵⁰ SE
68	CP, ivy gold	68CP-S-FULL-IG	\$212. ⁵⁰ SE
68	CP, maroon	68CP-S-FULL-MR	\$212. ⁵⁰ SE
68	CP, nugget gold	68CP-S-FULL-NG	\$212. ⁵⁰ SE
68	CP, parchment	68CP-S-FULL-PR	\$212. ⁵⁰ SE
68	CP, red/white	68CP-S-FULL-R/W	\$212. ⁵⁰ SE
68	CP, saddle	68CP-S-FULL-SA	\$212. ⁵⁰ SE
68	CV, aqua	68CV-S-FULL-AQ	\$212. ⁵⁰ SE
68	CV, black	68CV-S-FULL-BK	\$212. ⁵⁰ SE
68	CV, blue	68CV-S-FULL-BL	\$212. ⁵⁰ SE
68	CV, ivy gold	68CV-S-FULL-IG	\$212. ⁵⁰ SE
68	CV, maroon	68CV-S-FULL-MR	\$212. ⁵⁰ SE
68	CV, nugget gold	68CV-S-FULL-NG	\$212. ⁵⁰ SE
68	CV, parchment	68CV-S-FULL-PR	\$212. ⁵⁰ SE
68	CV, saddle	68CV-S-FULL-SA	\$212. ⁵⁰ SE
68	FB, aqua	68FB-S-FULL-AQ	\$212. ⁵⁰ SE

Year	Description	Part No.	List
68	FB, black	68FB-S-FULL-BK	\$212. ⁵⁰ SE
68	FB, blue	68FB-S-FULL-BL	\$212. ⁵⁰ SE
68	FB, ivy gold	68FB-S-FULL-IG	\$212. ⁵⁰ SE
68	FB, maroon	68FB-S-FULL-MR	\$212. ⁵⁰ SE
68	FB, nugget gold	68FB-S-FULL-NG	\$212. ⁵⁰ SE
68	FB, parchment	68FB-S-FULL-PR	\$212. ⁵⁰ SE
68	FB, saddle	68FB-S-FULL-SA	\$212. ⁵⁰ SE
69	CP, black	69CP-S-FULL-BK	\$212. ⁵⁰ SE
69	CP, dark red	69CP-S-FULL-DR	\$212. ⁵⁰ SE
69	CP, ivy gold	69CP-S-FULL-IG	\$212. ⁵⁰ SE
69	CP, light blue	69CP-S-FULL-LB	\$212. ⁵⁰ SE
69	CP, nugget gold	69CP-S-FULL-NG	\$212. ⁵⁰ SE
69	CP, white	69CP-S-FULL-WT	\$212. ⁵⁰ SE
69	CV, black	69CV-S-FULL-BK	\$212. ⁵⁰ SE
69	CV, dark red	69CV-S-FULL-DR	\$212. ⁵⁰ SE
69	CV, ivy gold	69CV-S-FULL-IG	\$212. ⁵⁰ SE
69	CV, light blue	69CV-S-FULL-LB	\$212. ⁵⁰ SE
69	CV, nugget gold	69CV-S-FULL-NG	\$212. ⁵⁰ SE
69	CV, white	69CV-S-FULL-WT	\$212. ⁵⁰ SE
69	FB, black	69FB-S-FULL-BK	\$212. ⁵⁰ SE
69	FB, dark red	69FB-S-FULL-DR	\$212. ⁵⁰ SE
69	FB, ivy gold	69FB-S-FULL-IG	\$212. ⁵⁰ SE
69	FB, light blue	69FB-S-FULL-LB	\$212. ⁵⁰ SE
69	FB, nugget gold	69FB-S-FULL-NG	\$212. ⁵⁰ SE
70	CP, black	70CP-S-FULL-BK	\$279. ⁹⁵ SE
70	CP, blue	70CP-S-FULL-BL	\$279. ⁹⁵ SE
70	CP, ginger	70CP-S-FULL-GI	\$279. ⁹⁵ SE
70	CP, ivy gold	70CP-S-FULL-IV	\$279. ⁹⁵ SE
70	CP, vermillion	70CP-S-FULL-VE	\$279. ⁹⁵ SE
70	CP, white	70CP-S-FULL-WT	\$279. ⁹⁵ SE
70	CV, black	70CV-S-FULL-BK	\$279. ⁹⁵ SE
70	CV, blue	70CV-S-FULL-BL	\$279. ⁹⁵ SE
70	CV, ginger	70CV-S-FULL-GI	\$279. ⁹⁵ SE
70	CV, ivy gold	70CV-S-FULL-IV	\$279. ⁹⁵ SE
70	CV, vermillion	70CV-S-FULL-VE	\$279. ⁹⁵ SE
70	CV, white	70CV-S-FULL-WT	\$279. ⁹⁵ SE
70	FB, black	70FB-S-FULL-BK	\$279. ⁹⁵ SE
70	FB, blue	70FB-S-FULL-BL	\$279. ⁹⁵ SE
70	FB, ginger	70FB-S-FULL-GI	\$279. ⁹⁵ SE
70	FB, ivy gold	70FB-S-FULL-IV	\$279. ⁹⁵ SE
70	FB, vermillion	70FB-S-FULL-VE	\$279. ⁹⁵ SE
70	FB, white	70FB-S-FULL-WT	\$279. ⁹⁵ SE
71-73	CP, black	71CP-S-FULL-BK	\$279. ⁹⁵ SE
71-73	CP, blue	71CP-S-FULL-BL	\$279. ⁹⁵ SE
71-73	CP, ginger	71CP-S-FULL-GI	\$279. ⁹⁵ SE
71-73	CP, green	71CP-S-FULL-GR	\$279. ⁹⁵ SE
71	CP, vermillion	71CP-S-FULL-VE	\$279. ⁹⁵ SE
71-73	CP, white	71CP-S-FULL-WT	\$279. ⁹⁵ SE
71	CV, black	71CV-S-FULL-BK	\$279. ⁹⁵ SE
71	CV, blue	71CV-S-FULL-BL	\$279. ⁹⁵ SE
71	CV, ginger	71CV-S-FULL-GI	\$279. ⁹⁵ SE
71	CV, green	71CV-S-FULL-GR	\$279. ⁹⁵ SE
71	CV, vermillion	71CV-S-FULL-VE	\$279. ⁹⁵ SE
71	CV, white	71CV-S-FULL-WT	\$279. ⁹⁵ SE
71-73	FB, black	71FB-S-FULL-BK	\$279. ⁹⁵ SE
71-73	FB, blue	71FB-S-FULL-BL	\$279. ⁹⁵ SE
71-73	FB, ginger	71FB-S-FULL-GI	\$279. ⁹⁵ SE
71-73	FB, green	71FB-S-FULL-GR	\$279. ⁹⁵ SE

Year	Description	Part No.	List
71-73	FB, vermillion	71FB-S-FULL-VE	\$279. ⁹⁵ SE
71-73	FB, white	71FB-S-FULL-WT	\$279. ⁹⁵ SE

STANDARD SEAT UPHOLSTERY - FRONT ONLY



These are front only seat upholstery sets for Mustangs with standard bucket seats. Ours are the best on the market,

precision made from the same heavy duty vinyl and attention to detail originally used by Ford. Our custom colors are an exact match. Heavy 32 ounce vinyl and solid welt cord. Patterns are die cut for precision. In the case of Pony patterns, they have the same detail as the originals. Kits do not include hog rings for installation. Deluxe interior seat button sold separately for 67-68 deluxe interior.



Year	Description	Part No.	List
64-65	Black	65-S-BUCK-BK	\$150. ⁹⁵ PR
64-65	Blue	65-S-BUCK-BL	\$150. ⁹⁵ PR
64-65	Bright red	65-S-BUCK-BR	\$150. ⁹⁵ PR
64-65	Ivy gold	65-S-BUCK-IG	\$150. ⁹⁵ PR
64-65	Palomino	65-S-BUCK-PA	\$150. ⁹⁵ PR
64-65	White	65-S-BUCK-WT	\$150. ⁹⁵ PR
66	Aqua	66-S-BUCK-AQ	\$150. ⁹⁵ PR
66	Black	66-S-BUCK-BK	\$150. ⁹⁵ PR
66	Blue	66-S-BUCK-BL	\$150. ⁹⁵ PR
66	Dark red	66-S-BUCK-DR	\$150. ⁹⁵ PR
66	Parchment	66-S-BUCK-PR	\$150. ⁹⁵ PR
67	Aqua	67-S-BUCK-AQ	\$150. ⁹⁵ PR
67	Black	67-S-BUCK-BK	\$150. ⁹⁵ PR
67	Blue	67-S-BUCK-BL	\$150. ⁹⁵ PR
67	Dark red	67-S-BUCK-DR	\$150. ⁹⁵ PR
67	Ivy gold	67-S-BUCK-IG	\$150. ⁹⁵ PR
67	Parchment	67-S-BUCK-PR	\$150. ⁹⁵ PR
67	Saddle	67-S-BUCK-SA	\$150. ⁹⁵ PR
68	Aqua	68-S-BUCK-AQ	\$150. ⁹⁵ PR
68	Black	68-S-BUCK-BK	\$150. ⁹⁵ PR
68	Blue	68-S-BUCK-BL	\$150. ⁹⁵ PR
68	Ivy gold	68-S-BUCK-IG	\$150. ⁹⁵ PR
68	Maroon	68-S-BUCK-MR	\$150. ⁹⁵ PR
68	Nugget gold	68-S-BUCK-NG	\$150. ⁹⁵ PR
68	Parchment	68-S-BUCK-PR	\$150. ⁹⁵ PR
68	Saddle	68-S-BUCK-SA	\$150. ⁹⁵ PR
69	Black	69-S-BUCK-BK	\$150. ⁹⁵ PR
69	Dark red	69-S-BUCK-DR	\$150. ⁹⁵ PR
69	Ivy gold	69-S-BUCK-IG	\$150. ⁹⁵ PR
69	Light blue	69-S-BUCK-LB	\$150. ⁹⁵ PR
69	Nugget gold	69-S-BUCK-NG	\$150. ⁹⁵ PR
70	Black	70-S-BUCK-BK	\$194. ⁹⁵ PR
70	Blue	70-S-BUCK-BL	\$194. ⁹⁵ PR
70	Ginger	70-S-BUCK-GI	\$194. ⁹⁵ PR
70	Green	70-S-BUCK-GR	\$194. ⁹⁵ PR

Year	Description	Part No.	List
70	Ivy gold	70-S-BUCK-IV	\$194 ⁹⁵ PR
70	Vermillion	70-S-BUCK-VE	\$194 ⁹⁵ PR
70	White	70-S-BUCK-WT	\$194 ⁹⁵ PR
71-73	Black	71-S-BUCK-BK	\$194 ⁹⁵ PR
71-73	Blue	71-S-BUCK-BL	\$194 ⁹⁵ PR
71-73	Ginger	71-S-BUCK-GI	\$194 ⁹⁵ PR
71-73	Green	71-S-BUCK-GR	\$194 ⁹⁵ PR
71-73	Vermillion	71-S-BUCK-VE	\$194 ⁹⁵ PR
71-73	White	71-S-BUCK-WT	\$194 ⁹⁵ PR

pony SEAT UPHOLSTERY - FULL SET



These are complete seat upholstery sets for 64-66 Mustangs with Pony Interiors. Ours are the best on the market, precision

made from the same heavy duty vinyl and attention to detail originally used by Ford. Our custom colors are an exact match. Heavy 32 ounce vinyl and solid welt cord. Patterns are die cut for precision. In the case of Pony patterns, they have the same detail as the originals. Kits do not include hog rings for installation.



Year	Description	Part No.	List
65	CP, black/white	65CP-P-FULL-B/W	\$299 ⁹⁵ SE
65	CP, black	65CP-P-FULL-BK	\$299 ⁹⁵ SE
65	CP, blue/white	65CP-P-FULL-BL	\$299 ⁹⁵ SE
65	CP, bright red	65CP-P-FULL-BR	\$299 ⁹⁵ SE
65	CP, ivy gold/white	65CP-P-FULL-IG	\$299 ⁹⁵ SE
65	CP, palomino	65CP-P-FULL-PA	\$299 ⁹⁵ SE
65	CP, red/white	65CP-P-FULL-R/W	\$299 ⁹⁵ SE
65	CP, white	65CP-P-FULL-WT	\$299 ⁹⁵ SE
65-66	CV, black/white	65CV-P-FULL-B/W	\$299 ⁹⁵ SE
65-66	CV, black	65CV-P-FULL-BK	\$299 ⁹⁵ SE
65-66	CV, blue/white	65CV-P-FULL-BL	\$299 ⁹⁵ SE
65	CV, bright red	65CV-P-FULL-BR	\$299 ⁹⁵ SE
65-66	CV, ivy gold/white	65CV-P-FULL-IG	\$299 ⁹⁵ SE
65	CV, palomino	65CV-P-FULL-PA	\$299 ⁹⁵ SE
65	CV, bright red/white	65CV-P-FULL-R/W	\$299 ⁹⁵ SE
65	CV, white	65CV-P-FULL-WT	\$299 ⁹⁵ SE
65-66	FB, black/white	65FB-P-FULL-B/W	\$299 ⁹⁵ SE
65-66	FB, black	65FB-P-FULL-BK	\$299 ⁹⁵ SE
65-66	FB, blue/white	65FB-P-FULL-BL	\$299 ⁹⁵ SE
65	FB, red	65FB-P-FULL-BR	\$299 ⁹⁵ SE
65-66	FB, ivy gold/white	65FB-P-FULL-IG	\$299 ⁹⁵ SE
65	FB, palomino	65FB-P-FULL-PA	\$299 ⁹⁵ SE
65	FB, red/white	65FB-P-FULL-R/W	\$299 ⁹⁵ SE
65	FB, white	65FB-P-FULL-WT	\$299 ⁹⁵ SE
66	CP, aqua/white	66CP-P-FULL-AQ	\$299 ⁹⁵ SE
66	CP, dark red	66CP-P-FULL-DR	\$299 ⁹⁵ SE
66	CP, emberblo/parchment	66CP-P-FULL-EM	\$299 ⁹⁵ SE

Year	Description	Part No.	List
66	CP, parchment	66CP-P-FULL-PR	\$299 ⁹⁵ SE
66	CP, dark red/white	66CP-P-FULL-R/W	\$299 ⁹⁵ SE
66	CV, aqua/white	66CV-P-FULL-AQ	\$299 ⁹⁵ SE
66	CV, dark red	66CV-P-FULL-DR	\$299 ⁹⁵ SE
66	CV, emberblo/parchment	66CV-P-FULL-EM	\$299 ⁹⁵ SE
66	CV, parchment	66CV-P-FULL-PR	\$299 ⁹⁵ SE
66	CV, dark red/white	66CV-P-FULL-R/W	\$299 ⁹⁵ SE
66	FB, aqua/white	66FB-P-FULL-AQ	\$299 ⁹⁵ SE
66	FB, dark red	66FB-P-FULL-DR	\$299 ⁹⁵ SE
66	FB, emberblo/parchment	66FB-P-FULL-EM	\$299 ⁹⁵ SE
66	FB, parchment	66FB-P-FULL-PR	\$299 ⁹⁵ SE
66	FB, dark red/white	66FB-P-FULL-R/W	\$299 ⁹⁵ SE

pony SEAT UPHOLSTERY - FRONT ONLY

Year	Description	Part No.	List
65	Black	65-P-BUCK-BK	\$219 ⁹⁵ SE
65	Blue/white	65-P-BUCK-BL	\$219 ⁹⁵ SE
65	Bright red	65-P-BUCK-BR	\$219 ⁹⁵ SE
65	Ivy gold/white	65-P-BUCK-IG	\$219 ⁹⁵ SE
65	Palomino	65-P-BUCK-PA	\$219 ⁹⁵ SE
65	White	65-P-BUCK-WT	\$219 ⁹⁵ SE
66	Aqua/white	66-P-BUCK-AQ	\$219 ⁹⁵ SE
66	Dark red	66-P-BUCK-DR	\$219 ⁹⁵ SE
66	Emberblo/parchment	66-P-BUCK-EM	\$219 ⁹⁵ SE
66	Parchment	66-P-BUCK-PR	\$219 ⁹⁵ SE



For TMI Door Panels see page 168

BENCH SEAT UPHOLSTERY - FULL SET



These are complete seat upholstery sets for Mustangs with a bench seat. Ours are the best on the market, precision made

from the same heavy duty vinyl and attention to detail originally used by Ford. Our custom colors are an exact match. Heavy 32 ounce vinyl and solid welt cord. Patterns are die cut for precision. In the case of Pony patterns, they have the same detail as the originals. Kits do not include hog rings for installation.

Year	Description	Part No.	List
65	CP, black	65CP-B-FULL-BK	\$274 ⁹⁵ SE
65	CP, blue	65CP-B-FULL-BL	\$274 ⁹⁵ SE
65	CP, bright red	65CP-B-FULL-BR	\$274 ⁹⁵ SE
65	CP, ivy gold	65CP-B-FULL-IG	\$274 ⁹⁵ SE
65	CP, palomino	65CP-B-FULL-PA	\$274 ⁹⁵ SE
65	CP, white	65CP-B-FULL-WT	\$274 ⁹⁵ SE
65	CV, black	65CV-B-FULL-BK	\$274 ⁹⁵ SE
65	CV, blue	65CV-B-FULL-BL	\$274 ⁹⁵ SE
65	CV, bright red	65CV-B-FULL-BR	\$274 ⁹⁵ SE
65	CV, ivy gold	65CV-B-FULL-IG	\$274 ⁹⁵ SE
65	CV, palomino	65CV-B-FULL-PA	\$274 ⁹⁵ SE
65	CV, white	65CV-B-FULL-WT	\$274 ⁹⁵ SE

66	CP, aqua	66CP-B-FULL-AQ	\$274 ⁹⁵ SE
66	CP, black	66CP-B-FULL-BK	\$274 ⁹⁵ SE
66	CP, blue	66CP-B-FULL-BL	\$274 ⁹⁵ SE
66	CP, dark red	66CP-B-FULL-DR	\$274 ⁹⁵ SE
66	CP, parchment	66CP-B-FULL-PR	\$274 ⁹⁵ SE
66	CV, aqua	66CV-B-FULL-AQ	\$274 ⁹⁵ SE
66	CV, black	66CV-B-FULL-BK	\$274 ⁹⁵ SE
66	CV, blue	66CV-B-FULL-BL	\$274 ⁹⁵ SE
66	CV, dark red	66CV-B-FULL-DR	\$274 ⁹⁵ SE
66	CV, parchment	66CV-B-FULL-PR	\$274 ⁹⁵ SE

67	CP, aqua	67CP-B-FULL-AQ	\$274 ⁹⁵ SE
67	CP, black	67CP-B-FULL-BK	\$274 ⁹⁵ SE
67	CP, blue	67CP-B-FULL-BL	\$274 ⁹⁵ SE
67	CP, dark red	67CP-B-FULL-DR	\$274 ⁹⁵ SE
67	CP, ivy gold	67CP-B-FULL-IG	\$274 ⁹⁵ SE
67	CP, parchment	67CP-B-FULL-PR	\$274 ⁹⁵ SE
67	CP, saddle	67CP-B-FULL-SA	\$274 ⁹⁵ SE
67	CV, aqua	67CV-B-FULL-AQ	\$274 ⁹⁵ SE
67	CV, black	67CV-B-FULL-BK	\$274 ⁹⁵ SE
67	CV, blue	67CV-B-FULL-BL	\$274 ⁹⁵ SE
67	CV, dark red	67CV-B-FULL-DR	\$274 ⁹⁵ SE
67	CV, ivy gold	67CV-B-FULL-IG	\$274 ⁹⁵ SE
67	CV, parchment	67CV-B-FULL-PR	\$274 ⁹⁵ SE
67	CV, saddle	67CV-B-FULL-SA	\$274 ⁹⁵ SE
68	CP, aqua	68CP-B-FULL-AQ	\$274 ⁹⁵ SE
68	CP, black	68CP-B-FULL-BK	\$274 ⁹⁵ SE
68	CP, blue	68CP-B-FULL-BL	\$274 ⁹⁵ SE
68	CP, ivy gold	68CP-B-FULL-IG	\$274 ⁹⁵ SE

Interior

WE PROUDLY FEATURE AUTHENTIC MUSTANG REPRODUCTIONS FROM SCOTT DRAKE!



Year	Description	Part No.	
68	CP, maroon	68CP-B-FULL-MR	\$274. ⁹⁵ SE
68	CP, nug gold	68CP-B-FULL-NG	\$274. ⁹⁵ SE
68	CP, parchment	68CP-B-FULL-PR	\$274. ⁹⁵ SE
68	CP, saddle	68CP-B-FULL-SA	\$274. ⁹⁵ SE
68	FB, aqua	68FB-B-FULL-AQ	\$274. ⁹⁵ SE
68	FB, black	68FB-B-FULL-BK	\$274. ⁹⁵ SE
68	FB, blue	68FB-B-FULL-BL	\$274. ⁹⁵ SE
68	FB, ivy gold	68FB-B-FULL-IG	\$274. ⁹⁵ SE
68	FB, maroon	68FB-B-FULL-MR	\$274. ⁹⁵ SE
68	FB, nug gold	68FB-B-FULL-NG	\$274. ⁹⁵ SE
68	FB, parchment	68FB-B-FULL-PR	\$274. ⁹⁵ SE
68	FB, saddle	68FB-B-FULL-SA	\$274. ⁹⁵ SE
69	CP, black	69CP-B-FULL-BK	\$274. ⁹⁵ SE
69	CP, dark red	69CP-B-FULL-DR	\$274. ⁹⁵ SE
69	CP, ivy gold	69CP-B-FULL-IG	\$274. ⁹⁵ SE
69	CP, light blue	69CP-B-FULL-LB	\$274. ⁹⁵ SE
69	CP, nug gold	69CP-B-FULL-NG	\$274. ⁹⁵ SE

1965-69 BENCH SEAT UPHOLSTERY - FULL SET

Year	Description	Part No.	List
65	Black	65-B-BENCH-BK	\$189. ⁹⁵ SE
65	Blue	65-B-BENCH-BL	\$189. ⁹⁵ SE
65	Bright red	65-B-BENCH-BR	\$189. ⁹⁵ SE
65	Ivy gold	65-B-BENCH-IG	\$189. ⁹⁵ SE
65	Palomino	65-B-BENCH-PA	\$189. ⁹⁵ SE
65	White	65-B-BENCH-WT	\$189. ⁹⁵ SE

66	Aqua	66-B-BENCH-AQ	\$189. ⁹⁵ SE
66	Black	66-B-BENCH-BK	\$189. ⁹⁵ SE
66	Blue	66-B-BENCH-BL	\$189. ⁹⁵ SE
66	Dark red	66-B-BENCH-DR	\$189. ⁹⁵ SE
66	Parchment	66-B-BENCH-PR	\$189. ⁹⁵ SE

67	Aqua	67-B-BENCH-AQ	\$189. ⁹⁵ SE
67	Black	67-B-BENCH-BK	\$189. ⁹⁵ SE
67	Blue	67-B-BENCH-BL	\$189. ⁹⁵ SE
67	Dark red	67-B-BENCH-DR	\$189. ⁹⁵ SE
67	Ivy gold	67-B-BENCH-IG	\$189. ⁹⁵ SE
67	Parchment	67-B-BENCH-PR	\$189. ⁹⁵ SE
67	Saddle	67-B-BENCH-SA	\$189. ⁹⁵ SE

68	Aqua	68-B-BENCH-AQ	\$189. ⁹⁵ SE
68	Black	68-B-BENCH-BK	\$189. ⁹⁵ SE
68	Blue	68-B-BENCH-BL	\$189. ⁹⁵ SE
68	Ivy gold	68-B-BENCH-IG	\$189. ⁹⁵ SE
68	Maroon	68-B-BENCH-MR	\$189. ⁹⁵ SE
68	Nugget gold	68-B-BENCH-NG	\$189. ⁹⁵ SE
68	Parchment	68-B-BENCH-PR	\$189. ⁹⁵ SE
68	Saddle	68-B-BENCH-SA	\$189. ⁹⁵ SE
68	Turquoise	68-B-BENCH-TQ	\$189. ⁹⁵ SE

NON-ADJUSTABLE HEAD REST



These head rests makes retrofitting original Mustang seat to head rest types possible. Kit includes color keyed head rest, mounting

brackets, hardware and instructions. For adjustable head rest please turn to the TMI pages at the end of the Interior Section.

Year	Description	Part No.	List
64-67	Standard, black	HR-BK-S	\$199. ⁹⁵ KT

1967 TILTING HEAD RESTS



5 Position Tilt Mechanism. Simple Bolt On Installation. Adds Style & Safety.



Year	Description	Part No.	List
64-67	Standard Seatd -Black	HR-BK	\$296. ⁹⁵ PR
64-65	Standard Seatd -Bright Red	HR-BR	\$296. ⁹⁵ PR
66-67	Standard Seatd -Dark Red	HR-DR	\$296. ⁹⁵ PR
64-67	Light Blue	HR-LB	\$296. ⁹⁵ PR
64-67	Sport Seats -Black	SS-HR-BK	\$296. ⁹⁵ PR
64-65	Sport Seats -Bright Red	SS-HR-BR	\$296. ⁹⁵ PR
66-67	Sport Seats -Dark Red	SS-HR-DR	\$296. ⁹⁵ PR
64-67	Sport Seats -Light Blue	SS-HR-LB	\$296. ⁹⁵ PR

MACH 1 SEAT UPHOLSTERY - FULL SET



These are complete seat upholstery sets for 69-73 Mach 1 Mustangs. Our upholstery sets are the best on the market, precision made from the

same heavy duty vinyl and attention to detail originally used by Ford. Our custom colors are an exact match. Heavy 32 ounce vinyl and solid welt cord. Patterns are die cut for precision. Kits do not include hog rings for installation.



Year	Description	Part No.	
69	Black/black stripe	69-M-FULL-BK/BK	\$409. ⁹⁵ SE
69	Black/red stripe	69-M-FULL-BK/RD	\$409. ⁹⁵ SE
69	Blue/specify stripe	69-M-FULL-DB/ST	\$409. ⁹⁵ SE
69	Dark red/specify stripe	69-M-FULL-DR/ST	\$409. ⁹⁵ SE
69	White/black stripe	69-M-FULL-WT/BK	\$409. ⁹⁵ SE
69	White/red stripe	69-M-FULL-WT/RD	\$409. ⁹⁵ SE
69	White/white stripe	69-M-FULL-WT/WT	\$409. ⁹⁵ SE
70	Black/black stripe	70-M-FULL-BK/BK	\$409. ⁹⁵ SE
70	Black/gray stripe	70-M-FULL-BK/GY	\$409. ⁹⁵ SE
70	Dark blue/specify stripe	70-M-FULL-DB/ST	\$409. ⁹⁵ SE
70	Dark red/specify stripe	70-M-FULL-DR/ST	\$409. ⁹⁵ SE
70	White/gray stripe	70-M-FULL-WT/GY	\$409. ⁹⁵ SE

Year	Description	Part No.	
70	White/white stripe	70-M-FULL-WT/WT	\$409. ⁹⁵ SE
71-73	Black	71FB-M-FULL-BK	\$409. ⁹⁵ SE
71	Black/silver	71FB-M-FULL-BS	\$409. ⁹⁵ SE
71	Dark blue	71FB-M-FULL-DB	\$409. ⁹⁵ SE
71	Dark red	71FB-M-FULL-DR	\$409. ⁹⁵ SE
71	Ginger	71FB-M-FULL-GI	\$409. ⁹⁵ SE
71	Green	71FB-M-FULL-GR	\$409. ⁹⁵ SE
71	Vermillion	71FB-M-FULL-VE	\$409. ⁹⁵ SE
71	White	71FB-M-FULL-WT	\$409. ⁹⁵ SE
71-73	Black/red stripe	71-M-FULL-BK/RD	\$409. ⁹⁵ SE
72-73	Dark red	72FB-M-FULL-DR	\$409. ⁹⁵ SE
72-73	White	72FB-M-FULL-WT	\$409. ⁹⁵ SE

MACH 1 SEAT UPHOLSTERY - FRONT

Year	Description	Part No.	List
64-67	Standard Seatd -Black	HR-BK	\$296. ⁹⁵ PR
69	Black/black stripe	69-M-BUCK-BK/BK	\$294. ⁹⁵ PR
69	Black/red stripe	69-M-BUCK-BK/RD	\$294. ⁹⁵ PR
69	Dark blue/specify stripe	69-M-BUCK-DB/ST	\$294. ⁹⁵ PR
69	Dark red/specify stripe	69-M-BUCK-DR/ST	\$294. ⁹⁵ PR
69	White/red stripe	69-M-BUCK-WT/RD	\$294. ⁹⁵ PR
69	White/white stripe	69-M-BUCK-WT/WT	\$294. ⁹⁵ PR
70	Black/gray stripe	70-M-BUCK-BK/GY	\$294. ⁹⁵ PR
70	Dark blue/specify stripe	70-M-BUCK-DB/ST	\$294. ⁹⁵ PR
70	White/gray stripe	70-M-FULL-WT/GY	\$409. ⁹⁵ PR
70	White/white stripe	70-M-FULL-WT/WT	\$409. ⁹⁵ PR
70	Dark red/specify stripe	70-M-BUCK-DR/ST	\$294. ⁹⁵ PR
70	White/gray stripe	70-M-BUCK-WT/GY	\$294. ⁹⁵ PR
70	White/white stripe	70-M-BUCK-WT/WT	\$294. ⁹⁵ PR
71-73	Black/Gray stripe	71-M-BUCK-BK/GR	\$294. ⁹⁵ PR
71	Black	71-M-BUCK-BK	\$294. ⁹⁵ PR
71	Dark blue	71-M-BUCK-DB	\$294. ⁹⁵ PR
71	Dark red	71-M-BUCK-DR	\$294. ⁹⁵ PR
71-73	Ginger	71-M-BUCK-GI	\$294. ⁹⁵ PR
71	White	71-M-BUCK-WT	\$294. ⁹⁵ PR
72-73	Dark red	72FB-M-FULL-DR	\$409. ⁹⁵ PR
72-73	White	72FB-M-FULL-WT	\$409. ⁹⁵ PR
72-73	Dark blue	72-M-BUCK-DB	\$294. ⁹⁵ PR
72-73	Dark red	72-M-BUCK-DR	\$294. ⁹⁵ PR
72-73	White	72-M-BUCK-WT	\$294. ⁹⁵ PR

SHOP WITH CONFIDENCE! WE OFFER SUPERIOR-QUALITY PARTS FOR ALL YOUR MUSTANG RESTORATION NEEDS.

GRANDE SEAT UPHOLSTERY - FULL

SET



These are complete seat upholstery sets for 69-71 Grande Mustangs. Ours are the best on the market, precision made from the

same heavy duty vinyl and attention to detail originally used by Ford. Our custom colors are an exact match. Heavy 32 ounce vinyl and solid welt cord. Patterns are die cut for precision. These all come with comfortweave inserts. Rare cloth insert option is not available. Kits do not include hog rings for installation. Seat buttons sold separately.



Year	Description	Part No.	List
69	Coupe, black	69CP-G-FULL-BK	\$409 ⁹⁵ SE
69	Coupe, dark red	69CP-G-FULL-DR	\$409 ⁹⁵ SE
69	Coupe, ivy gold	69CP-G-FULL-IG	\$409 ⁹⁵ SE
69	Coupe, light blue	69CP-G-FULL-LB	\$409 ⁹⁵ SE
69	Coupe, nugget gold	69CP-G-FULL-NG	\$409 ⁹⁵ SE
69	Coupe, white	69CP-G-FULL-WT	\$409 ⁹⁵ SE
70	Coupe, black	70CP-G-FULL-BK	\$409 ⁹⁵ SE
70	Coupe, blue	70CP-G-FULL-BL	\$409 ⁹⁵ SE
70	Coupe, ginger	70CP-G-FULL-GI	\$409 ⁹⁵ SE
70	Coupe, ivy gold	70CP-G-FULL-IV	\$409 ⁹⁵ SE
70	Coupe, vermillion	70CP-G-FULL-VE	\$409 ⁹⁵ SE
70	Coupe, white	70CP-G-FULL-WT	\$409 ⁹⁵ SE
71	Coupe, black	71CP-G-FULL-BK	\$409 ⁹⁵ SE
71	Coupe, blue	71CP-G-FULL-BL	\$409 ⁹⁵ SE
71	Coupe, ginger	71CP-G-FULL-GI	\$409 ⁹⁵ SE
71	Coupe, green	71CP-G-FULL-GR	\$409 ⁹⁵ SE
71	Coupe, vermillion	71CP-G-FULL-VE	\$409 ⁹⁵ SE
71	Coupe, white	71CP-G-FULL-WT	\$409 ⁹⁵ SE

GRANDE SEAT UPHOLSTERY FRONT

Year	Description	Part No.	List
69	Black	69-G-BUCK-BK	\$294 ⁹⁵ PR
69	Dark red	69-G-BUCK-DR	\$294 ⁹⁵ PR
69	Ivy gold	69-G-BUCK-IG	\$294 ⁹⁵ PR
69	Light blue	69-G-BUCK-LB	\$294 ⁹⁵ PR
69	Nugget gold	69-G-BUCK-NG	\$294 ⁹⁵ PR
69	White	69-G-BUCK-WT	\$294 ⁹⁵ PR
70	Black	70-G-BUCK-BK	\$294 ⁹⁵ PR
70	Blue	70-G-BUCK-BL	\$294 ⁹⁵ PR
70	Ginger	70-G-BUCK-GI	\$294 ⁹⁵ PR
70	Ivy Gold	70-G-BUCK-IV	\$294 ⁹⁵ PR
70	Vermillion	70-G-BUCK-VE	\$294 ⁹⁵ PR
70	White	70-G-BUCK-WT	\$294 ⁹⁵ PR
71	Black	71-G-BUCK-BK	\$294 ⁹⁵ PR
71-73	Blue	71-G-BUCK-BL	\$294 ⁹⁵ PR
71-73	Ginger	71-G-BUCK-GI	\$294 ⁹⁵ PR
71-73	Green	71-G-BUCK-GR	\$294 ⁹⁵ PR
71-73	Vermillion	71-G-BUCK-VE	\$294 ⁹⁵ PR
71	Coupe, vermillion	71CP-G-FULL-VE	\$294 ⁹⁵ PR
71	Coupe, white	71CP-G-FULL-WT	\$294 ⁹⁵ PR

DELUXE SEAT UPHOLSTERY - FULL

SET



These are complete seat upholstery sets for 68-73 Mustangs with deluxe interiors. Ours are the best on the market, precision

made from the same heavy duty vinyl and attention to detail originally used by Ford. Our custom colors are an exact match. Heavy 32 ounce vinyl and solid welt cord. Patterns are die cut for precision. In the case of Pony patterns, they have the same detail as the originals. Kits do not include hog rings for installation. Seat buttons sold separately.



Year	Description	Part No.	List
67	FB, black w/comfort weave	67FB-D-FULL-BK	\$409 ⁹⁵ SE
68	FB, black W/comfort weave	68FB-D-FULL-BK	\$409 ⁹⁵ SE
69	CP, black	69CP-D-FULL-BK	\$409 ⁹⁵ SE
69	CP, dark red	69CP-D-FULL-DR	\$409 ⁹⁵ SE
69	CP, ivy gold	69CP-D-FULL-IG	\$409 ⁹⁵ SE
69	CP, light blue	69CP-D-FULL-LB	\$409 ⁹⁵ SE
69	CP, nug gold	69CP-D-FULL-NG	\$409 ⁹⁵ SE
69	CP, white	69CP-D-FULL-WT	\$409 ⁹⁵ SE
69	CV, black	69CV-D-FULL-BK	\$409 ⁹⁵ SE
69	CV, dark red	69CV-D-FULL-DR	\$409 ⁹⁵ SE
69	CV, ivy gold	69CV-D-FULL-IG	\$409 ⁹⁵ SE
69	CV, light blue	69CV-D-FULL-LB	\$409 ⁹⁵ SE
69	CV, nug gold	69CV-D-FULL-NG	\$409 ⁹⁵ SE
69	CV, white	69CV-D-FULL-WT	\$409 ⁹⁵ SE
69	FB, dark red	69FB-D-FULL-DR	\$409 ⁹⁵ SE
69	FB, ivy gold	69FB-D-FULL-IG	\$409 ⁹⁵ SE
69	FB, light blue	69FB-D-FULL-LB	\$409 ⁹⁵ SE
69	FB, nug gold	69FB-D-FULL-NG	\$409 ⁹⁵ SE
69	FB, white	69FB-D-FULL-WT	\$409 ⁹⁵ SE
70	CP, black	70CP-D-FULL-BK	\$409 ⁹⁵ SE
70	CP, blue	70CP-D-FULL-BL	\$409 ⁹⁵ SE
70	CP, ginger	70CP-D-FULL-GI	\$409 ⁹⁵ SE
70	CP, ivy gold	70CP-D-FULL-IV	\$409 ⁹⁵ SE
70	CP, vermillion	70CP-D-FULL-VE	\$409 ⁹⁵ SE
70	CP, white	70CP-D-FULL-WT	\$409 ⁹⁵ SE
70	CV, black	70CV-D-FULL-BK	\$409 ⁹⁵ SE
70	CV, blue	70CV-D-FULL-BL	\$409 ⁹⁵ SE
70	CV, ginger	70CV-D-FULL-GI	\$409 ⁹⁵ SE
70	CV, ivy gold	70CV-D-FULL-IV	\$409 ⁹⁵ SE
70	CV, vermillion	70CV-D-FULL-VE	\$409 ⁹⁵ SE
70	CV, white	70CV-D-FULL-WT	\$409 ⁹⁵ SE
70	FB, black	70FB-D-FULL-BK	\$409 ⁹⁵ SE
70	FB, blue	70FB-D-FULL-BL	\$409 ⁹⁵ SE
70	FB, ginger	70FB-D-FULL-GI	\$409 ⁹⁵ SE
70	FB, ivy gold	70FB-D-FULL-IV	\$409 ⁹⁵ SE
70	FB, vermillion	70FB-D-FULL-VE	\$409 ⁹⁵ SE
70	FB, white	70FB-D-FULL-WT	\$409 ⁹⁵ SE
71	CP, black	71CP-D-FULL-BK	\$409 ⁹⁵ SE

Year	Description	Part No.	List
71	CP, blue	71CP-D-FULL-BL	\$409 ⁹⁵ SE
71	CP, ginger	71CP-D-FULL-GI	\$409 ⁹⁵ SE
71	CP, green	71CP-D-FULL-GR	\$409 ⁹⁵ SE
71	CP, vermillion	71CP-D-FULL-VE	\$409 ⁹⁵ SE
71	CP, white	71CP-D-FULL-WT	\$409 ⁹⁵ SE
71	CV, black	71CV-D-FULL-BK	\$409 ⁹⁵ SE
71	CV, blue	71CV-D-FULL-BL	\$409 ⁹⁵ SE
71	CV, ginger	71CV-D-FULL-GI	\$409 ⁹⁵ SE
71	CV, green	71CV-D-FULL-GR	\$409 ⁹⁵ SE
71	CV, vermillion	71CV-D-FULL-VE	\$409 ⁹⁵ SE
71	CV, white	71CV-D-FULL-WT	\$409 ⁹⁵ SE
71	FB, black	71FB-D-FULL-BK	\$409 ⁹⁵ SE
71	FB, blue	71FB-D-FULL-BL	\$409 ⁹⁵ SE
71	FB, ginger	71FB-D-FULL-GI	\$409 ⁹⁵ SE
71	FB, green	71FB-D-FULL-GR	\$409 ⁹⁵ SE
71	FB, vermillion	71FB-D-FULL-VE	\$409 ⁹⁵ SE
71	FB, white	71FB-D-FULL-WT	\$409 ⁹⁵ SE
72-73	CP, black	72CP-D-FULL-BK	\$409 ⁹⁵ SE
72-73	CP, blue	72CP-D-FULL-BL	\$409 ⁹⁵ SE
72-73	CP, ginger	72CP-D-FULL-GI	\$409 ⁹⁵ SE
72-73	CP, green	72CP-D-FULL-GR	\$409 ⁹⁵ SE
72-73	CP, vermillion	72CP-D-FULL-VE	\$409 ⁹⁵ SE
72-73	CP, white	72CP-D-FULL-WT	\$409 ⁹⁵ SE
72-73	CV, black	72CV-D-FULL-BK	\$409 ⁹⁵ SE
72-73	CV, blue	72CV-D-FULL-BL	\$409 ⁹⁵ SE
72-73	CV, ginger	72CV-D-FULL-GI	\$409 ⁹⁵ SE
72-73	CV, green	72CV-D-FULL-GR	\$409 ⁹⁵ SE
72-73	CV, vermillion	72CV-D-FULL-VE	\$409 ⁹⁵ SE
72-73	CV, white	72CV-D-FULL-WT	\$409 ⁹⁵ SE
72-73	FB, black	72FB-D-FULL-BK	\$409 ⁹⁵ SE
72-73	FB, blue	72FB-D-FULL-BL	\$409 ⁹⁵ SE
72-73	FB, ginger	72FB-D-FULL-GI	\$409 ⁹⁵ SE
72-73	FB, green	72FB-D-FULL-GR	\$409 ⁹⁵ SE
72-73	FB, vermillion	72FB-D-FULL-VE	\$409 ⁹⁵ SE
72-73	FB, white	72FB-D-FULL-WT	\$409 ⁹⁵ SE

DELUXE UPHOLSTERY FRONT

Year	Description	Part No.	List
69	Black	69-D-BUCK-BK	\$294 ⁹⁵ PR
69	Dark red	69-D-BUCK-DR	\$294 ⁹⁵ PR
69	Ivy gold	69-D-BUCK-IG	\$294 ⁹⁵ PR
69	Light blue	69-D-BUCK-LB	\$294 ⁹⁵ PR
69	Nug gold	69-D-BUCK-NG	\$294 ⁹⁵ PR
69	White	69-D-BUCK-WT	\$294 ⁹⁵ PR
70	Black	70-D-BUCK-BK	\$294 ⁹⁵ PR
70	Blue	70-D-BUCK-BL	\$294 ⁹⁵ PR
70	Ginger	70-D-BUCK-GI	\$294 ⁹⁵ PR
70	Ivy gold	70-D-BUCK-IV	\$294 ⁹⁵ PR
70	Vermillion	70-D-BUCK-VE	\$294 ⁹⁵ PR
70	White	70-D-BUCK-WT	\$294 ⁹⁵ PR
71	Black	71-D-BUCK-BK	\$294 ⁹⁵ PR
71	Blue	71-D-BUCK-BL	\$294 ⁹⁵ PR
71	Ginger	71-D-BUCK-GI	\$294 ⁹⁵ PR
71	Green	71-D-BUCK-GR	\$294 ⁹⁵ PR
71	Vermillion	71-D-BUCK-VE	\$294 ⁹⁵ PR

WE PROUDLY FEATURE AUTHENTIC MUSTANG REPRODUCTIONS FROM SCOTT DRAKE!



71	White	71-D-BUCK-WT	\$294.95 PR
72-73	Black	72-D-BUCK-BK	\$294.95 PR
72-73	Blue	72-D-BUCK-BL	\$294.95 PR
72-73	Ginger	72-D-BUCK-GI	\$294.95 PR
72-73	Green	72-D-BUCK-GR	\$294.95 PR
72-73	Vermillion	72-D-BUCK-VE	\$294.95 PR
72-73	White	72-D-BUCK-WT	\$294.95 PR

HOG RING KIT



Our hog ring installation kits each feature pliers and 150 hog rings included (enough for 1 set).
Economy kit pictured.

Year	Description	Part No.	List
64-73	Economy, simple pliers	PLIERSET-E	\$7.95 KI
64-73	Medium, upgrade cast pliers	PLIERSET-M	\$14.95 KI
64-73	Pro, spring-loaded pliers	PLIERSET-P	\$22.95 KI

SEAT UPHOLSTERY BOLSTER SET



Great time saver!
Originals are usually all bent up and rusty making them difficult to install in new upholstery kits.

Part No.	Year	Description	List
C5ZZ-63667A00-S	64-66	Standard 4 piece	\$10.95 SEJ141

SEAT BACKBOARD



Features correct grain and embossed stitching. Paint to match. Fits standard and deluxe seats.

Part No.	Year	Description	List
C9ZZ-6560762	69-70	Black Injection Molded Concours	\$57.95 EA
C9ZZ-6560762-W	69-70	White Injection Molded Concours	\$57.95 EA
D1ZZ-6560762	71	Black, ABS plastic	\$79.95 PR
D2ZZ-6560762	72-73	Black, ABS plastic	\$79.95 PR



67: Deluxe, includes back plate (4 required per car)
C8ZB-6564824-K

List
\$12.95 KI



68: Deluxe, includes back plate (8 required per car)
C8ZB-6564824-K

List
\$12.95 KI



69-70: Deluxe, teak and walnut (69 cars require 4 pairs, 70 cars require 5 pairs)
C9ZZ-6564824-W

List
\$15.50 PR



71-73: Mach 1
D1ZZ-6564824-K

List
\$12.95 KI



71-73: Grande
D1ZB-6564824-K

List
\$14.95 PR

SEAT CUSHION



Replace your old worn out seat cushions. Excellent reproductions made from the same type of foam as the originals.

Part No.	Year	Description	List
C5ZZ-6560050/1P	65-66	Pony	\$56.95 EA
C5ZZ-6560050/1S	64-66	Standard	\$56.95 EA
C7ZZ-6560050/1S	67	Standard/deluxe	\$56.95 EA
C8ZZ-6560050/1S	68	Standard/deluxe	\$56.95 EA
C9ZZ-6560050/1M	69-70	Highback, Mach 1/ Shelby	\$84.95 EA
C9ZZ-6560050/1S	69	Lowback, standard	\$61.95 EA
D0ZZ-6560050/1S	70	Highback, standard	\$84.95 EA
D1ZZ-6560050/1S	71-73	Highback, All	\$119.95 EA

SEAT WARMER



Now available from Scott Drake! You can now have the same comfort of your new car, in your classic Mustang. Kit does one seat and features two 11"x22" pads, high and low settings, trimmable so one size fits all, even heat distribution, and an 8 ft long switch harness.

Year	Part No.	List
64-73	ACC-SW	\$89.95 EA

FASTBACK REAR SEAT CUSHION



Now available for 1965-70 Fastbacks. Set includes top hump and bottom cushions.

Year	Description	Part No.	List
65-70	Fastback, 3-piece set U.S.A.	C5ZZ-6360080/32	\$186.95 SE
65-70	Fastback, 3-piece set, import	C5ZZ-6360080-B	\$139.95 EA

SEAT LATCH HANDLE AND BEZEL SET



Exact detail and beautiful chrome. These handles & bezels are commonly pitted, broken or missing.

Our 6 piece kit does both front seats.

Year	Part No.	List
68-69	C8AZ6262622/72A	\$19.95 KI
70	C9AZ-626262272A	\$19.95 KI



71 Late-73
D1FZ-6262622B/C

List
\$29.95 KI

ALUMINUM SEAT SIDE MOLDING



Stamped aluminum as originals, clear anodized plated.

Part No.	Year	Desc	List
C5ZZ-6561616-AR	64-66	RH	\$21.95 EA
C5ZZ-6561617-AR	64-66	LH	\$21.95 EA
C7ZZ-6561616-AR	67	RH	\$24.95 EA
C7ZZ-6561617-AR	67	LH	\$24.95 EA

SEAT SIDE MOLDING MOUNT KIT



This kit contains all the original style parts to mount the seat side molding. Does one seat.

Year	Description	Part No.	List
65-66	6 pieces	C5ZZ-65616167MK	\$8.95 KI
67	6 pieces	C7ZZ-65616167MK	\$8.95 KI

SEAT BACK ADJUSTING KIT



Includes pair of chrome screw adjusters, nuts and washers, heavy duty plastic rest plates and attaching screws.

Year	Part No.	List
64-67	C1DZ-6461643	\$9.95 KI

SEAT STOP BUMPER KIT



These seat bumpers install between the seat cushion and seat back. Year many other Ford/Mercury seats.

Year	Part No.	List
68-73	C8ZZ-6560310/1	\$7.95 ^{KI}

SEAT HINGE COVER



These hinge covers are exact copies of the originals. Exterior molded plastic.

Year	Description	Part No.	List
64-67	Black	C5ZZ-6561692/3B	\$15.95 ^{PR}
64-67	Neutral	C5ZZ-6561692/3N	\$15.95 ^{PR}



These hinge covers are exact copies of the originals. Exterior molded plastic.

Year	Description	Part No.	List
68-70	Black	C8AZ-6561692/5B	\$32.95 ^{SE}
68-70	Neutral	C8AZ-6561692/5N	\$32.95 ^{SE}



These hinge covers are exact copies of the originals. Exterior molded plastic.

Year	Description	Part No.	List
71-73	Black	D1ZZ-6561692/3	\$23.95 ^{PR}

FRONT SEAT HINGE SHAFT RETAINER CLIP SET



Special clip used to secure front seat back to seat bottom. Two required per seat.

Year	Description	Part No.	List
64-70	Set of 4	352358-SK	\$2.50 ^{SE}

FRONT SEAT WASHER



Install on seat hinge shaft between the seat and hinge to prevent hinge from wearing through upholstery.

Year	Description	Part No.	List
65-73	Set of 4	373249-S	\$2.95 ^{SE}

DELUXE SEAT SIDE PANEL

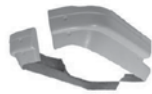

Nice quality fiber glass reproductions to replace commonly broken moldings. No hardware or brackets included. Paint to match fiberglass.

Year	Description	Part No.	List
67	Pair	C7ZZ-6567186/7	\$94.95 ^{PR}

COMPLETE SEAT FRAME



Complete seat frame, includes seat back, seat bottom and springs. Seat tracks sold separately

Year	Description	Part No.	List
65-67	LH	C5ZZ-6563103-5	\$399.95 ^{EA}

SEAT BOTTOM FRAME



The bottom frame and spring assembly for the bucket seat.

Year	Description	Part No.	List
64-67	RH	C5ZZ-6563100-A	\$154.95 ^{EA}
64-67	LH	C5ZZ-6563101-A	\$154.95 ^{EA}

FRONT SEAT SPRING ASSEMBLY



The spring assembly for the bucket seat. Choose from bottom spring assembly or backrest spring assembly. Replaces broken or rusty springs on original frames.

Year	Description	Part No.	List
64-67	Bottom	C5ZZ-6563104-B	\$64.95 ^{EA}
64-67	Backrest	C5ZZ-6563105-B	\$64.95 ^{EA}

SEAT HINGE REPAIR BRACKET



A very common breaking point can now be easily repaired.

Year	Description	Part No.	List
68-70	Inner, LH	D7ZZ-69618C46-A	\$34.95 ^{EA}

SEAT TRACK ASSEMBLY



These replacement seat track assemblies come with everything necessary to replace those hard to move or broken originals. Each set does one seat.

Year	Part No.	List
64-68	C5ZZ-6561704/5	\$62.50 ^{EA}
69-70	C9ZZ-6561704/5	\$64.95 ^{EA}

SEAT TRACK ADJUSTER



New from Scott Drake is the 1964-70 Mustang Bucket Seat Track Adjuster. This commonly missing part is a must to keep bucket seats functioning properly

Year	Part No.	List
64-70	C5ZZ-6561726-A	\$9.95 ^{EA}

SEAT ADJUSTER KNOB



Knob to adjust forward and back motion of seat slider.

Year	Part No.	List
65-72	CSAZ-6261753-BA	\$4.95 ^{EA}

SEAT TRACK PLATE



Heavy steel plates, stamped in the original gauge steel. Painted black, sold individually or in sets of eight.

Year	Description	Part No.	List
64-67	Bulk	C5ZZ-13190-A	\$1.50 ^{EA}
64-67	Set of 8	C5ZZ-13190-K	\$10.00 ^{SE}

SEAT TRACK SPRING SET



Includes all the springs necessary to rebuild one seat. Black phosphorous plated.

Year	Part No.	List
64-70	C5ZZ-6561828/83	\$10.95 ^{KI}

**WE PROUDLY FEATURE AUTHENTIC MUSTANG
REPRODUCTIONS FROM SCOTT DRAKE!**



REAR DECK & QUARTER PANELS

FASTBACK FOLD DOWN SEAT LATCH

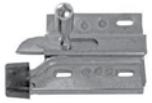

Complete latch includes main body, chrome sliding latch, chrome knob and rubber bumper.

Year	Description	Part No.	List
65	RH	C5ZZ-6361382-A	\$51.95 ^{EA}
66	LH	C6ZZ-6361382-A	\$51.95 ^{EA}
67-70	RH	C7ZZ-6361382-A	\$49.95 ^{EA}
67-70	LH	C7ZZ-6361383-A	\$49.95 ^{EA}

FASTBACK REAR SEAT LATCH COVER PLATE



Textured like originals. Paint to match.

Year	Description	Part No.	List
65		C5ZZ-63613B26-A	\$28.95 ^{EA}
66		C6ZZ-63613B26-A	\$27.95 ^{EA}
67-68	Fixed rear seat	C7ZZ-63613B26/7	\$59.95 ^{PR}
67-68	Fold-down, RH	C7ZZ-63613B26-A	\$28.95 ^{EA}
67-68	Fold-down, LH	C7ZZ-63613B27-A	\$28.95 ^{EA}

FASTBACK REAR SEAT LATCH KNOB

We offer these 100% correct copies of the original parts for the discriminating Mustang owner. Made from machined steel, then heavily chrome plated.



65-66
C5ZZ-6362418-B

List
\$9.95^{EA}



67-70
C7ZZ-6362418-B

List
\$9.95^{EA}

FASTBACK REAR SEAT HARDWARE



Kit includes all rests, bumpers and guides for a complete job. Ten pieces in each kit. C6ZZ-6360575-K version pictured.

Year	Description	Part No.	List
65	Early	C5ZZ-6360575-K	\$26.95 ^{KI}
65-66		C6ZZ-6360575-K	\$33.45 ^{KI}

FASTBACK REAR SEAT SUPPORT

Chrome plated heavy gauge steel. Supports seat when raised.



65
C5ZZ-6360575-A

List
\$9.95^{PR}



65-70
C6ZZ-6360575-A

List
\$13.95^{PR}

REAR SPORT DECK BRACKET



The brackets that secure the rear section of the sport deck to the car.

Year	Part No.	List
65-70	C5ZZ-63424A78-A	\$12.95 ^{EA}

FASTBACK FOLD DOWN SEAT MOLDING



Stamped steel construction and chrome plated. Complete kit which includes hinge.

Year	Part No.	List
65-68	C5ZZ-63130A18-K	\$249.95 ^{KI}
69-70	C9ZZ-63130A18-K	\$254.95 ^{KI}

FASTBACK REAR SEAT GUIDE



Black injection molded plastic just like the originals. This part is a fast seller, as most originals are damaged or missing.

Year	Part No.	List	
65-66	C5ZZ-63613B28-B	\$8.00 ^{EA}	
67-70	polished S/S	C7ZZ-63613B28/9	\$29.95 ^{PR}

TRAP DOOR PROP ASSEMBLY



Year	Description	Part No.	List
65-66	Assembly	C5ZZ-6345734-A	\$69.95 ^{EA}

TRAP DOOR PROP ROD

This part allows you to easily prop open the trap door and hold it in the open position.



67-68
C7ZZ-6345734-A

List
\$33.95^{EA}



69-70
C9ZZ-6345734-A

List
\$42.95^{EA}

FASTBACK TRAP DOOR LATCH CATCH



The catch to secure the trap door latch.

Year	Part No.	List
65-70	C5ZZ-63605A44-A	\$12.95 ^{EA}

FASTBACK TRAP DOOR LATCH



Holds trap door in place. Galvanized to prevent rust.

Year	Part No.	List
65-68	C5ZZ-6345704-A	\$29.95 ^{EA}
69-70	C7ZZ-6345704-A	\$32.95 ^{EA}

FASTBACK TRAP DOOR HINGE



Exact detail of the original hinges. Painted black. Ready to install.

Year	Description	Part No.	List
65-66	Pair	C5ZZ-6345702-A	\$36.95 ^{PR}
67-70		C7ZZ-6345702	\$25.95 ^{EA}

METAL FASTBACK TRAP DOOR



This fastback trap door panel is made of original gauge sheet metal and finished with the correct embossed texture. Painted satin black.

Year	Part No.	List
65-66	C5ZZ-6345728-A	\$224.95 ^{EA}
67-68	M3661	\$224.95 ^{EA}
69-70	C9ZZ-6345728-A	\$224.95 ^{EA}

ABS PLASTIC FASTBACK TRAP DOOR



This fastback trap door panel is made of sturdy ABS plastic and features built in speaker pads.

Year	Part No.	List
65-66	C5Z-6345728-SP	\$149 ⁹⁵ EA
67-70	C7Z-6345728-SP	\$149 ⁹⁵ EA

FASTBACK REAR TRIM PANEL

This part is commonly sun damaged. Also, required when converting over to a fold-down car on 1969-70.



65-66: 5 piece set
C5Z-63311123-K

List
\$284⁹⁵ SE



67-68: 5 piece set
C7Z-63311123-K

List
\$249⁹⁵ SE



67-68: Full set
C7Z6331144/83K

List
\$249⁹⁵ SE



69-70: Upper
C9Z-6331111/2B

List
\$104⁹⁵ PR



69-70: Side panels
C9Z-633112/3-A

List
\$214⁹⁵ PR

UPPER REAR TRIM PANEL BRACKETS



These brackets are required when adding a fold-down seat option to a non fold-down car. Mounting screws not included.

Year	Part No.	List
69-70	C7S-6342468-B	\$39 ⁹⁵ SE

FASTBACK REAR TRIM CENTER CAP



Stamped steel trim cap used to attach narrow fastback interior moldings.

Year	Part No.	List
65-66	C5Z-63291C12-A	\$9 ⁹⁵ EA

FASTBACK UPPER PANEL JOINT COVER



Painted black and pre-stamped with mounting hole. An exact fit.

Year	Description	Part No.	List
65-66	Fastback	C5Z-6342353-A	\$12 ⁹⁵ EA

FASTBACK VENTED QUARTER PANEL TRIM



A beautiful reproduction, these panels are black ABS plastic with shiny chrome grilles for inner quarter trim.

Year	Description	Part No.	List
67-68	Black	C7Z-63310A06/7	\$264 ⁹⁵ PR

FASTBACK INTERIOR VENT GRILL



Made from ABS plastic so you will never have to worry about the pocking associated with the originals. Beautifully chrome plated with the

recessed areas painted black to look like originals. Cleverly designed to install with small screws from the backside, for simple installation. Sold as a pair with mounting screws included.

Year	Part No.	List
67-68	C7Z-6331067-VG	\$109 ⁹⁵ PR

FASTBACK VENT SLIDE

A beautiful reproduction of a commonly pitted part. Our slides are made of zinc die-cast, and finished with highly polished chrome. Mounting hardware included.



65-66
C5Z-63278C20/1

List
\$44⁹⁵ SE

67-68
C7Z-63278C48/9

List
\$44⁹⁵ SE

FASTBACK VENT SLIDE BEZEL



Beautifully chromed stamped steel bezels to replace those nasty originals.

Year	Part No.	List
65-66	C5Z-6331002/3	\$22 ⁹⁵ PR

FASTBACK INTERIOR QUARTER PANEL

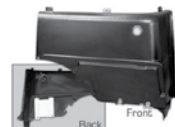

65-66: Fastback, ABS includes steel reinforcement and courtesy lights
C5Z-63314867-K

List
\$404⁹⁵ KI



67-68: Fastback, ABS includes steel reinforcement and courtesy lights
C7Z-63314867-K

List
\$349⁹⁵ PR



69-70: ABS plastic, Fastback
C9Z-63314867/P

List
\$324⁹⁵ PR



69-70: ABS plastic, Fastback, W/ speaker pods
C9Z-63314867/SP

List
\$209⁹⁵ PR



71-73: ABS plastic, Fastback
D1Z-63314867/P

List
\$184⁹⁵ PR

FASTBACK QUARTER PANEL LIGHT

These interior quarter lights are exact copies of the originals. Features include our high quality chrome finish, correct connector and the flat index to orient the light in the correct position. These are not "one size fits all" like the competition.



65-68: Fastback
C4S-13776-B

List
\$39⁹⁵ EA



69-70: Fastback
D0AZ-13776-A

List
\$39⁹⁵ EA

QUARTER GLASS PIVOT ROD COVER



A nice reproduction of the rubber cover for the quarter glass pivot.

Year	Part No.	List
69-70	C9Z-6330246	\$16 ⁹⁵ PR

WE PROUDLY FEATURE AUTHENTIC MUSTANG REPRODUCTIONS FROM SCOTT DRAKE!



QUARTER PANEL TRIM CAP

These are excellent reproductions. Sold in pairs only. Black plastic with correct texture.



69-70: Fastback
C9ZZ-6331490/1A

List
\$16.95 PR

FIBERGLASS & FIBERBOARD PACKAGE TRAY



For Premium Quiteride Package trays see the Accoustishield Pre-Cut Kits earlier in this section.

Year	Description	Part No.	List
64-68	Coupe, fiberboard	C5ZZ-6546656	\$14.95 EA
67-68	Fastback, fiberboard, No fold down seat	C7ZZ-6346656	\$23.95 EA
69-70	Fastback, fiberglass	C9ZZ-6346656	\$79.95 EA
69-70	Coupe, fiberglass	C9ZZ-6546656	\$76.95 EA
69-70	Fastback, fiberboard	C9ZZ-6546656-C	\$61.95 EA

PACKAGE TRAY RETAINER



1964-70 Mustang Coupe Package Tray Retainers are the perfect fit for your Package Tray. Made as originals, they feature stamped steel with a black finish to prevent rust. Unique clips included.

Year	Description	Part No.	List
65-70	Coupe	C4AZ-6246698-K	\$8.95 PR

PACKAGE TRAY WITH SPEAKER PADS



Molded from sturdy ABS plastic these feature 6"x 9" speaker pads tilted forward for better sound. Eliminates the need to cut metal package tray framework.

Year	Description	Part No.	List
64-67	Coupe, W/speaker pads	C5ZZ-6546656-SP	\$89.95 EA
68	Coupe, W/speaker pads	C8ZZ-6546656-SP	\$89.95 EA
69-70	Coupe, W/speaker pads	C9ZZ-6546656-SP	\$89.95 EA
69-70	Fastback, W/speaker pads	C9ZZ-6346656-SP	\$159.95 EA

COUPE VINYL PACKAGE TRAY WITH HOLES



Designed to match your interior for a clean, finished look. Made of tough Masonite® and vinyl. Easy to install. These come with precut speaker holes.

Year	Description	Part No.	List
64-67	Black	C5ZZ-6546656BKH	\$58.95 EA
64-67	Aqua	C5ZZ-6546656AQH	\$58.95 EA
65	Dark blue	C5ZZ-6546656BLH	\$58.95 EA
66-67	Dark red	C5ZZ-6546656DRH	\$58.95 EA
66	Emberglow	C5ZZ-6546656EMH	\$58.95 EA
65-67	Ivy gold	C5ZZ-6546656IGH	\$58.95 EA
65-67	Light blue	C5ZZ-6546656LBH	\$58.95 EA
65	Palomino	C5ZZ-6546656PAH	\$58.95 EA
66	Parchment	C5ZZ-6546656PRH	\$58.95 EA
65	Red	C5ZZ-6546656RDH	\$58.95 EA
65-66	White	C5ZZ-6546656WTH	\$58.95 EA
68	Black	C7ZZ-6546656BKH	\$58.95 EA
68	Aqua	C7ZZ-6546656AQH	\$58.95 EA
68	Dark red	C7ZZ-6546656DRH	\$58.95 EA
68	Ivy gold	C7ZZ-6546656IGH	\$58.95 EA
68	Light blue	C7ZZ-6546656LBH	\$58.95 EA
68	Parchment	C7ZZ-6546656PRH	\$58.95 EA
68	Saddle	C7ZZ-6546656SAH	\$58.95 EA
68	Dark red	C8ZZ-6546656DRH	\$58.95 EA
68	Nugget gold	C8ZZ-6546656NGH	\$58.95 EA

COUPE VINYL PACKAGE TRAY



Designed to match your interior for a clean, finished look. Made of tough Masonite® and vinyl. Easy to install. Also available with speaker holes.

Year	Description	Part No.	List
64-68	Black	C5ZZ-6546656-BK	\$45.95 EA
65-68	Aqua	C5ZZ-6546656-AQ	\$45.95 EA
64-65	Dark blue	C5ZZ-6546656-BL	\$45.95 EA
66-67	Dark red	C5ZZ-6546656-DR	\$45.95 EA
65-66	Emberglow	C5ZZ-6546656-EM	\$45.95 EA
65-68	Ivy gold	C5ZZ-6546656-IG	\$45.95 EA
65-68	Light blue	C5ZZ-6546656-LB	\$45.95 EA
65	Palomino	C5ZZ-6546656-PA	\$45.95 EA
66	Parchment	C5ZZ-6546656-PR	\$45.95 EA
65	Bright red	C5ZZ-6546656-RD	\$45.95 EA
65-66	White	C5ZZ-6546656-WT	\$45.95 EA
67-68	Parchment	C7ZZ-6546656-PR	\$45.95 EA
67-68	Saddle	C7ZZ-6546656-SA	\$45.95 EA
68	Dark red	C8ZZ-6546656-DR	\$45.95 EA
68	Nugget gold	C8ZZ-6546656-NG	\$45.95 EA

QUARTER PANEL WINDLACE



These are the upholstery strips that finish off the inside quarter panel at the door jamb. All body styles.

Regular windlace is next to headliners later in this section.

Year	Description	Part No.	List
69-70	Black	C9ZZ-6531290-BK	\$37.95 PR
69	Dark Red	C9ZZ-6531290-DR	\$37.95 PR
69	Ivy Gold	C9ZZ-6531290-IG	\$37.95 PR
69	Light Blue	C9ZZ-6531290-LB	\$37.95 PR
69	Nugget Gold	C9ZZ-6531290-NG	\$37.95 PR
69-70	White	C9ZZ-6531290-WT	\$37.95 PR
70	Ginger	DOZZ-6531290-GI	\$37.95 PR
70	Ivy green	DOZZ-6531290-IG	\$37.95 PR
70	Medium blue	DOZZ-6531290-MB	\$37.95 PR
71-73	Black	D1ZZ-6531290-BK	\$37.95 PR
71-73	Blue	D1ZZ-6531290-BL	\$37.95 PR
71-73	Ginger	D1ZZ-6531290-GI	\$37.95 PR
71-73	White	D1ZZ-6531290-WT	\$37.95 PR

CONVERTIBLE QUARTER PANEL TRIM



Die cut and carefully sewn to assure you of a proper fit. Made from the original type upholstery material. Original equipment on all convertibles. See "Convertible" section for boot snaps, available part #C5ZZ-7602628-A

Year	Description	Part No.	List
64-68	Black	C5ZZ-76607623BK	\$45.95 PR
65	Bright red	C5ZZ-76607623BR	\$45.95 PR
65-66	Palomino	C5ZZ-76607623PA	\$45.95 PR
64-65	Medium blue	C6ZZ-74407423BL	\$45.95 PR
65-68	Aqua	C6ZZ-76607623AQ	\$45.95 PR
66-67	Dark red	C6ZZ-76607623DR	\$45.95 PR
66	Emberglow	C6ZZ-76607623EM	\$45.95 PR
65-68	Light blue	C6ZZ-76607623LB	\$45.95 PR
66	Parchment	C6ZZ-76607623PR	\$45.95 PR
64-65	White	C6ZZ-76607623WT	\$45.95 PR
65-68	Ivy gold	C7ZZ-76607623IG	\$45.95 PR
67-68	Light parchment	C7ZZ-76607623LP	\$45.95 PR
67-68	Saddle	C7ZZ-76607623SA	\$45.95 PR
68	Maroon	C8ZZ-76607623MR	\$45.95 PR
68	Nugget gold	C8ZZ-76607623NG	\$45.95 PR
69-70	Black	C9ZZ-76607623BK	\$45.95 PR
69-70	Light blue	C9ZZ-76607623BL	\$45.95 PR
69-70	Ivy gold	C9ZZ-76607623IG	\$45.95 PR
69-70	Medium blue	C9ZZ-76607623MB	\$45.95 PR
69-70	White	C9ZZ-76607623WT	\$45.95 PR

COUPE QUARTER PANEL TRIM



Die cut and carefully sewn to assure your customers of a proper fit. Made from the original type upholstery material. Original equipment on all convertibles and coupes with deluxe interiors.

Year	Description	Part No.	List
64-68	Black	C5ZZ-65607623BK	\$45.95 ^{PR}
65	Bright red	C5ZZ-65607623BR	\$45.95 ^{PR}
65-68	Light blue	C5ZZ-65607623LB	\$45.95 ^{PR}
65-68	Palomino	C5ZZ-65607623PA	\$45.95 ^{PR}
65-68	Aqua	C6ZZ-65607623AQ	\$45.95 ^{PR}
64-65	Medium blue	C6ZZ-65607623BL	\$45.95 ^{PR}
66	Dark red	C6ZZ-65607623DR	\$45.95 ^{PR}
65-68	Emberglow	C6ZZ-65607623EM	\$45.95 ^{PR}
66-68	Parchment	C6ZZ-65607623PR	\$45.95 ^{PR}
65-68	Turquoise	C6ZZ-65607623TQ	\$45.95 ^{PR}
65-68	White	C6ZZ-65607623WT	\$45.95 ^{PR}
65-68	Ivy gold	C7ZZ-65607623IG	\$45.95 ^{PR}
67-68	Parchment	C7ZZ-65607623LP	\$45.95 ^{PR}
67	Saddle	C7ZZ-65607623SA	\$45.95 ^{PR}
68	Maroon	C8ZZ-65607623MR	\$45.95 ^{PR}
68	Nugget gold	C8ZZ-65607623NG	\$45.95 ^{PR}

QUARTER PANEL TRIM CAP

These are excellent reproductions. Sold in pairs only. 65-66 version is made from polished stainless.



65-66: Coupe, Pony interior
C5ZZ-6531490/1

List
\$20.95^{PR}

QUARTER PANEL ASH TRAY COVER



Exact reproduction of the original ash trays for the convertible. Stainless cover with plastic handle, and exact reproduction formed ashtray. Tray is zinc plated stamped steel.

Year	Part No.	List
64-70	C1AB-7630714-A	\$24.95 ^{EA}

QUARTER PANEL ASH TRAY RECEPTACLE



Exact reproduction of the original ash trays for the convertible. Stainless cover with plastic handle, and exact reproduction formed ashtray. Tray is zinc plated stamped steel.

Year	Part No.	List
65-68	CSAZ-7630702-A	\$19.95 ^{EA}

CONVERTIBLE INTERIOR QUARTER

PANEL

64-66:
Steel w/ embossed grain, RH
C5ZZ-7631004-R
64-66: Steel w/ embossed grain, LH
C5ZZ-7631005-L

List

\$114.95^{EA}

C5ZZ-7631486/7A
64-68: Convertible

List

\$159.95^{PR}

D1ZZ-7631486/7A
71-73: Convertible ABS Plastic

List

\$174.95^{PR}



CONVERTIBLE QUARTER PANEL TRIM PAD KIT



1964-68 Mustang
Convertible Quarter Panel
Trim Pad Kit.

Year	Part No.	List
64-68	C5ZZ-76314867PK	\$28.95 ^{KT}

CONVERTIBLE INTERIOR QUARTER PANEL SNAP KIT

New and Improved Design that is much easier to install and much more durable than original tubular Rivet that must be crimped over. Serrated Flanged Nut prevents Snaps from pulling out and nuts from backing off. A real Time saver from original design.



Year	Part No.	List
64-68	C5ZZ-7602628-A	\$10.95 ^{SE}

INTERIOR FASTENER KIT



Now available from Scott Drake, Interior Assembly Fastener Kits! These comprehensive kits include

almost every fastener needed for your vehicle's interior. Each application within the kit is separately packaged so you know exactly where it goes, and most oval head sheet metal screws in our kits are stainless with chrome, black, or zinc finish.

Year	Description	Part No.	List
65-66	Fastback, standard	KIT-65Z-63A	\$149.95 ^{KT}
65-66	Fastback, deluxe	KIT-65Z-63B	\$149.95 ^{KT}
65-66	Coupe, standard	KIT-65Z-65A	\$90.00 ^{KT}
65-66	Coupe, deluxe	KIT-65Z-65B	\$90.00 ^{KT}
65-66	Convertible, standard	KIT-65Z-76A	\$90.00 ^{KT}
65-66	Convertible, deluxe	KIT-65Z-76B	\$90.00 ^{KT}
67	Fastback, standard	KIT-67Z-63A	\$129.95 ^{KT}
67	Fastback, deluxe	KIT-67Z-63B	\$149.95 ^{KT}
67	Coupe, standard	KIT-67Z-65A	\$90.00 ^{KT}
67	Coupe, deluxe	KIT-67Z-65B	\$107.00 ^{KT}
67	Convertible, Standard	KIT-67Z-76A	\$90.00 ^{KT}
67	Convertible, deluxe	KIT-67Z-76B	\$107.00 ^{KT}
68	Fastback	KIT-68Z-63	\$149.95 ^{KT}
68	Coupe	KIT-68Z-65	\$90.00 ^{KT}
68	Convertible	KIT-68Z-76	\$90.00 ^{KT}
69	Fastback	KIT-69Z-63	\$125.00 ^{KT}
69	Coupe	KIT-69Z-65	\$107.00 ^{KT}
69	Convertible	KIT-69Z-76	\$109.95 ^{KT}
70	Fastback	KIT-70Z-63D	\$116.00 ^{KT}
70	Coupe	KIT-70Z-65D	\$107.00 ^{KT}
70	Convertible	KIT-70Z-76D	\$107.00 ^{KT}
71-73	Fastback, Deluxe	KIT-71Z-63L	\$107.00 ^{KT}

COUPE HEADLINER



Scott Drake now produces some of the best headliners on the market. Formerly available under the Classic Auto Trim label,

our headliners have been preferred by professional installers for years. Manufactured with pride in the U.S. with the most correct fabric available. Precision cut from time tested patterns for a perfect fit. Don't forget new sunvisors to complete the look.

Year	Description	Part No.	List
64-70	Black	HL-FM-CP-65-BK	\$40.95 ^{EA}
64-70	Aqua	HL-FM-CP-65-AQ	\$54.95 ^{EA}
64-70	Med blue	HL-FM-CP-65-BL	\$40.95 ^{EA}
64-70	Dark green	HL-FM-CP-65-DG	\$40.95 ^{EA}
64-70	Dark red	HL-FM-CP-65-DR	\$40.95 ^{EA}
64-70	Med ivy gold	HL-FM-CP-65-IG	\$44.95 ^{EA}
64-70	Light blue	HL-FM-CP-65-LB	\$40.95 ^{EA}
64-70	Maroon	HL-FM-CP-65-MR	\$44.95 ^{EA}
64-70	Parchment	HL-FM-CP-65-PR	\$44.95 ^{EA}
64-70	Red	HL-FM-CP-65-RD	\$40.95 ^{EA}

WE PROUDLY FEATURE AUTHENTIC MUSTANG REPRODUCTIONS FROM SCOTT DRAKE!



Year	Description	Part No.	List
64-70	Saddle	HL-FM-CP-65-SA	\$49 ⁹⁵ EA
64-70	White	HL-FM-CP-65-WT	\$40 ⁹⁵ EA
71-73	Black	HL-FM-CP-71-BK	\$40 ⁹⁵ EA
71-73	Dark blue	HL-FM-CP-71-DB	\$40 ⁹⁵ EA
71-73	Dark red	HL-FM-CP-71-DR	\$40 ⁹⁵ EA
71-73	Ginger	HL-FM-CP-71-GI	\$40 ⁹⁵ EA
71-73	White	HL-FM-CP-71-WT	\$40 ⁹⁵ EA

FASTBACK HEADLINER



Scott Drake now produces some of the best headliners on the market. Formerly available under the Classic Auto Trim label,

our headliners have been preferred by professional installers for years. Manufactured with pride in the U.S. with the most correct fabric available. Precision cut from time tested patterns for a perfect fit. Don't forget new sunvisors to complete the look.

Year	Description	Part No.	List
65-68	Black	HL-FM-FB-65-BK	\$38 ⁹⁵ EA
65-68	Med blue	HL-FM-FB-65-BL	\$38 ⁹⁵ EA
65-68	Dark aqua	HL-FM-FB-65-DA	\$38 ⁹⁵ EA
65-68	Dark green	HL-FM-FB-65-DG	\$38 ⁹⁵ EA
65-68	Dark red	HL-FM-FB-65-DR	\$38 ⁹⁵ EA
65-68	Med ivy gold	HL-FM-FB-65-IG	\$42 ⁵⁰ EA
65-68	Light blue	HL-FM-FB-65-LB	\$38 ⁹⁵ EA
65-68	Med blue	HL-FM-FB-65-MB	\$38 ⁹⁵ EA
65-68	Maroon	HL-FM-FB-65-MR	\$38 ⁹⁵ EA
65-68	Parchment	HL-FM-FB-65-PR	\$38 ⁹⁵ EA
65-68	Bright red	HL-FM-FB-65-RD	\$38 ⁹⁵ EA
65-68	Saddle	HL-FM-FB-65-SA	\$44 ⁹⁵ EA
65-68	Tan	HL-FM-FB-65-TA	\$38 ⁹⁵ EA
65-68	White	HL-FM-FB-65-WT	\$38 ⁹⁵ EA
69-70	Black	HL-FM-FB-69-BK	\$38 ⁹⁵ EA
69-70	Med blue	HL-FM-FB-69-BL	\$38 ⁹⁵ EA
69-70	Dark green	HL-FM-FB-69-DG	\$38 ⁹⁵ EA
69-70	Dark red	HL-FM-FB-69-DR	\$38 ⁹⁵ EA
69-70	Ivy gold	HL-FM-FB-69-IG	\$42 ⁵⁰ EA
69-70	Light blue	HL-FM-FB-69-LB	\$38 ⁹⁵ EA
69-70	Maroon	HL-FM-FB-69-MB	\$38 ⁹⁵ EA
69-70	Red	HL-FM-FB-69-RD	\$38 ⁹⁵ EA
69-70	Saddle	HL-FM-FB-69-SA	\$38 ⁹⁵ EA
69-70	White	HL-FM-FB-69-WT	\$38 ⁹⁵ EA
71-73	Black	HL-FM-FB-71-BK	\$38 ⁹⁵ EA
71-73	Dark blue	HL-FM-FB-71-DB	\$38 ⁹⁵ EA
71-73	Dark green	HL-FM-FB-71-DG	\$38 ⁹⁵ EA
71-73	Ginger	HL-FM-FB-71-GI	\$38 ⁹⁵ EA
71-73	Light blue	HL-FM-FB-71-LB	\$38 ⁹⁵ EA
71-73	Med blue	HL-FM-FB-71-MB	\$38 ⁹⁵ EA
71-73	Maroon	HL-FM-FB-71-MR	\$38 ⁹⁵ EA
71-73	Red	HL-FM-FB-71-RD	\$38 ⁹⁵ EA
71-73	Saddle	HL-FM-FB-71-SA	\$38 ⁹⁵ EA
71-73	White	HL-FM-FB-71-WT	\$38 ⁹⁵ EA

HEADLINER ROD RETAINER



Commonly missing or bent out of shape. A must for correct headliner installation. Attaches to rear bow.

Year	Description	Part No.	List
64-68	Coupe	COAB-6542180-K	\$3 ⁹⁵ PR
69-70	Fastback	C9ZZ-6342180-K	\$4 ⁹⁵ PR

FASTBACK HEADLINER BOWS

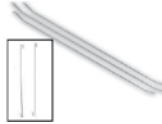

Includes 3 Headliner Bows and one pair of retainers.

Part No.	Year	Description	List
C7Z-6352101-K	67-68	5 pieces	\$49 ⁹⁵ SE

HEADLINER GLUE



This high strength glue comes in an easy to use 4 ounce container with brush applicator built into lid.

Year	Part No.	List
64-73	HLG-1829	\$8 ⁵⁰ EA

HEADLINER INSULATION PAD

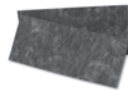

Help insulate interior from both temperature and sound.

Year	Description	Part No.	List
64-68	Coupe	HL-CP-PAD	\$22 ⁹⁵ EA
64-68	Fastback	HL-FB-PAD	\$22 ⁹⁵ EA

HEADLINER ROD RETAINER



Precision die-cut construction black chipboard. Covered with matching headliner material.

Feature steel snap ring for light and clip retainer on back side.

Year	Description	Part No.	List
69-70	Black, moonskin	C9ZZ-63520189BK	\$45 ⁹⁵ PR
69-70	Medium blue, moonskin	C9ZZ-63520189BL	\$45 ⁹⁵ PR
69-70	Dark green, moonskin	C9ZZ-63520189DG	\$45 ⁹⁵ PR
69	Dark red, moonskin	C9ZZ-63520189DR	\$45 ⁹⁵ PR
69-70	Light blue, moonskin	C9ZZ-63520189LB	\$45 ⁹⁵ PR
70	Red, moonskin	C9ZZ-63520189RD	\$45 ⁹⁵ PR
69-70	White, moonskin	C9ZZ-63520189WT	\$45 ⁹⁵ PR
71-73	No cover, panel only	D1ZZ-6352018/9P	\$14 ⁹⁵ PR
71-73	Black, tier grain	D1ZZ-63520189BK	\$45 ⁹⁵ PR
71-73	Blue, tier grain	D1ZZ-63520189BL	\$45 ⁹⁵ PR
71-73	Dark green, tier grain	D1ZZ-63520189DG	\$45 ⁹⁵ PR
71-73	Ginger, tier grain	D1ZZ-63520189GI	\$45 ⁹⁵ PR
71-73	Maroon, tier grain	D1ZZ-63520189MR	\$45 ⁹⁵ PR
71-73	Red, tier grain	D1ZZ-63520189RD	\$45 ⁹⁵ PR
71-73	White, tier grain	D1ZZ-63520189WT	\$45 ⁹⁵ PR

WINDLACE



Snap on vinyl windlace, available in a variety of colors. Sold by the foot.

Fastbacks and coupes require

16 feet, convertibles require 10 feet. **69-73 quarter panel windlace also available in Quarter Panel area of this section.**

Year	Description	Part No.	List
64-70	Black	CSZZ-6502906-BK	\$1 ³⁵ FT
64-70	Aqua	CSZZ-6502906-AQ	\$1 ⁵⁰ FT
64-70	Medium blue	CSZZ-6502906-BL	\$1 ⁵⁰ FT
64-70	Bright red	CSZZ-6502906-BR	\$1 ⁵⁰ FT
64-70	Dark blue	CSZZ-6502906-DB	\$1 ⁵⁰ FT
64-70	Dark red	CSZZ-6502906-DR	\$1 ⁵⁰ FT
64-70	Ivy gold	CSZZ-6502906-IG	\$1 ⁵⁰ FT
64-70	Parchment	CSZZ-6502906-PA	\$1 ⁵⁰ FT
64-70	Saddle	CSZZ-6502906-SA	\$1 ⁵⁰ FT
64-70	White	CSZZ-6502906-WT	\$1 ⁵⁰ FT

CONCOURS WINDLACE



By Scott Drake, an exact copy of previously unavailable Windlace used by Ford in the mid to late

1960's. Only available in black, this PVC Windlace snaps in with ease and features the commonly known "Weave" pattern. Please note Ford used a couple different suppliers of Windlace and their patterns were not identical. Our research found Windlace varied year to year and possibly even month to month depending on vendor supply issues. We also found variances between assembly plants. Please check your original Windlace to make sure this is right for you. Sold by the foot, Fastbacks and Coupes require 16 feet and Convertibles only require 10 feet. For cars that have the Sierra Grain patterned Windlace we have a reproduction that is very similar in appearance and is available under part # C5ZZ-6502906-BK.

Year	Description	Part No.	List
65-68	Black	C5ZZ-6502906BKC	\$1 ⁹⁵ FT

HEADLINER PILLAR TRIM SET



These commonly missing pieces are now available. Painted black. Mounting screws included.

Year	Part No.	List
64-68 Coupe & Fastback	C5ZZ-6552136/7	\$8 ⁹⁵ SE

HEADLINER MOLDING



Finishes off headliner where it meets windshield. Connects to pillar moldings. Fits Coupe and Fastback.

Year	Part No.	List
69-70	C9ZZ-6503606	\$56 ⁹⁵ EA

PILLAR MOLDING



New reproductions of a commonly damaged part. Mounting hardware included. Ready to install.

Year	Description	Part No.	List
69-70	Fastback, black	C9ZZ-6303598/9B	\$119 ⁹⁵ PR
69-70	Fastback, white	C9ZZ-6303598/9W	\$119 ⁹⁵ PR
69-70	Coupe, black	C9ZZ-6503598/9B	\$124 ⁹⁵ PR
69-70	Convertible, black	C9ZZ-7603598/9B	\$124 ⁹⁵ PR
71-73	Fastback, black	D1ZZ-6303598/9B	\$174 ⁹⁵ PR

PILLAR MOLDING



Made from sturdy ABS Plastic this molding allows you to run a pair of gauges on the lefthand pillar. Fastback only.

Year	Description	Part No.	List
69-70	FB, moldings w/ gauges	C9ZZ-6303598/9G	\$104 ⁹⁵ PR

PILLAR POST PAD



Molded in high-grade urethane, these parts are exactly like the originals. Installs with standard door panel clips. **Will not fit Convertible.**

Year	Description	Part No.	List
67-68	Black, RH	C7ZZ-6503598-BK	\$34 ⁹⁵ EA
67-68	Black, LH	C7ZZ-6503599-BK	\$34 ⁹⁵ EA
67-68	Aqua, RH	C7ZZ-6503598-AQ	\$34 ⁹⁵ EA
67-68	Aqua, LH	C7ZZ-6503599-AQ	\$34 ⁹⁵ EA
67-68	Blue, RH	C7ZZ-6503598-BL	\$34 ⁹⁵ EA
67-68	Blue, LH	C7ZZ-6503599-BL	\$34 ⁹⁵ EA
67-68	Ivy gold, RH	C7ZZ-6503598-IG	\$34 ⁹⁵ EA
67-68	Ivy gold, LH	C7ZZ-6503599-IG	\$34 ⁹⁵ EA
67-68	Parchment, RH	C7ZZ-6503598-PR	\$34 ⁹⁵ EA
67-68	Parchment, LH	C7ZZ-6503599-PR	\$34 ⁹⁵ EA
67-68	Red, RH	C7ZZ-6503598-RD	\$34 ⁹⁵ EA
67-68	Red, LH	C7ZZ-6503599-RD	\$34 ⁹⁵ EA

SUNVISORS & MIRROR

COUPE & FASTBACK SUN VISOR



Coupe and Fastback visors are fully padded and covered with the original Moonskin Vinyl on 1964-1970 and with Tier Grain on 1971-1973.

Year	Description	Part No.	List
64-66	Black	C5ZZ-6504104-BK	\$49 ⁹⁵ PR
66	Aqua	C5ZZ-6504104-AQ	\$49 ⁹⁵ PR
64-65	Medium blue	C5ZZ-6504104-BL	\$49 ⁹⁵ PR
64-65	Bright red	C5ZZ-6504104-BR	\$49 ⁹⁵ PR
66	Dark red	C5ZZ-6504104-DR	\$49 ⁹⁵ PR
64-66	Ivy gold	C5ZZ-6504104-IG	\$49 ⁹⁵ PR
66	Light blue	C5ZZ-6504104-LB	\$49 ⁹⁵ PR
64-66	Light green/ivy gold	C5ZZ-6504104-LG	\$49 ⁹⁵ PR
65-66	Parchment	C5ZZ-6504104-PR	\$49 ⁹⁵ PR
66	Turquoise	C5ZZ-6504104-TQ	\$49 ⁹⁵ PR
64-66	White	C5ZZ-6504104-WT	\$49 ⁹⁵ PR
67-68	Black	C7ZZ-6504104-BK	\$49 ⁹⁵ PR
67-68	Aqua	C7ZZ-6504104-AQ	\$49 ⁹⁵ PR
67-68	Dark red	C7ZZ-6504104-DR	\$49 ⁹⁵ PR
67-68	Ivy gold	C7ZZ-6504104-IG	\$49 ⁹⁵ PR
67-68	Light blue	C7ZZ-6504104-LB	\$49 ⁹⁵ PR
67-68	Light green/ivy gold	C7ZZ-6504104-LG	\$49 ⁹⁵ PR
67-68	Parchment	C7ZZ-6504104-PR	\$49 ⁹⁵ PR
67-68	Saddle	C7ZZ-6504104-SA	\$49 ⁹⁵ PR
67-68	White	C7ZZ-6504104-WT	\$49 ⁹⁵ PR
69-70	Black	C9ZZ-6504104-BK	\$49 ⁹⁵ PR
69-70	Medium blue	C9ZZ-6504104-BL	\$49 ⁹⁵ PR
69-70	Dark green	C9ZZ-6504104-DG	\$49 ⁹⁵ PR
69-70	Dark red	C9ZZ-6504104-DR	\$49 ⁹⁵ PR
69-70	Ivy gold	C9ZZ-6504104-IG	\$49 ⁹⁵ PR
69-70	Light blue	C9ZZ-6504104-LB	\$49 ⁹⁵ PR
69-70	Parchment	C9ZZ-6504104-PR	\$49 ⁹⁵ PR
69-70	White	C9ZZ-6504104-WT	\$49 ⁹⁵ PR
71-73	Black	D1ZZ-6504104-BK	\$49 ⁹⁵ PR
71-73	Blue	D1ZZ-6504104-BL	\$49 ⁹⁵ PR
71-73	Dark green	D1ZZ-6504104-DG	\$49 ⁹⁵ PR
71-73	Ginger	D1ZZ-6504104-GI	\$49 ⁹⁵ PR
71-73	Maroon	D1ZZ-6504104-MR	\$49 ⁹⁵ PR
71-73	Red	D1ZZ-6504104-RD	\$49 ⁹⁵ PR
71-73	White	D1ZZ-6504104-WT	\$49 ⁹⁵ PR

CONVERTIBLE SUN VISOR



Convertible visors are covered in the original Sierra Grain vinyl

Year	Description	Part No.	List
65-66	Aqua	C5ZZ-7604104-AQ	\$49 ⁹⁵ PR
64-66	Black	C5ZZ-7604104-BK	\$49 ⁹⁵ PR
64-65	Medium blue	C5ZZ-7604104-BL	\$49 ⁹⁵ PR
64-65	Bright red	C5ZZ-7604104-BR	\$49 ⁹⁵ PR

WE PROUDLY FEATURE AUTHENTIC MUSTANG REPRODUCTIONS FROM SCOTT DRAKE!



Year	Description	Part No.	List
66	Dark red	C5Z-7604104-DR	\$49.95 PR
64-66	Emberglow	C5Z-7604104-EM	\$49.95 PR
64-66	Ivy gold	C5Z-7604104-IG	\$49.95 PR
66	Light blue	C5Z-7604104-LB	\$49.95 PR
64-66	Palomino	C5Z-7604104-PA	\$49.95 PR
66	Parchment	C5Z-7604104-PR	\$49.95 PR
64-66	Turquoise	C5Z-7604104-TQ	\$49.95 PR
64-66	White	C5Z-7604104-WT	\$49.95 PR
67-68	Aqua	C7Z-7604104-AQ	\$49.95 PR
67-68	Black	C7Z-7604104-BK	\$49.95 PR
67-68	Dark blue	C7Z-7604104-DB	\$49.95 PR
67-68	Dark red	C7Z-7604104-DR	\$49.95 PR
67-68	Ivy gold	C7Z-7604104-IG	\$49.95 PR
67-68	Light blue	C7Z-7604104-LB	\$49.95 PR
68	Maroon	C7Z-7604104-MR	\$49.95 PR
68	Nugget gold	C7Z-7604104-NG	\$49.95 PR
67-68	Parchment	C7Z-7604104-PR	\$49.95 PR
67-68	Saddle	C7Z-7604104-SA	\$49.95 PR
67-68	White	C7Z-7604104-WT	\$49.95 PR
69-73	Black	C9Z-7604104-BK	\$49.95 PR
69-73	Blue	C9Z-7604104-BL	\$49.95 PR
69-73	Dark ivy	C9Z-7604104-DI	\$49.95 PR
69-73	Dark red	C9Z-7604104-DR	\$49.95 PR
69-73	Green	C9Z-7604104-GR	\$49.95 PR
69-73	Ivy gold	C9Z-7604104-IG	\$49.95 PR
69-73	Light blue	C9Z-7604104-LB	\$49.95 PR
69-73	Nugget gold	C9Z-7604104-LN	\$49.95 PR
69-73	Parchment	C9Z-7604104-PR	\$49.95 PR
69-73	Vermillion	C9Z-7604104-VE	\$49.95 PR
69-73	White	C9Z-7604104-WT	\$49.95 PR

CENTER SUN VISOR BRACKET



Plastic molded with original looking texture.

Year	Description	Part No.	List
68-73	Conv, black	C8Z-6204132-BK	\$15.95 EA
68-73	Conv, parch / neutral	C8Z-6204132-NE	\$17.95 EA
69-70	Coupe/FB black	C8Z-6204132-NE	\$17.95 EA
69-70	Coupe/FB parch / neutral	C8Z-6204132-NE	\$17.95 EA

SUN VISOR BRACKET & ROD



Set includes brackets with visor pivots and inner rods. These are perfect parts! Coupe/Fastback. For

convertible sun visor brackets & rods, see the "Convertible" category, earlier in this catalog.

Year	Description	Part No.	List
64-66	Chrome	C5Z-6504144-A	\$13.95 EA
67-70	Chrome	C7AZ-6204144-A	\$13.95 EA

SUN VISOR PIN AND TIP



Gray plastic rod with rubber tip. Fits most Ford's from the 70's.

Year	Description	Part No.	List
70-73	Pin and tip	D3AZ-6504114-B	\$3.50 EA

SUN VISOR TIP



Soft rubber tips to go over the ends of the sun visor rods. Original gray color.

Year	Part No.	List
64-73	D1DZ-6204115-A	\$2.50 PR

1964-66 MUSTANG DAY/NIGHT MIRRORS WITH FOMOCO LOGO



Officially Licensed by Ford, Scott Drake's 1964-65 and 1965-66 Mustang Day/Night Mirrors are made as the original with the backside ribbed area painted silver and the FoMoCo logo stamped on back of the mirror housing. Featuring correct Day/Night markings on the knob and show quality chromed steel and glass, this mirror is a must for concours restoration.



Year	Description	Part No.	List
64-65	Push Button Day/Night w/ FoMoCo logo	CSZZ-17700-FMC	\$38.95 EA
65-66	Twist Day/Night w/ FoMoCo logo	C6Z-17700-FMC	\$38.95 EA

REAR VIEW MIRROR

Exact copies, with all the right details. Improved mirror with superior quality crimping of frame to glass.



64-66: Show quality CSZZ-17700-A

List \$18.95 EA

64-65: Day/Night push button. Economy CSZZ-17700-B

List \$28.95 EA



65-66: Day/Night turn button. Economy C6Z-17700-A

List

\$28.95 EA



67: Day/Night C7Z-17700-A

List

\$39.95 EA



68-69: Day/Night, concours C7AZ-17700-G

List

\$53.95 EA



68-70: Day/Night, aftermarket C8AZ-17700-A

List

\$29.95 EA

REAR VIEW MIRROR AND ARM KIT



Save money with this quite attractive new kit. Includes standard mirror and our pressure die cast arm.

Year	Part No.	List
64-66	KIT-MIR-1	\$34.95 KI

REAR VIEW MIRROR MOUNT



Special cast-metal bracket glues to windshield. Plain finish. Exact detail. 68



Year	Part No.	List
68-69	C8AZ-17698-A	\$7.95 EA
70-79	C9AZ-17698-A	\$2.95 EA

REAR VIEW MIRROR ARM

Pressure die cast, with quality chrome. Replaces one of the most visible interior parts.



68-69: Satin C2SZ-17690-F

List

\$15.95 SE



64-66: Concours chrome CSZZ-17690-D

List

\$15.95 EA



67: Concours 2-piece design C7Z-17690-A

List

\$24.95 EA

OVERHEAD COMPONENTS

COAT HOOK

Coat Hooks are a great way to dress up your interior & install with ease.



64-66 Convertible 67 Coupe/
Fastback Chrome
B2A-7029025-A

List

\$9.95^{SE}



64-66: Chrome
C4AZ-6229025-A

List

\$9.95^{SE}



68-73: Black, w/out base
C8AZ-6229024-A

List

\$5.95^{EA}

68-73: Mounting base
C8AZ-6229232

List

\$3.50^{EA}

No Photo Available

Visit www.scottdrake.com
for the most up to date
images and product info

LED DOME LIGHT ASSEMBLY



Kit comes complete with housing, hardware, and modern, smart LED module! This dome light is 5x brighter

and automatically dims after 10 minutes, and turns off after 15 minutes. Lifetime warranty!

Year	Part No.	List
64-70	SD-DOME-LED-WH	\$84.95 ^{EA}

DOME LIGHT ASSEMBLY



We made a bright chrome base with a brighter than original bulb to really improve lighting inside the car. We include

instructions on how to easily add this dome lamp to earlier Mustangs that didn't have this feature. Our dome light assembly can even be mounted up under the back deck to make a great trunk light. Our reproduction dome lens and chrome bezel as well as the mounting hardware and electrical connectors are included to make this a quick and simple project.

Year	Part No.	List
65-70	COAF-13A719-B	\$34.95 ^{KI}

DOMELIGHT HOUSING

Housing is chromed plastic.



COAF-13788-A
67-70

List

\$7.50^{EA}



D6UZ-13788-A
71 Late -73

List

\$24.95^{EA}

DOMELIGHT LENS

High quality injection molded parts, exactly like the originals. Lens is milk white.



67-70
COAF-13783-C

List

\$4.95^{EA}



71-73
D1AZ-13783-B

List

\$10.95^{EA}

COURTESY LIGHT BRACKET



Stamped metal bracket mounts under dash. Socket not included.

Year	Part No.	List
64-69	COAZ-13763-A	\$8.95 ^{EA}

OVERHEAD CONSOLE BRACKET



67-68: Overhead, rear, Fastback
C7ZB-63519B52

List

\$54.95^{EA}



67-68: Overhead, front, Coupe &
Fastback
C7ZB-65519B46-A

List

\$49.95^{EA}

OVERHEAD CONSOLE MAP LIGHT



Die-cast construction with a quality chrome finish. Another excellent reproduction. Includes clear lenses.

Year	Part No.	List
67-68	C7ZZ-13788-A	\$39.95 ^{PR}

OVERHEAD CONSOLE ASSEMBLY

A beautiful reproduction of a rare option. The console base is made of vinyl and urethane with exact details. We have installed our map light switch and light housing with our beautiful chrome bezels. Includes wiring harness and mounting screws. Mounting brackets available separately.



Year	Description	Part No.	List
67	Fastback, black	C7ZZ-63519A58BK	\$399.95 ^{EA}
67	Fastback, blue	C7ZZ-63519A58BL	\$399.95 ^{EA}
67	Fastback, ivy gold	C7ZZ-63519A58IG	\$399.95 ^{EA}
67	Fastback, parchment	C7ZZ-63519A58PR	\$399.95 ^{EA}
67	Fastback, red	C7ZZ-63519A58RD	\$399.95 ^{EA}
67	Coupe, black	C7ZZ-65519A58BK	\$399.95 ^{EA}
67	Coupe, blue	C7ZZ-65519A58BL	\$399.95 ^{EA}
67	Coupe, ivy gold	C7ZZ-65519A58IG	\$399.95 ^{EA}
67	Coupe, parchment	C7ZZ-65519A58PR	\$399.95 ^{EA}
67	Coupe, red	C7ZZ-65519A58RD	\$399.95 ^{EA}

OVERHEAD CONSOLE OVERLAY



Wood grain vinyl for the Overhead Console panel.

Part No.	Year	Description	List
WG-151-V	68	Coupe	\$24.95 ^{EA}
WG-152-V	68	Fastback	\$23.95 ^{EA}

WE PROUDLY FEATURE AUTHENTIC MUSTANG REPRODUCTIONS FROM SCOTT DRAKE!



OVERHEAD CONSOLE PANEL



Features a stamped aluminum, line-grain finish like the originals. Not a cheap vinyl decal.

Part No.	Year	Description	List
C7ZZ-63519A58AL	67	Fastback	\$99.95 EA
C7ZZ-65519A58AL	67	Coupe	\$99.95 EA

CENTER CONSOLE

CRUISER CONSOLE

These consoles are AWESOME! The cruiser console fits perfectly between the front seats and over the gear shifter (manual or auto). Same quality as the original Humphugger plus two large size cup holders. 2 versions available. Both look similar, but SCL- version is designed to fit on top of a factory console. Easily removed for car shows.



Year	Description	Part No.	List
64-73	Black, w/out factory console	CC-BK	\$224.95 EA
64-73	Dark blue, w/out factory console	CC-DB	\$224.95 EA
64-73	Dark red, w/out factory console	CC-DR	\$224.95 EA
64-73	Light blue, w/out factory console	CC-LB	\$224.95 EA
64-73	Bright red, w/out factory console	CC-RD	\$224.95 EA
64-73	Ivy gold, w/out factory console	CC-IG	\$224.95 EA
64-73	Parchment, w/out factory console	CC-PR	\$224.95 EA
64-73	White, w/out factory console	CC-WT	\$224.95 EA
64-67	Black, long, w/ factory console	SCL-BK	\$224.95 EA
64-67	Dark blue, long, w/ factory console	SCL-DB	\$224.95 EA
64-67	Light blue, long, w/ factory console	SCL-LB	\$224.95 EA
64-67	Bright red, long, w/ factory console	SCL-RD	\$224.95 EA
64-67	Dark red, long, w/ factory console	SCL-DR	\$224.95 EA

CONSOLE TOP PLATE



Die cast construction, chrome plated and recessed area painted black.

Year	Description	Part No.	List
64-66		C5ZZ-6504567-C	\$114.95 EA

CONSOLE FLIP OPEN DOOR

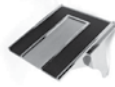

Beautiful chrome and black flip open console door, comes with door springs. Nice reproduction.

Year	Part No.	List
65-66	C5ZZ-6506024-D	\$79.95 EA

HUMP HUGGER CONSOLE



These consoles are designed with quality in mind. All consoles are constructed using automotive grade vinyl and are double stitched with commercial grade nylon thread, resistant to heat and sun. All hinges are corrosion resistant nickel plated for longevity. Designed to sit directly on hump.

Year	Description	Part No.	List
64-73	Black	HH-BK	\$114.95 EA
64-73	Dark blue	HH-DB	\$114.95 EA
64-73	Dark red	HH-DR	\$114.95 EA
64-73	Emberglo	HH-EM	\$114.95 EA
64-73	Ginger	HH-GI	\$114.95 EA
64-73	Ivy gold	HH-IG	\$114.95 EA
64-73	Light blue	HH-LB	\$114.95 EA
64-73	Nugget gold	HH-NG	\$114.95 EA
64-73	Palomino	HH-PA	\$114.95 EA
64-73	Parchment	HH-PR	\$114.95 EA
64-73	Bright red	HH-RD	\$114.95 EA
64-73	Saddle	HH-SA	\$114.95 EA
64-73	Turquoise	HH-TQ	\$114.95 EA
64-73	White	HH-WT	\$114.95 EA

PLUG & CHUG CONSOLE



The 64-66 Plug & Chug inserts into the dash in place of an ashtray. The 68-73 Plug & Chug goes into the seat belt holder of the center console.

Year	Description	Part No.	List
64-66	Black	PC-BK	\$41.95 EA
68-69	Black	PC-BK-68	\$41.95 EA
71-73	Black	PC-BK-71	\$41.95 EA
64-66	White	PC-WT	\$41.95 EA

CONSOLE HOUSING



A beautiful reproduction. Ready for your lights and panels. Back side conveniently marked for trimming on convertible & AC applications. Look for complete assembled consoles in early 2016.

Year	Description	Part No.	List
64-66	Black	C5ZZ-5045A36-A	\$229.95 EA
64-66	White	C5ZZ-65045A36-W	\$239.95 EA

CONSOLE DOOR SPRING

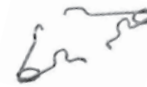

Correct springs for console doors. Plated to prevent corrosion.

Year	Part No.	List
64-66	C5ZZ-6506040/1A	\$8.95 PR

SADDLE CONSOLE



Designed to fit over the top of 1964-1967 consoles. All consoles are constructed using automotive grade vinyl and are double stitched with commercial grade nylon thread, resistant to heat and sun. All hinges are corrosion resistant nickel plated for longevity.

Year	Description	Part No.	List
64-67	Black	SC-BK	\$114.95 EA
64-67	Dark blue	SC-DB	\$114.95 EA
66-67	Dark red	SC-DR	\$114.95 EA
64-66	Emberglo	SC-EM	\$114.95 EA
66-67	Ivy gold	SC-IG	\$114.95 EA
66-67	Light blue	SC-LB	\$114.95 EA
64-65	Palomino	SC-PA	\$114.95 EA
66-67	Parchment	SC-PR	\$114.95 EA
64-65	Bright red	SC-RD	\$114.95 EA
66-67	Turquoise	SC-TQ	\$114.95 EA
64-66	White	SC-WT	\$114.95 EA

CONSOLE FRONT PANEL



The front panel for the glovebox in the console.

Year	Part No.	List
65-66	C5ZZ-6306021	\$14.95 EA

CONSOLE END CAP



Pressure die cast zinc with show car quality chrome. Used on air conditioned cars only.

Year	Description	Part No.	List
64-65		C5ZZ-65044D38-A	\$49.95 ^{EA}
66		C6ZZ-65044D38-A	\$77.95 ^{EA}

CONSOLE ASH TRAY RECEPTICLE



A beautiful reproduction of the ash tray that fits in the back of the center console.

Year	Part No.	List
64-66	C5ZZ-65048A42-A	\$41.95 ^{EA}

CONSOLE REAR LIGHT ASSEMBLY



Good quality reproduction part, features white plastic lens and pressure die cast body with excellent chrome on the bezel.

Year	Part No.	List
64-66	C5ZZ-13707-A	\$49.95 ^{EA}
67-68	C7ZZ-13707-A	\$49.95 ^{EA}

CONSOLE LAMP LENS



Fits on the rear of the console. Original white plastic color.

Year	Part No.	List
64-66	C5ZZ-13734-A	\$5.95 ^{EA}
67-68	C7ZZ-13783-A	\$6.95 ^{EA}

CONSOLE HARNESS FEED



This harness supplies power to the console. Comes from under dash harness and runs underneath carpet, exits at carpet shifter hole location.

Year	Description	Part No.	List
64-66	Dash to console	C5ZZ-13B712-A	\$28.95 ^{EA}
69	Dash to console	C9ZZ-13B712-A	\$34.95 ^{EA}
68	Shelby, dash to console	S8MS-13B712-A	\$34.95 ^{EA}

CONSOLE INTERIOR HARNESS



This harness plugs into console harness feed. Operates rear courtesy lights and front storage compartment on non AC cars.

Year	Description	Part No.	List
64-66	W/out AC	C5ZZ-13B711-LG	\$19.95 ^{EA}
64-66	W/ AC	C5ZZ-13B711-SM	\$15.95 ^{EA}

CONSOLE MOUNTING BRACKET

Stamped steel design painted black, made exactly as original. Mounting hardware included.



64-66: Front
C5ZZ-65045B32

List
\$11.95^{EA}

CONSOLE RESTORATION KIT



Makes restoring a console easy and convenient. Kit includes shift dial, shift slide, console lens with screws and all hardware necessary to mount console to the floor.

Year	Part No.	List
64-66	KIT-TRN-3	\$19.95 ^{KIT}

CONSOLE MOUNTING KIT



Very convenient kit to easily mount your console. Includes all correct screws needed.

Year	Description	Part No.	List
64-66	16 pcs.	CMK-656	\$5.50 ^{KIT}

CONSOLE SHIFT PLATE

Nice reproductions. See Interior Transmission, later in this section, for related parts.



64-66: Automatic trans, chrome/black
C5ZZ-7C309-A

List
\$69.95^{EA}



64-66: Manual trans
C5ZZ-7C309-M

List
\$69.95^{EA}



67-68: Automatic trans, chrome
C7ZZ-7C309-A

List
\$124.95^{EA}

CONSOLE SHIFT PLATE (CONTINUED)



67-68: Manual trans, chrome
C7ZZ-7C309-M

List

\$149.95^{EA}



67-68: Automatic trans, brushed aluminum

List

\$14.95^{EA}

COMPLETE CONSOLE ASSEMBLY



This complete console assembly for 64-66 Mustangs features a full length paintable black ABS plastic housing with

all appropriate chrome die cast trim installed as well as ash tray, rear courtesy lamp, wire harness, shifter bezel and shifter boot (manual transmission), shifter plate assembly (automatic transmission). Console comes fully assembled and ready to install. Convertibles must trim bottom side of console to clear floor reinforcement, this is clearly marked on the backside to eliminate guess work. Mounting hardware available under part number CMK-656 and C5ZZ-65045B32 front mounting bracket will be required for cars that originally did not have a console..

Year	Description	Part No.	List
64-66	Automatic console assembly (black)	C5ZZ-6504536-AK	\$649.95 ^{KIT}
64-66	Manual console assembly (black)	C5ZZ-6504536-MK	\$639.95 ^{KIT}

COMPLETE CONSOLE ASSEMBLY



Wow! What a nice part, never thought a reproduction would ever be made. Plastic injection black housing just as original, not a substandard fiberglass version. Includes: Radio bezel, all upper brushed chrome plates, ash tray, floor convenience lamp and wiring harness.

Year	Description	Part No.	List
67-68	67: Automatic Will also fit 68, but not concurs for 68	C7ZZ-65045A36-K	\$1,019.95 ^{EA}
67-68	67: Manual, Will fit 1968, but not concurs correct	C7ZZ-65045A36-M	\$1,019.95 ^{EA}

WE PROUDLY FEATURE AUTHENTIC MUSTANG REPRODUCTIONS FROM SCOTT DRAKE!



CONSOLE ROLL UP DOOR



Stainless steel flexible slats just like original, chrome plated knob.

Year	Description	Part No.	List
67		C7ZZ-6506024-A	\$34 ⁹⁵ EA
68		C8ZZ-6506024-A	\$34 ⁹⁵ EA

69-70 CONSOLE ASSEMBLY



This beautiful reproduction includes main housing, both ash trays, cigarette lighter assembly, main top plate, compartment box and armrest pad hinge.

Arm rest pad and console shift plate are sold separately.

Year	Description	Part No.	List
69-70		C9ZZ-6504536	\$419 ⁹⁵ EA

CONSOLE INSERT



These are complete inserts for our Deluxe Console Plates. Plastic chrome with wood-grain vinyl, ready to install!

wood-grain vinyl, ready to install!

Year	Description	Part No.	List
69	Teak	C9ZZ-6504567-CT	\$42 ⁵⁰ EA
69	Walnut	C9ZZ-6504567-CW	\$42 ⁵⁰ EA
70	Teak	D0ZZ-6504567-CT	\$42 ⁵⁰ EA
70	Walnut	D0ZZ-6504567-CW	\$42 ⁵⁰ EA

CONSOLE SHIFT PLATE



Year	Description	Part No.	List
69	Deluxe, auto-matic trans	C9ZZ-6504567-AD	\$94 ⁹⁵ EA
69	Standard, automatic trans	C9ZZ-6504567-AS	\$120 ⁹⁵ EA
69	Deluxe, 4 speed	C9ZZ-6504567-MD	\$120 ⁹⁵ EA
69	Standard, 4 speed	C9ZZ-6504567-MS	\$146 ⁹⁵ EA
70	Deluxe, auto-matic trans	D0ZZ-6504567-AD	\$94 ⁹⁵ EA
70	Standard, automatic trans	D0ZZ-6504567-AS	\$120 ⁹⁵ EA
70	Deluxe, 4 speed	D0ZZ-6504567-MD	\$120 ⁹⁵ EA
70	Standard, 4 speed	D0ZZ-6504567-MS	\$146 ⁹⁵ EA

CONSOLE HOUSING



69-70: Upper housing, Shelby
C9ZZ-63044D90-A

List
\$450 ⁰⁰ EA



71-73: Finish plate
D1ZZ-7C309-A/M

List
\$154 ⁹⁵ EA

CONSOLE UPPER PLATE



This is the upper panel that the shifter plate attaches to, comes with the metal retainers.

Year	Part No.	List
69-70	C9ZZ-6304490	\$119 ⁹⁵ EA

CONSOLE ASH TRAY LID



Our lid makes replacing those broken lids easy. Features correct texture and color.

Year	Part No.	List
69-70	C9ZZ-6504814	\$57 ⁵⁰ EA

CONSOLE COMPARTMENT BOX



This is the compartment box, it includes the chrome trim for cigar lighter.

Year	Part No.	List
69	C9ZZ-6506010	\$84 ⁹⁵ EA

CONSOLE PAD

Correct urethane molded and textured black vinyl pad. Easy to replace those cracked and worn originals.



69-70: Standard
C9ZZ-6506024-BK

List
\$39 ⁹⁵ EA



70: Deluxe
D0ZZ-6506024-BK

List
\$44 ⁹⁵ EA



71-73: Black only
D1ZZ-6506024-A

List
\$64 ⁹⁵ EA

CONSOLE PAD HINGE



Year	Part No.	List
69-70	C9ZZ-6306050	\$19 ⁹⁵ EA

CONSOLE OVERLAY



Year	Description	Part No.	List
64-66	Wood vinyl decal, auto. trans	CSZZ-6504567-W	\$17 ⁹⁵ SE
64-66	Metal backed wood, man. trans	CSZZ-6504567-MT	\$99 ⁹⁵ SE
64-66	Metal backed wood, auto. trans	CSZZ-6504567-AT	\$99 ⁹⁵ SE
67	Aluminum mylar, auto. trans	C7ZZ-6504567-A	\$64 ⁹⁵ SE
69	Wood vinyl, w/ seat belts	WG-153-V	\$16 ⁹⁵ EA
69-70	Wood vinyl, w/out seat belts	WG-154-V	\$16 ⁹⁵ EA

TRANSMISSION

SHIFTER ASSEMBLY



This is a complete shifter including the reverse lock out mechanism. Great chrome and sturdy construction.

Year	Description	Part No.	List
67-68	Console cars only	C7ZZ-7210-KIT	\$189 ⁹⁵ EA

AUTOMATIC SHIFTER SELECTOR

LEVER



Complete assembled shift lever ready to install.

Year	Description	Part No.	List
64-68	64-66: All 67-68: w/out console	CSZZ-7210-A	\$84 ⁹⁵ EA
69-73	69-73: All	C9ZZ-7210-A	\$84 ⁹⁵ EA

AUTOMATIC SHIFTER HANDLE



Pressure die-cast and triple chrome plated. Black plastic buttons and set screws are included.

Year	Description	Part No.	List
64-73	65-68 Concours, Will also fit 69-73	C5ZZ-7213-F	\$18. ⁰⁰



Year	Description	Part No.	List
69-73	Concours	C90Z-7213-B	\$24. ⁹⁵ SE

AUTOMATIC VR™ SHIFTER HANDLE



Add custom high performance styling with the new Scott Drake VR™ automatic shifter handle. This precision die

cast handle features exclusive V-rated rubber tire tread grips and a slightly larger than stock shape for a more comfortable feel and precise shifter control. Each unit is polished and chrome plated for years of lasting good looks. Original black plastic push buttons are included.

Year	Description	Part No.	List
64-73	AutoShift Handle w/Tire Tread Grip	C5ZZ-7213-TT	\$39. ⁹⁵ EA

DELUXE AUTOMATIC SHIFTER HANDLE



Deluxe and Mach 1 interior had this upgrade shifter handle. Exclusively available from Scott Drake.

Year	Description	Part No.	List
67-73	Black, deluxe	C80Z-7213-BK	\$59. ⁹⁵ EA
67-73	Black, leather, deluxe	C80Z-7213-BKL	\$59. ⁹⁵ EA
67-69	Dark blue, deluxe	C80Z-7213-BL	\$64. ⁹⁵ EA
68-69	Maroon, deluxe	C80Z-7213-MR	\$64. ⁹⁵ EA
67-68	Parchment, deluxe	C80Z-7213-PR	\$64. ⁹⁵ EA
67-68	Saddle, deluxe	C80Z-7213-SA	\$64. ⁹⁵ EA

SHIFTER BUTTONS



Year	Description	Part No.	List
64-68	Black	C5ZZ-7C488-C	\$5. ⁹⁵ PR
68-71	Chrome plated, LH	C80Z-7C488-A	\$28. ⁹⁵ EA
69-73	Black	C9ZZ-7C488-C	\$6. ⁹⁵ SE

SHIFTER COVER ASSEMBLY

Quality chrome finish over zinc die cast. Features correct details and paint. Seal & Dial included.



64: Concours, w/out arrows
C4ZZ-7D394

List
\$39. ⁹⁵ EA



65-66: Concours
C5ZZ-7D394

List
\$39. ⁹⁵ EA



67-68: Not exact copy
C7ZZ-7D394

List
\$39. ⁹⁵ EA



67-68: Concours
C7ZZ-7D394-P

List
\$44. ⁹⁵ EA



69-70: Concours, will also fit 1971-73 for an upgraded look
C9ZZ-7D394

List
\$69. ⁹⁵ EA



71: Black plastic original. *Switching to chrome C9ZZ-7D394 is a common upgrade.
D1ZZ-7D443-A

List
\$62. ⁵⁰ EA

SHIFTER DIAL



Precision molded clear plastic with black or clear background under red arrows and white letters.

Year	Description	Part No.	List
64	Early 64, Black, No arrows, non-console	C4ZZ-7A213-A	\$9. ⁹⁵ EA
65-66	Black, non-console	C5ZZ-7A213-A	\$9. ⁹⁵ EA
64-66	Black, for center console	C5ZZ-7A213-D	\$12. ⁰⁰ EA
67-68	Black, non-console	C7ZZ-7A213-A	\$9. ⁹⁵ EA
69-70	Clear, no arrows, All	C9ZZ-7E271-A	\$12. ⁰⁰ EA

SHIFT INDICATOR LIGHT



A nice reproduction. Features a bright zinc finish for long life. Ford type connectors for quick installation.

Part No.	Year	Description	List
C5ZZ-15A808-A	65-66	All	\$52. ⁹⁵ EA
C7ZZ-15A808-A	67-68	W/out console	\$52. ⁹⁵ EA

SHIFT INDICATOR LIGHT



A nice reproduction. Features a bright zinc finish for long life. Ford type connectors for quick installation.

Part No.	Year	Description	List
C5ZZ-15A808-A	65-66	All	\$52. ⁹⁵ EA
C7ZZ-15A808-A	67-68	W/out console	\$52. ⁹⁵ EA

CONSOLE SHIFT INDICATOR LIGHT



A nice reproduction.

Year	Description	Part No.	List
67-68	W/ console	C7ZZ-15A808-B	\$52. ⁹⁵ EA

AUTOMATIC SHIFTER INDICATOR



Year	Part No.	List
69-73	C9ZZ-7A110-A	\$8. ⁹⁵ EA

SHIFTER BEZEL AND KNOB KIT



Includes shift knob, bezel, new bushings and mounting hardware. Without factory console.

Year	Part No.	List
64-66	KIT-TRN-1	\$59. ⁹⁵ KI
67-68	KIT-TRN-2	\$59. ⁹⁵ KI

CONSOLE SHIFTER SELECTOR ROD



This is the rod that connects the shifter to the indicator in the console for automatic transmissions.

Year	Part No.	List
67-68	C7ZZ-7E148-A	\$14. ⁹⁵ EA

CONSOLE SHIFT SIDE SEAL



Die cut from a tough, wear resistant material which matches the original. Automatic transmissions only.

Year	Part No.	List
64-66	C5ZZ-7C445-A	\$2. ⁵⁰ EA
67-68	C7ZZ-7C445-A	\$2. ⁵⁰ EA

WE PROUDLY FEATURE AUTHENTIC MUSTANG REPRODUCTIONS FROM SCOTT DRAKE!



AUTOMATIC SHIFT PLATE ASSEMBLY



Precision stamped steel construction, painted black, includes shift dial, selector slide and proper hardware.

Year	Description	Part No.	List
65-66	w/ console	C5ZZ-7D350-K	\$39. ⁹⁵ KI

MANUAL SHIFTER LEVER



Factory detailing and triple chrome plating distinguish our tubular shift handles from the rest. Cable and T-lever included. American made for quality workmanship.

Part No.	Year	Description	List
C5ZZ-7210-M	65-67	4-speed	\$169. ⁹⁵ EA
C5ZZ-7210-T	65-67	5-speed	\$144. ⁹⁵ EA
C8ZZ-7210-A	68	4-speed	\$169. ⁹⁵ EA

SHIFT BOOT RETAINER

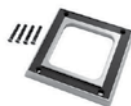

These pieces really dress up the area around the shifter.

Part No.	Year	Description	List
C4ZB-7262-B	64-68	Chrome, Deluxe, 3 and 4 speed, w/ out console. Rare Original Option	\$34. ⁹⁵ EA
C4ZB-7262-S	64-68	Satin, Deluxe, 3 and 4 speed, w/ out console	\$34. ⁹⁵ EA



C5ZZ-7262-C
64-68: Chrome, manual trans w/ out console

List
\$10.⁹⁵ EA



C9ZZ-7262-C
69-70: Chrome, manual trans

List
\$27.⁹⁵ EA

RUBBER SHIFTER BOOT

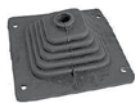

An exact copy of the original. Compression molded E.P.D.M. rubber. Features a textured skin that matches the original appearance exactly. Ours has a steel insert just like the originals.

Year	Description	Part No.	List
64-68	3 and 4 speed	C5ZZ-7277-B	\$9. ⁹⁵ EA
69-70	3 and 4 speed	C9ZZ-7277-A	\$20. ⁹⁵ EA
70	Hurst, 4 speed	DOZZ-7277-B	\$22. ⁹⁵ EA

GENUINE LEATHER SHIFTER BOOT



These leather shift boots look great! Our 64-73 boots feature draw string at the neck and rubber insulated metal mounting plate.

Year	Description	Part No.	List
64-68	Leather w/ draw string	C5ZZ-7277-L	\$32. ⁵⁰ EA
69-73	Leather w/ draw string	C9ZZ-7277-L	\$32. ⁵⁰ EA

LOWER SHIFTER BOOT



This rubber boot mounts on the shifter housing underneath the shift boot. Most cars are missing this important part. It was designed to keep dirt and moisture out of the shifter box and reduce noise coming through the shifter hole. An excellent reproduction.

Year	Description	Part No.	List
65-68	3 speed	C6ZZ-7138-B	\$27. ⁹⁵ EA
65-68	4 speed	C6ZZ-7138-C	\$27. ⁹⁵ EA
69	4 speed	C9ZZ-7138-B	\$47. ⁹⁵ EA
70	4 speed Hurst	DOGZ-7138	\$52. ⁹⁵ EA

ORIGINAL CLUTCH PEDALS



Exact reproductions of the originals. Made in the U.S.A. See "Transmission" section for more related parts.

Year	Description	Part No.	List
65-66	6 cyl and V8	C6ZZ-7519-A	\$138. ⁹⁵ EA
67-68	6 cyl and V8, Requires minor modification for 68	C7ZZ-7519-A	\$139. ⁹⁵ EA

AFTERMARKET CLUTCH PEDAL



These clutch pedals feature an improved design (removable pin) for easier installation. Compatible with existing hanger assembly even in automatics.

Year	Description	Part No.	List
65-66	W/ removable pin	C6ZZ-7519-AR	\$174. ⁹⁵ EA
67-68	W/ removable pin	C7ZZ-7519-AR	\$174. ⁹⁵ EA
69-70	W/ removable pin	C9ZZ-7519-B	\$174. ⁹⁵ EA
71-73	W/ removable pin	D1ZZ-7519-B	\$179. ⁹⁵ EA

CLUTCH PEDAL BUMPER

This rubber bumper installs into the clutch pedal. Helps prevent "clunk" when pedal returns back, and properly aligns clutch pedal height.



67-68
C7ZZ-7583

List
\$3.²⁵ EA



69-70
DOZZ-7583

List
\$3.²⁵ EA

CLUTCH PEDAL STOP



Good copy of original, fabric web cushion.

Year	Part No.	List
64-66	C2OZ-7A630-A	\$25. ⁹⁵ EA

PEDALS, PADS AND TRIM

CLUTCH PEDAL PAD



These reproduction pads are high quality replacements for worn or missing original pads.

Year	Part No.	List
65-68	C5ZZ-7A624-B	\$4. ⁹⁵ EA
69-73	C9ZZ-7A624-A	\$8. ⁹⁵ EA

CLUTCH PEDAL PAD TRIM



Replacement clutch pedal pad trim. Stainless steel construction.

Year	Part No.	List
65-68	C5ZZ-7B544-A	\$8. ⁹⁵ EA
69-73	C9ZZ-7B544-A	\$12. ⁹⁵ EA

BRAKE AND CLUTCH PEDAL PAD



Sold as a matching set for the clutch and brake pedals for manual transmission cars. High quality EPDM rubber will look great for years. Great addition for those with a 302 or have done a 5.0 swap!

Year	Description	Part No.	List
65-68	5.0	CSZZ-2457624-50	\$19.95 ^{PR}

BRAKE PEDAL PAD



Made by Scott Drake with exact detail of the original. Compression molded rubber. Disc brake versions include stainless steel center trim.

Year	Description	Part No.	List
64-67	W/power drum brakes	CSZZ-2457-E	\$12.95 ^{EA}
64-67	Drum brakes. automatic trans	CSZZ-2457-F	\$6.95 ^{EA}
65-73	Drum brakes. manual trans	CSZZ-2457-G	\$4.95 ^{EA}
68-73	Drum brakes. automatic trans	C60Z-2457-A	\$6.95 ^{EA}

DISC BRAKE PEDAL PAD



Made by Scott Drake with exact detail of the original. Compression molded rubber. Disc brake versions include stainless steel center trim.

Year	Description	Part No.	List
65-67	Disc brakes. automatic trans	CSZZ-2454-C	\$10.95 ^{EA}
64-73	Disc brakes. manual trans	CSZZ-2454-D	\$9.95 ^{EA}
68-73	Disc brakes. automatic trans	D3ZZ-2454-A	\$12.95 ^{EA}

BRAKE PEDAL PAD TRIM



Replacement brake pedal pad trim.

Year	Description	Part No.	List
65-67	Auto trans	CSZZ-2A487-B	\$8.50 ^{EA}
68-73	Auto trans	C60Z-2A487-A	\$10.95 ^{EA}
65-73	Man trans	D1ZZ-2A487-B	\$11.95 ^{EA}

POWER BRAKE PEDAL



This pedal required when switching over to factory power brakes. This pedal is not required when using our power brake conversions. *Note: will*

fit 1967 but must use 1968 Brake Pad. Will fit 1970 but must use 67-69 Factory Brake Booster.

Year	Description	Part No.	List
68-69	Automatic trans	DBC-A21184	\$94.95 ^{EA}
68-69	Manual trans	DBC-A21185	\$104.95 ^{EA}

PARKING BRAKE PEDAL PAD

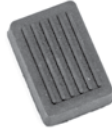

Made by Scott Drake, this Parking Brake Pad is an exact copy of the original. Molded from wear resistant rubber for years of use.

Year	Description	Part No.	List
69-73	Note: will NOT fit 1970 Mustang or Cougar	C9ZZ-2454-A	\$5.95 ^{EA}

PARKING BRAKE PEDAL PAD TRIM



Made from stainless steel, just like the originals.

Year	Description	Part No.	List
69-73	Note: will NOT fit 1970 Mustang or Cougar	C9ZZ-2A487-C	\$9.95 ^{EA}

PARKING BRAKE HANDLE

High quality injection molded parts, mounting lock pin and allen set screw included. Excellent detail in a reproduction part. Black with white "Brake" lettering (1964 - 1966) on ribbed face of handle. Later handles (1967 - 1968) are all black. New improved metal insert. Thicker than original. Includes original drive pin as well as an allen head socket set screw to allow easy removal and installation in the future.



64-66
CODZ-2760-B

List

\$7.95^{EA}



67-68
C7ZZ-2760-B

List

\$7.95^{EA}

BILLET PARKING BRAKE HANDLE



Machined from solid billet aluminum. This handle is highly durable while adding a touch of class to your interior. *A perfect compliment to our new Billet Pedals (See Interior Section).*

Year	Description	Part No.	List
64-68	Billet	B-2760-BL	\$39.95 ^{EA}

ACCELERATOR PEDAL



These steel reinforced parts are molded from high quality rubber for a long life and great appearance. See "Fuel" section for many related parts.

Year	Description	Part No.	List
64-68	W/ stainless trim	CSZZ-9735-D	\$9.95 ^{EA}
69-70	W/out trim	C9ZZ-9735-D	\$14.95 ^{EA}
71-73	W/out trim	D1ZZ-9735	\$16.50 ^{EA}

ACCELERATOR PEDAL MOUNTING

SCREW



A precision machined screw with exact detail. Painted black.

Year	Part No.	List
64-68	380503-5101	\$2.95 ^{EA}
69-70	C80Z-9873	\$5.50 ^{EA}

ACCELERATOR PEDAL SPRING



Made of strong spring steel for a long life.

Year	Description	Part No.	List
64-68	Spring steel	CSZZ-9760-B	\$2.95 ^{EA}
69-70	Spring steel	C90Z-9760	\$3.95 ^{EA}

WASHER PUMP PEDAL PAD



Great reproduction of the original, with crisp detailing in the rubber.

Year	Part No.	List
67-68	C7ZZ-17664-P	\$2.75 ^{EA}

WE PROUDLY FEATURE AUTHENTIC MUSTANG REPRODUCTIONS FROM SCOTT DRAKE!



BILLET PEDAL COVER



Machined from solid 6061-T6 billet aluminum with a clear anodized finish, these pedal covers are a great

addition to any vehicle. Includes stainless steel mounting hardware. Features aggressive tread design to prevent your feet from slipping off the pedals!

Year	Description	Part No.	List
64-67	Brake pedal, automatic	CSZZ-2457-FBL	\$24.95 ^{EA}
68-73	Brake pedal, automatic	C60Z-2457-ABL	\$24.95 ^{EA}
64-68	Brake pedal, manual	CSZZ-2457-GBL	\$19.95 ^{EA}
64-68	Clutch pedal	CSZZ-7A624-BBL	\$19.95 ^{EA}



Year	Description	Part No.	List
64-68	Accelerator pedal	CSZZ-9732-DBL	\$34.95 ^{EA}

BILLET DIMMER SWITCH COVER



By Scott Drake is the beautifully machined and anodized billet Dimmer Switch Cover. Crafted with our exclusive tread pattern to match our fine line of billet pedal covers, this Switch cover will fit 1965-73

Mustangs as well as 1966-77 Broncos.

Year	Part No.	List
64-73	CSZZ-13533-BL	\$19.95 ^{EA}

TMI STANDARD DOOR PANEL



1964-68 STD DOOR PANEL (TMI)

Year	Description	Part No.	List
64-65	Black	CSZZ-65239423TK	\$79.95 ^{PR}
64-65	Special Order Colors	CSZZ-65239423SOT	\$79.95 ^{PR}
66	Black	C6ZZ-65239423TK	\$79.95 ^{PR}
66	Special Order Colors	C6ZZ-65239423SOT	\$79.95 ^{PR}
67	Black	C7ZZ-65239423TK	\$79.95 ^{PR}
67	Special Order Colors	C7ZZ-65239423SOT	\$79.95 ^{PR}
68	Black	C8ZZ-65239423TK	\$79.95 ^{PR}
68	Special Order Colors	C8ZZ-65239423SOT	\$79.95 ^{PR}

1969 STD DOOR PANEL (TMI)

Year	Description	Part No.	List
69	Black	C9ZZ-65239423TK	\$84.95 ^{PR}
69	Special Order Colors	C9ZZ-65239423SOT	\$84.95 ^{PR}

1970 STD DOOR PANEL (TMI)

Year	Description	Part No.	List
70	Black	DOZZ-65239423TK	\$119.95 ^{PR}
70	Special Order Colors	DOZZ-65239423SOT	\$119.95 ^{PR}

1971-73 STD DOOR PANEL (TMI)

Year	Description	Part No.	List
71-73	Black	D1ZZ-65239423TK	\$124.95 ^{PR}
71-73	Special Order Colors	D1ZZ-65239423SOT	\$124.95 ^{PR}

TMI DELUXE DOOR PANEL



1964-66 DELUXE DOOR PANEL (TMI)

Year	Description	Part No.	List
64-66*	Black	CSZZ65239423BKT	\$209.95 ^{PR}
64-66*	White	CSZZ65239423WTT	\$209.95 ^{PR}
64-66*	Special Order Colors	CSZZ65239423SOT	\$209.95 ^{PR}

*Stainless steel trim not included.

1967 DELUXE DOOR PANEL (TMI)

Year	Description	Part No.	List
67*	Black	C7ZZ65239423BKT	\$219.95 ^{PR}
67*	Special Order Colors	C7ZZ65239423SOT	\$219.95 ^{PR}

*Stainless steel trim not included.

1968 DELUXE DOOR PANEL (TMI)

Year	Description	Part No.	List
68*	Black	C8ZZ65239423BKT	\$174.95 ^{PR}
68*	Special Order Colors	C8ZZ65239423SOT	\$174.95 ^{PR}

TMI MACH 1 DELUXE DOOR PANEL



New precision molds - authentic look and fit includes these features:
Bottom carpet, inner

beltline weatherstrips & lock grommets. Bright trim, lights & wood grain panels not included.



1969-70 MACH 1 DELUXE (TMI)

Year	Description	Part No.	List
69	Black w/Black Carpet	C9ZZ65239423BKT	\$424.95 ^{PR}
69	White w/Black Carpet	C9ZZ65239423WTT	\$424.95 ^{PR}
69	Special Order Colors	C9ZZ65239423SOT	\$424.95 ^{PR}
70	Black w/Black Carpet	DOZZ65239423BKT	\$424.95 ^{PR}
70	White w/Black Carpet	DOZZ65239423WTT	\$424.95 ^{PR}
70	Special Order Colors	DOZZ65239423SOT	\$424.95 ^{PR}

1971-73 MACH 1 DELUXE (TMI)

Year	Description	Part No.	List
71-73	Black w/Black Carpet	D1ZZ65239423BKT	\$434.95 ^{PR}
71-73	White w/Black Carpet	D1ZZ65239423WTT	\$434.95 ^{PR}

TMI 2-TONE STD DOOR PANEL



1964-68 2 TONE STANDARD (TMI)

Year	Description	Part No.	List
64-66	Special Order Colors	CSZZ-65239423TT	\$109.95 ^{PR}
67-68	Special Order Colors	C7ZZ-65239423TT	\$109.95 ^{PR}

TMI 2-TONE PONY DOOR PANEL

2 TONE PONY DOOR PANEL (TMI)

Year	Description	Part No.	List
64-65	Special Order Colors	CSZZ-65239423TT	\$174.95 ^{PR}

1964-66 ARM REST PADS

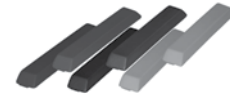

1964-66 ARM REST PADS (TMI)

Year	Description	Part No.	List
64-66	Black	CSZZ-6524100-BK	\$10.95 ^{EA}
64-65	Bright Red	CSZZ-6524100-BRT	\$10.95 ^{EA}
66	Dark Red	CSZZ-6524100-DRT	\$10.95 ^{EA}
64-66	Off White	CSZZ-6524100-WTT	\$10.95 ^{EA}
66	Parchment	CSZZ-6524100-PRT	\$10.95 ^{EA}
66	Palomino	CSZZ-6524100-PAT	\$10.95 ^{EA}
66	Aqua/Turquoise	CSZZ-6524100-AQT	\$10.95 ^{EA}
66	Light Blue	CSZZ-6524100-LBT	\$10.95 ^{EA}
64-65	Ivy Gold	CSZZ-6524100-IGT	\$10.95 ^{EA}
64-65	Medium Blue	CSZZ-6524100-BLT	\$10.95 ^{EA}
66	Dark Blue	CSZZ-6524100-DBT	\$10.95 ^{EA}

TMI SUN VISORS



1964-73 CPE/FSTBK SUN VISOR (TMI)

Year	Description	Part No.	List
64-66	Black	C5ZZ-6504104BKT	\$50 ^{.95} PR
64-66	Special Order Colors	C5ZZ-6504104SOT	\$50 ^{.95} PR
67-68	Black	C7ZZ-6504104BKT	\$50 ^{.95} PR
67-68	Special Order Colors	C7ZZ-6504104SOT	\$50 ^{.95} PR
69-70	Black	C9ZZ-6504104BK	\$50 ^{.95} PR
69-70	Special Order Colors	C9ZZ-6504104SOT	\$50 ^{.95} PR
71-73	Black	D1ZZ-6504104BKT	\$50 ^{.95} PR
71-73	Special Order Colors	D1ZZ-6504104SOT	\$50 ^{.95} PR

1964-73 CONVERTIBLE SUN VISOR (TMI)

Year	Description	Part No.	List
64-66	Black	C5ZZ-7604104BKT	\$50 ^{.95} PR
64-66	Special Order Colors	C5ZZ-7604104SOT	\$50 ^{.95} PR
67-68	Black	C7ZZ-7604101BKT	\$50 ^{.95} PR
67-68	Special Order Colors	C7ZZ-7604104SOT	\$50 ^{.95} PR
69-70	Black	C9ZZ-7604104BKT	\$50 ^{.95} PR
69-70	Special Order Colors	C9ZZ-7604104SOT	\$50 ^{.95} PR
71-73	Black	D1ZZ-7604104BKT	\$50 ^{.95} PR
71-73	Special Order Colors	D1ZZ-7604104SOT	\$50 ^{.95} PR

TMI TILTING HEADRESTS



5 Position Tilt Mechanism. Simple Bolt On Installation. Adds Style & Safety.



1964-67 TILTING HEADRESTS (TMI)

Year	Description	Part No.	List
64-67	Standard Seat -Black	HR-BK	\$296 ^{.95} PR
64-65	Standard Seat -Bright Red	HR-BR	\$296 ^{.95} PR
66-67	Standard Seat -Dark Red	HR-DR	\$296 ^{.95} PR
64-67	Light Blue	HR-LB	\$296 ^{.95} PR
64-67	Sport Seats -Black	SS-HR-BK	\$296 ^{.95} PR
64-65	Sport Seats -Bright Red	SS-HR-BR	\$296 ^{.95} PR
66-67	Sport Seats -Dark Red	SS-HR-DR	\$296 ^{.95} PR
64-67	Sport Seats -Light Blue	SS-HR-LB	\$296 ^{.95} PR

TMI PONY CONSOLES



Feature deep cupholders, map pockets, & hidden hinge.



1964-73 ONE COLOR NO TRIM (TMI)

Year	Description	Part No.	List
64-73	CP/FB Black w/o Factory Console	PC-CP-BK	\$119 ^{.95} EA
64-73	Conv.Black w/o Factory Console	PC-CV-BK	\$119 ^{.95} EA
64-67	Black w Factory Console	PC-BK	\$119 ^{.95} EA
64-73	Spec.Order Specify Color/Body Style	PC-SO	\$119 ^{.95} EA

1964-73 ONE COLOR CHROME TRIM (TMI)

Year	Description	Part No.	List
64-73	CP/FB Black w/Chrome Trim w/o Factory Console	PC-CP-BK/CHR	\$129 ^{.95} EA
64-73	Conv.Black w/ Chrome trim w/o Factory Console	PC-CV-BK/CHR	\$129 ^{.95} EA
64-67	Black w/Chrome Trim w/ Factory Console	PC-BK-C	\$129 ^{.95} EA
64-73	Spec.Order w/Chrome Trim w/o Factory Console, Specify Color/Body Style	PC-SO/CHR-1	\$129 ^{.95} EA
65-67	Spec.Order w/Chrome Trim w/Factory Console, Specify Color/Body Style	PC-SO-C-1	\$129 ^{.95} EA

1964-73 TWO COLORS CHROME TRIM (TMI)

Year	Description	Part No.	List
64-73	Chrome Trim w/o Factory Console, Specify Colors/Body Style, 2-Tone	PC-SO/CHR-2	\$159 ^{.95} EA
64-67	Chrome Trim w/ Factory Console Specify Colors/Body Style, 2-Tone	PC-SO/CHR-C2	\$159 ^{.95} EA

TMI STANDARD UPHOLSTERY



1964-73 ONE COLOR NO TRIM (TMI)

Year	Description	Part No.	List
64-65	Black,Coupe	65CP-S-FULL-BKT	\$224 ^{.95} SE
64-65	Spec. Order Colors-Coupe	65CP-S-FULL-SOT	\$224 ^{.95} SE
64-65	Black, Convertible	65CV-S-FULL-BKT	\$224 ^{.95} SE
64-65	Spec. Order Colors-Convrt.	65CV-S-FULL-SOT	\$224 ^{.95} SE
64-65	Black, Fastback	65FB-S-FULL-BKT	\$224 ^{.95} SE
64-65	Spec. Order Colors-Fastback	65FB-S-FULL-SOT	\$224 ^{.95} SE
66	Black, Coupe	66CP-S-FULL-BKT	\$224 ^{.95} SE
66	Spec. Order Colors-Coupe	66CP-S-FULL-SOT	\$224 ^{.95} SE
66	Black, Convertible	66CV-S-FULL-BKT	\$224 ^{.95} SE
66	Spec. Order Colors-Convrt.	66CV-S-FULL-SOT	\$224 ^{.95} SE
66	Black, Fastback	66FB-S-FULL-BKT	\$224 ^{.95} SE
66	Spec. Order Colors-Fastback	66FB-S-FULL-SOT	\$224 ^{.95} SE
67	Black,Coupe	67CP-S-FULL-BKT	\$224 ^{.95} SE
67	Spec. Order Colors-Coupe	67CP-S-FULL-SOT	\$224 ^{.95} SE
67	Black,Convertible	67CV-S-FULL-BKT	\$224 ^{.95} SE
67	Spec. Order Colors-Convrt.	67CV-S-FULL-SOT	\$224 ^{.95} SE
67	Black, Fastback	67FB-S-FULL-BKT	\$224 ^{.95} SE
67	Spec. Order Colors-Fastback	67FB-S-FULL-SOT	\$224 ^{.95} SE

1968-69 STANDARD UPHOLSTERY (TMI)

Year	Description	Part No.	List
68	Black,Coupe	68CP-S-FULL-BKT	\$234 ^{.95} SE
68	Spec. Order Colors-Coupe	68CP-S-FULL-SOT	\$234 ^{.95} SE
68	Black, Convertible	68CV-S-FULL-BKT	\$234 ^{.95} SE
68	Spec. Order Colors-Convrt.	68CV-S-FULL-SOT	\$234 ^{.95} SE
68	Black, Fastback	68FB-S-FULL-BKT	\$234 ^{.95} SE
69	Black,Coupe	69CP-S-FULL-BKT	\$234 ^{.95} SE
69	Special Order Colors-Coupe	69CP-S-FULL-SOT	\$234 ^{.95} SE
69	Black,Convertible	69CV-S-FULL-BKT	\$234 ^{.95} SE
69	Spec. Order Colors-Conv.	69CVS-FULL-SOT	\$234 ^{.95} SE
69	Black, Fastback	69FB-S-FULL-BKT	\$234 ^{.95} SE
69	Spec. Order Colors. Fastback	69FB-S-FULL-SOT	\$234 ^{.95} SE

1970-73 STANDARD UPHOLSTERY (TMI)

Year	Description	Part No.	List
70	Black,Coupe	70CP-S-FULL-BKT	\$290 ^{.95} SE
70	Special Order Colors-Coupe	70CP-S-FULL-SOT	\$290 ^{.95} SE
70	Black, Convertible	70CV-S-FULL-BKT	\$290 ^{.95} SE
70	Special Order Colors-Conv.	70CV-S-FULL-SOT	\$290 ^{.95} SE
70	Black, Fastback	70FB-S-FULL-BKT	\$290 ^{.95} SE
70	Spec. Order Colors-Fastback	70FB-S-FULL-SOT	\$290 ^{.95} SE
71	Black, Coupe	71CP-S-FULL-BKT	\$290 ^{.95} SE
72-73	Black,Coupe	72CP-S-FULL-BKT	\$290 ^{.95} SE
71-73	Black,Convertible	71CV-S-FULL-BKT	\$290 ^{.95} SE
71-73	Black, Fastback	71-CV-S-FULL-SOT	\$290 ^{.95} SE
71-73	Black Fastback	71-FB-S-FULL-BKT	\$290 ^{.95} SE
71-73	Spec. Order Colors -Fastback	71-FB-S-FULL-SOT	\$290 ^{.95} SE

TMI DELUXE UPHOLSTERY



1964-66 DELUXE UPHOLSTERY (TMI)

Year	Description	Part No.	List
64-66	Black, Coupe	65CP-P-FULL-BKT	\$299 ^{.95} SE
64-66	Spec. Order Colors-Coupe	65CP-P-FULL-SOT	\$299 ^{.95} SE
64-66	Black, Convertible	65CV-P-FULL-BKT	\$294 ^{.95} SE
64-66	Spec. Order Colors-Conv.	65CV-P-FULL-SOT	\$294 ^{.95} SE
64-66	Black, Fastback	65FB-P-FULL-BKT	\$294 ^{.95} SE
64-66	Spec. Order Colors-Fastback	65FB-P-FULL-SOT	\$294 ^{.95} SE

Interior

WE PROUDLY FEATURE AUTHENTIC MUSTANG REPRODUCTIONS FROM SCOTT DRAKE!



169

TMI DELUXE UPHOLSTERY

Comfortweave, Houndstooth, and Tweed..



1969-70 DELUXE UPHOLSTERY (TMI)			
Year	Description	Part No.	List
69	Black w/Black, Coupe	69CP-D-FULL-BKT	\$419 ⁹⁵ SE
69	Spec.Order Colors-Coupe	69CP-D-FULL-SOT	\$419 ⁹⁵ SE
69	Black w/Black, Convertible	69CV-D-FULL-BKT	\$419 ⁹⁵ SE
69	Spec.Order Colors-Conv.	69CV-D-FULL-SOT	\$419 ⁹⁵ SE
69	Black w/Black, Fastback	69FB-D-FULL-BKT	\$419 ⁹⁵ SE
69	Spec.Order Colors-Fastback	69FB-D-FULL-SOT	\$419 ⁹⁵ SE
70	Black w/Black Coupe	70CP-D-FULL-BKT	\$419 ⁹⁵ SE
70	Spec.Order Colors-Coupe	70CP-D-FULL-SOT	\$419 ⁹⁵ SE
70	Black w/Black Convertible	70CV-D-FULL-BKT	\$419 ⁹⁵ SE
70	Spec.Order Colors-Conv.	70CV-D-FULL-SOT	\$419 ⁹⁵ SE
70	Black w/Black Fastback	70FB-D-FULL-BKT	\$419 ⁹⁵ SE
70	Spec.Order Colors-Fastback	70FB-D-FULL-SOT	\$419 ⁹⁵ SE

1971-73 DELUXE UPHOLSTERY (TMI)			
Year	Description	Part No.	List
71	Special Order Colors, Coupe	71CP-D-FULL-SOT	\$424 ⁹⁵ SE
71	Special Order Colors, Cnvert.	71CV-D-FULL-SOT	\$424 ⁹⁵ SE
72-73	Special Order Colors, Coupe	72-CP-D-FULL-SOT	\$424 ⁹⁵ SE
72-73	Spe. Order Colors, Sportroof	72FB-D-FULL-SOT	\$424 ⁹⁵ SE

TMI MACH 1 UPHOLSTERY



1964-66 MACH 1 UPHOLSTERY (TMI)			
Year	Description	Part No.	List
69	Black w/Red Stripe, Sprtroof	69-M-FULL-B/R-T	\$424 ⁹⁵ SE
69	Special Order Colors, Sprtroof	69-M-FULL-S/O-T	\$424 ⁹⁵ SE
70	Black w/Red Stripe, Sprtroof	70-M-FULL-B/R-T	\$424 ⁹⁵ SE
70	Spe. Order Colors, Sprtroof	70-M-FULL-S/O-T	\$424 ⁹⁵ SE
71-73	Special Order Colors, Sprtroof	71-M-FULL-S/O-T	\$424 ⁹⁵ SE

TMI PONY SPORT SEAT UPHOLSTERY



1964-67 PONY SPORT SEAT (TMI)			
Year	Description	Part No.	List
64-67	Pony, CP Black	SS-65CP-FULL-BK	\$369 ⁹⁵ SE
64-67	Pony, CP Blue	SS-65CP-FULL-BL	\$369 ⁹⁵ SE
64-67	Pony, CP Bright Red	SS-65CP-FULL-BR	\$369 ⁹⁵ SE
64-67	Pony, CP Dark Red	SS-66-CP-FULL-DR	\$369 ⁹⁵ SE
64-67	Pony, CV Black	SS-65CV-FULL-BK	\$369 ⁹⁵ SE
64-67	Pony, CV Black	SS-65CV-FULL-BL	\$369 ⁹⁵ SE
64-67	Pony, CV Bright Red	SS-65CV-FULL-BR	\$369 ⁹⁵ SE
64-67	Pony, CV Dark Red	SS-66CV-FULL-DR	\$369 ⁹⁵ SE
64-67	Pony, FB Black	SS-65FB-FULL-BK	\$369 ⁹⁵ SE
64-67	Pony, FB Blue	SS-65FB-FULL-BL	\$369 ⁹⁵ SE
64-67	Pony, FB, Bright Red	SS-65FB-FULL-BR	\$369 ⁹⁵ SE
64-67	Pony, FB, Bright Red	SS-65FB-FULL-BR	\$369 ⁹⁵ SE
64-67	Pony, FB, Dark Red	SS-66FB-FULL-DR	\$369 ⁹⁵ SE

TMI SPORT SEAT UPHOLSTERY



1967 SPORT SEAT (TMI)			
Year	Description	Part No.	List
67	Standard, CP Black	SS-67-CP-FULL-BK	\$369 ⁹⁵ SE
67	Standard, CP Blue	SS-67CP-FULL-BL	\$369 ⁹⁵ SE
67	Standard, CP Dark Red	SS-67CP-FULL-DR	\$369 ⁹⁵ SE
67	Standard, CV Black	SS-67CV-FULL-BK	\$369 ⁹⁵ SE
67	Standard, CV, Blue	SS-67CV-FULL-BL	\$369 ⁹⁵ SE
67	Standard, CV, Dark Red	SS-67CV-FULL-DR	\$369 ⁹⁵ SE
67	Standard, FB, Black	SS-67FB-FULL-BK	\$369 ⁹⁵ SE
67	Standard, FB, Blue	SS-67FB-FULL-BL	\$369 ⁹⁵ SE
67	Standard, FB, Dark Red	SS-67FB-FULL-DR	\$369 ⁹⁵ SE

TMI MACH 1 & DELUXE SPORT SEAT UPHOLSTERY



1964-66 MACH 1 & DLX SPORT SEAT UP			
Year	Description	Part No.	List
69-70	Mach 1 Special Order Colors	SS-69-M-FULL-SO	\$459 ⁹⁵ SE
71-73	Mach 1 Special Order Colors	SS-71-M-FULLSOT	\$459 ⁹⁵ SE
71-73	Deluxe Special Order Colors	SS-71-D-FULLSOT	\$459 ⁹⁵ SE

TMI SPORT II SEAT UPHOLSTERY



Custom Colors available. Utilizes the factory seat frames. Transforms flat factory seats into G-force absorbing sport seats



1965-68 SPORT II (TMI)			
Year	Description	Part No.	List
65	Specify Color /Body Style	SS2-65-FULL-SO	\$389 ⁹⁵ SE
66	Specify Color /Body Style	SS2-66-FULL-SO	\$389 ⁹⁵ SE
67	Specify Color /Body Style	SS2-67-FULL-SO	\$389 ⁹⁵ SE
68	Specify Color /Body Style	SS2-68-FULL-SO	\$389 ⁹⁵ SE

TMI MACH I & DELUXE SPORT II UPHOLSTERY



Keep your factory seat! Utilizes the factory seat frame.



1969-73 MACH I & DELUXE SPORT II (TMI)			
Year	Description	Part No.	List
69-70	Specify Color /Body Style	SS2-69-FULL-SO	\$534 ⁹⁵ SE
71-73	Specify Color /Body Style	SS2-71-FULL-SO	\$534 ⁹⁵ SE

TMI SPORT R SEAT UPHOLSTERY



Custom styling using OE patterns! Modern restomod styling with suede inserts and contrast stitching. Specify color / body styling



1969-73 MACH I & DELUXE SPORT II (TMI)			
Year	Description	Part No.	List
65	Standard/Deluxe	SSR-65-FULL-SO	\$439 ⁹⁵ SE
66	Standard/Deluxe	SSR-66-FULL-SO	\$439 ⁹⁵ SE
67	Standard/Deluxe	SSR-67-FULL-SO	\$439 ⁹⁵ SE
68	Standard/Deluxe	SSR-68-FULL-SO	\$439 ⁹⁵ SE
69-70	Mach 1	SSR-69-FULL-SO	\$534 ⁹⁵ SE
71-73	Match 1	SSR-71-FULL-SO	\$534 ⁹⁵ SE

SPORT SEAT FOAM



TMI Exclusive easy-install molded seat foam with molded-in listing wires saves time & aggravation. *Requires 2 per car



STOCK STD PONY & MACH 1(TMI)

Year	Description	Part No.	List
64-67	Pony/STD Sport SeatFoam	C5ZZ6560050/1SS	\$114. ⁹⁵ SE
68-69	Std./Dlx.Sport Seat Foam	C8ZZ6560050/1SS	\$114. ⁹⁵ SE
69-70	Mach1 Sport SeatFoam	C9ZZ6560050/1SS	\$149. ⁹⁵ SE
71-73	Mach1 /Dlx. Sport Seat	D1ZZ6560050/1SS	\$149. ⁹⁵ SE

STOCK SEAT FOAM



TMI Exclusive easy-install molded seat foam with molded-in listing wires saves time & aggravation. *Requires 2 per car



STOCK (TMI)

Year	Description	Part No.	List
64-66	Standard Seat Foam	C5ZZ-65600501ST	\$74. ⁹⁵ SE
64-66	Deluxe Pony Seat Foam	C5ZZ-65600501PT	\$74. ⁹⁵ SE
67	STD/DLX Seat Foam	C7ZZ-65600501ST	\$74. ⁹⁵ SE
68-69	STD/DLX Seat Foam	C8ZZ-65600501ST	\$74. ⁹⁵ SE

STOCK (TMI)

Year	Description	Part No.	List
70	STD/DLX Seat Foam	D0ZZ-65600501ST	\$124. ⁹⁵ SE
69-70	Mach 1 Seat Foam	C911-65600501MT	\$124. ⁹⁵ SE
71-73	STD/DLX Seat Foam	D1ZZ-65600501ST	\$124. ⁹⁵ SE

TMI SPORT R II SEAT FOAM



1964-73 SPORT R II SEAT FOAM(TMI)

Year	Description	Part No.	List
64-67	Low Back	C5ZZ-6560050/RSS	\$124. ⁹⁵ SE
68-69	Low Back	C8ZZ6560050/RSS	\$124. ⁹⁵ SE
69-70	High Back	C9ZZ6560050/RSS	\$124. ⁹⁵ SE
71-73	High Back	D1ZZ6560050/RSS	\$124. ⁹⁵ SE
71-73	High Back	D1ZZ6560050/RSS	\$124. ⁹⁵ SE

1964-73 (TMI)

Year	Description	Part No.	List
64-70	Fastback Rear Seat Foam	C5ZZ-65600501RT	\$152. ⁹⁵ SE

KEYS & LOCKS

LOCKS 7 LATCHES

DOOR HANDLE SHAFT ASSEMBLY



Gold cadmium plated and made from our own tooling. Our 64-66 standard interior shafts will accomodate early clip-on handles.

Year	Description	Part No.	List
64-66	Standard, RH	C5ZZ-6521818-C	\$14. ⁹⁵ EA
64-66	Standard, LH	C5ZZ-6521819-C	\$14. ⁹⁵ EA
65-66	Pony, RH	C5ZZ-6521818-B	\$14. ⁹⁵ EA
65-66	Pony, LH	C5ZZ-6521819-B	\$14. ⁹⁵ EA
67-68	RH	C60Z-6221818-B	\$14. ⁹⁵ EA
67-68	LH	C60Z-6221819-B	\$14. ⁹⁵ EA

DOOR LATCH



This door latch assembly is a beautiful copy of a complicated stamping. Comes fully assembled and ready to install.

Year	Description	Part No.	List
65-66	RH	C4SZ-6321812-C	\$59. ⁹⁵ EA
65-66	LH	C4SZ-6321813-C	\$59. ⁹⁵ EA
67-68	RH	C60Z-6221812-A	\$65. ⁹⁵ EA
67-68	LH	C60Z-6221813-A	\$65. ⁹⁵ EA
69-70	RH	C9AZ-6221812-A	\$74. ⁹⁵ EA
69-70	LH	C9AZ-6221813-A	\$74. ⁹⁵ EA

DOOR LATCH LOCK RODS



Set of three door lock rods. Zinc plated for years of service.

Year	Description	Part No.	List
65-66	LH, set of 3	C5ZZ-65213452LH	\$24. ⁹⁵ SE
65-66	RH, set of 3	C5ZZ-65213452RH	\$24. ⁹⁵ SE
67-68	LH, set of 3	C7ZZ-65213452LH	\$24. ⁹⁵ SE
67-68	RH, set of 3	C7ZZ-65213452RH	\$24. ⁹⁵ SE

DOOR LOCK/LATCH ROD SET

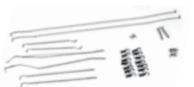

Complete set of door latch and lock rods for both doors. Includes retaining clips.

Year	Part No.	List
67-68	C7ZZ-6521940-KT	\$79. ⁹⁵ SE
69-70	C9ZZ-6521940-KT	\$79. ⁹⁵ SE

DOOR LATCH RETAINER BUSHING



Door Latch Retainer Bushing. 4 piece kit.

Year	Part No.	List
64-66	C4SZ-6321801-C	\$4. ⁹⁵ KI

DOOR LATCH ROD RETAINER

This is the original, concours type door rod retainer that connect the four rods to the latch and lock assemblies inside the doors. There are six of these used in each door. Concours version offers a longer lasting and more secure fit than economy versions.



65-66
White economy replacement
C3AZ-6221952-A

List

\$2.²⁵ EA



64-66
Concours
C3AZ-6221952-BR

List

\$4.⁹⁵ EA



67-73
Concours
C5AZ-6221952-AR

List

\$4.⁹⁵ EA

DOOR LATCH SPRING



Correct stainless steel spring for door latch. This part is often broken and preventing latch from working properly.

Year	Part No.	List
67-70	357212-S	\$7. ⁵⁰ EA

WE PROUDLY FEATURE AUTHENTIC MUSTANG REPRODUCTIONS FROM SCOTT DRAKE!



DOOR LOCK KNOB

Made by Plastic injection. Sold as a pair. Available in chrome, or satin chrome.



64 1/2: Black
C3AZ-6221850-BK

List

\$7.50^{EA}



65-66: Chrome
C5DZ-6221850-A

List

\$5.00^{PR}



65-66: Satin chrome
C5DZ-6221850-S

List

\$5.00^{PR}



67: Chrome
C5AZ-6221850-A

List

\$6.00^{PR}



68-73: Chrome, concours
C8AZ-6221850-A

List

\$5.00^{PR}

DOOR LOCK KNOB GROMMET

The grommet that goes around the door lock knob, comes in clear, chrome or stainless.



64 1/2: All
Black plastic
C2OZ-6221999-BK

List

\$4.95^{EA}



65-68: All 69-73
Standard interior Clear plastic
C5DZ-6221999-B

List

\$0.75^{EA}



65-68: All 69-73
Standard interior Chrome
C5DZ-6221999-C

List

\$3.50^{PR}



69-73
Deluxe interior Stainless steel
D0DZ-6221999-AR

List

\$6.95^{PR}

STRIKER ASSEMBLY



64-66
Gold zinc, Date coded 1-65
C2OZ-6222008-B

List

\$12.95^{SE}



Original factory type
striker. Includes
attaching parts.

Year	Description	Part No.	List
68-70	Silver zinc, date coded 8-66	C5AZ-6222008-A	\$14.95 ^{SE}
68-70	Silver zinc, date coded 11-67	C5AZ-6222008-B	\$14.95 ^{SE}

POLISHED STAINLESS STEEL STRIKER ASSEMBLY

New by Drake, these Mustang Door Strikers feature highly polished stainless steel for that perfect finish. Includes stainless steel hardware.

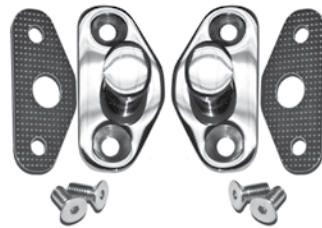

Year	Description	Part No.	List
64-66	Set of 2	C2OZ-6222008-SS	\$59.95 ^{SE}
67-70	Set of 2	C5AZ-6222008-SS	\$59.95 ^{SE}



71-80
Silver zinc
D2AZ-6522008-A

List

\$10.95^{EA}

STRIKER PLATE SCREW



Gold cadmium plated screws
to attach door strikers.

Year	Description	Part No.	List
64-70	Set of 4	378428-S	\$3.50 ^{SE}

DOOR LATCH PLATE REPAIR KIT



Easily repairs cracked
door latch mounting holes.
Includes mounting screws.

Year	Part No.	List
64-66	C5ZZ-6528160/1A	\$22.95 ^{KI}
67-68	C7ZZ-6528160/1A	\$22.95 ^{KI}

DOOR LATCH REINFORCEMENT KIT



Door Latch Reinforcement
Kit Does Both Doors, 12
piece kit includes 6 bolts
and 6 washers.

Year	Part No.	List
64-70	C0DB-3447	\$7.95 ^{KI}

DOOR & IGNITION LOCK KIT



Convenient matched kits
save costly locksmith
work. Kits include a pair
of door lock cylinders
and an ignition cylinder.

Comes with two keys. 1967 - 1969 include door cylinder gaskets. See "Keys, Locks, & Latches" for complete listing of Door Locks.

Year	Description	Part No.	List
64-66	Standard keys	C5DZ-6222050-A	\$32.95 ^{SE}
65-66	Pony keys OLP	C5DZ-6222050-B	\$36.95 ^{EA}
67-69	Standard keys	C9AZ-6222050-A	\$27.95 ^{SE}
67-69	Pony keys OLP	C9AZ-6222050-B	\$30.95 ^{SE}
70-73	Standard keys	D2AZ-6222050-A	\$29.95 ^{SE}

MULTIPLE DOOR & IGNITION LOCK KITS



Multiple Mustang
owners, simplify your
life with these matched
sets for either 2 or 3
cars. 1 single key will
start up to 3 cars and

open 6 doors. No more grabbing the wrong keys or fumbling through multiple keys trying to open a door or start a car. You also don't need to worry about a spare. These kits come with either 4 or 6 matched keys. So there is plenty for all the family to have one and a hidden key as well.

Year	Description	Part No.	List
64-66	2 cars	C5DZ-6222050-2	\$64.95 ST
67-69	2 cars	C9AZ-6222050-2	\$49.95 ST
67-69	3 cars	C9AZ-6222050-3	\$74.95 ST

DOOR, IGNITION AND TRUNK LOCK

KIT



Our quality lock set with all locks keyed the same. No separate trunk lock key.

Year	Part No.	List
67-69	C7AZ-6222050-MK	\$45.95 SE

DOOR LOCK KIT



These door lock cylinders assure your customers of a durable part and a perfect fit. Available in pairs only.

Part No.	Year	List
D2AZ-6521984-A	67-73	\$15.95 PR

IGNITION CYLINDER AND KEYS



Our ignition lock sets are all new. Two keys included.

Year	Part No.	List
64-66	C50Z-11582-A	\$8.95 EA
67-69	C9AZ-11582-A	\$8.50 EA
71-73	D2AZ-11582-B	\$10.95 EA

IGNITION SWITCH BEZEL

A perfect reproduction with concours chrome.



C3AZ-11584-A
64-66

List
\$9.95 EA

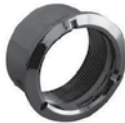

C60Z-11584-A
67-68

List
\$11.95 EA



C9AZ-11584-A
69

List
\$19.95 EA

IGNITION SWITCH RETAINER

A "must have" part when installing an ignition switch. Zinc plated for years of service.



C4DZ-10A885-A
64-66

List
\$6.00 EA



C7ZZ-11A590-B
67-68

List
\$8.95 EA

GLOVEBOX LATCH



All new tooling was created to produce our glovebox latches. These are very nice. Also available as a locking version with keys.

Year	Description	Part No.	List
64-65	Standard, curved glove box door	CSZZ-6506072-A	\$18.95 EA
65-66	Deluxe, flat glove box door	CSZZ-6506072-B	\$18.95 EA
67-68		C6DZ-6506072-A	\$18.95 EA
69-70		C9ZZ-6506072-A	\$18.95 EA

LOCKABLE GLOVEBOX LATCH



A great optional accessory from Scott Drake. All new tooling was created to produce our glovebox latches. Includes 2 matching keys.

Year	Description	Part No.	List
64-65	Standard, curved door	CSZZ-6506072-AL	\$21.95 SE
65-66	Deluxe, flat door	CSZZ-6506072-BL	\$21.95 SE
67-68		C6DZ-6506072-AL	\$21.95 EA
69-70		C9ZZ-6506072-AL	\$21.95 SE

GLOVEBOX STRIKER KIT



Exact reproduction of the original. Hardware included. Also available in bright Chrome Finish.

Year	Description	Part No.	List
64-66	Zinc	CSZZ-6506064-A	\$7.95 SE
64-66	Chrome	CSZZ-6506064-C	\$8.95 SE

GLOVEBOX AND TRUNK LOCK KIT



New from Scott Drake. All new tooling was created to produce our glovebox latches. This kit allows the

use of one key for the glovebox and trunk lock.

Year	Part No.	List
67-68	C6DZ-6506072-K	\$34.95 SE
69-70	C9ZZ-6506072-K	\$34.95 SE

TRUNK LOCK CYLINDER



Our trunk cylinders are an exact copy, but the keys are a replacement type. Also available with Pony keys.

67-73 includes gasket and retainer.

Year	Description	Part No.	List
64-66	Standard keys	C50Z-6243505-B	\$37.95 EA
64-66	Pony keys OLP	C50Z-6243505-P	\$39.95 EA
67-73	Standard keys	C7AZ-6243505-B	\$14.95 EA
67-73	Pony keys OLP	C7AZ-6243505-P	\$19.95 EA

TRUNK LOCK STEM EXTENSION



Exact reproductions of the originals for a perfect fit and the right look. Not included with trunk lock cylinders.

Year	Description	Part No.	List
64-66	Concours	CSZZ-6543283-A	\$4.95 EA
67-68	Concours	C7ZZ-6543283-AR	\$3.25 EA
69-73	Economy, must cut to fit	C7ZZ-6543283-A	\$2.95 EA

TRUNK LOCK CYLINDER SLEEVE



Pressure die cast with show car chrome. Comes with nut, washer and gasket.

Year	Part No.	List
64-66	CSZZ-6543603-B	\$9.95 KI

TRUNK LOCK HOUSING SPACER



Stamped steel housing spacer that attaches behind chrome trunk housing. Zinc plated

Year	Part No.	List
64-66	CSZZ-6543565-A	\$11.95 EA

WE PROUDLY FEATURE AUTHENTIC MUSTANG REPRODUCTIONS FROM SCOTT DRAKE!



DOOR & TRUNK LOCK CYLINDER

RETAINER



Year	Part No.	List
67-80	CSAZ-6222023-A	\$2.50 ^{EA}

TRUNK LATCH STRIKER



Exact detail made from heavy gauge steel. 65-66 available in silver zinc or bright chrome. 67-70 painted black.

Year	Description	Part No.	List
64-66	Zinc	C40B-6243252	\$10.95 ^{EA}
64-66	Chrome	C40B-6243252-C	\$12.95 ^{EA}
67-68	Black	C7Z-6243252	\$14.95 ^{EA}
69-70	Black	C9Z-6243252	\$14.95 ^{EA}

TRUNK LATCH STRIKER



Heavy duty steel stamped construction with a bright zinc plated finish

Year	Part No.	List
64-66	C20Z-6243200-B	\$34.95 ^{EA}
67-73	CSAZ-6243200-A	\$42.95 ^{EA}

WIRELESS TRUNK RELEASE



Designed for use with our Electric Trunk Release Kits (above). Easy to install and adds modern convenience.

Includes two wireless remotes.

Year	Part No.	List
65-70	CSZ-6243200-WR	\$49.95 ^{KI}

TRUNK RELEASE



High quality chrome with improved cable. Includes chrome base, lever cable, and all mounting hardware. (Note:

67-70 release only works on cars that come factory equipped with this option. All others refer to electronic version)

Year	Description	Part No.	List
64-66	All	C4AZ-62432A00-A	\$54.95 ^{KI}
67-70	Factory equipped only	C7AZ-62432A00-A	\$54.95 ^{KI}

ELECTRIC TRUNK RELEASE KIT



We combined the classic look of the original remote trunk release with a chrome release lever and a strong

electric solenoid driven latch with a modern micro switch release. Now, with a light finger pull the trunk lid opens. No cables to stretch or corrode. Simple 30 minute installation with no modifications to the car. All mounting hardware and connectors are included. Year Coupe, Fastback and Convertible.

Year	Part No.	List
64-66	CSAZ-6243200-EL	\$99.95 ^{KI}
67-70	C7AZ-6243200-EL	\$99.95 ^{KI}

KEYS

KEY

Little touches make a big difference. These blanks have the correct Ford script or running horse.



64-66: Pony, ignition
And door
CSZ-6522053-B

List
\$2.00 ^{EA}



64-66: Pony, trunk
And glovebox
CSZ-6543562-B

List
\$2.00 ^{EA}



67-73: Pony, ignition
and door
C7AZ-6222053-H

List
\$2.95 ^{EA}



67-73: Pony, trunk and
Glovebox
C7AZ-6243562-H

List
\$2.95 ^{EA}

HOOD LOCKS & PINS

HOOD PIN KIT

Classic hood pins and all hardware needed to install them.



64-73: w/ cables, all Stainless
C5Z-16892-SSK

List
\$44.95 ^{SE}



64-73: Faux, stick-on
C8Z-16C896-F

List
\$59.95 ^{PR}



69: Mach 1
C90Z-16700-A

List
\$84.95 ^{KI}



64-73: w/out cables
S1MS-16892-A

List
\$16.95 ^{KI}



64-73: w/ cables
S1MS-16892-DLX

List
\$23.95 ^{KI}



64-73: Billet, w/ cables
S1MS-16892-K

List
\$74.95 ^{SE}



67: w/ cables, Shelby, concours
S7MS-16892-A

List
\$118.50 ^{PR}

HOOD TWIST LOCK

Beautiful chrome handle that is turned to lock the hood down.



68: Shelby and California Special
C8Z-16C896-A

List
\$114.95 ^{PR}



70: Chrome
D0ZZ-16C896-A

List
\$89.95 ^{EA}



71-73: Ram Air
D1ZZ-16896

List
\$89.95 ^{EA}



69-70: Shelby
S9MS-16C892-A

List
\$74.95 ^{PR}

HOOD LOCK BRACKET

California Special Hood Lock Bracket. Stamped steel construction. Sold individually.

Year	Description	Part No.	List
68	California Special	C8ZZ-16934-A	\$39. ⁹⁵ EA

HOOD TWIST LOCK CATCH

This is the catch for the twist lock. Mounts to radiator support.

Year	Part No.	List
70-73	D0ZZ-16894	\$9. ⁹⁵ EA

HOOD TWIST LOCK RETAINER

Retainer that mounts to the bottom side of hood to accept the hood lock.

Year	Part No.	List
70-73	D0ZZ-16712	\$11. ⁹⁵ EA

LITERATURE**ASSEMBLY & OWNERS MANUALS****BODY ASSEMBLY MANUAL**

This manual shows how to attach all body components and gives you the actual Ford part numbers for the hardware needed.

Year	Part No.	List
64	AM-1	\$15. ⁹⁵ EA
65	AM-6	\$15. ⁹⁵ EA
66	AM-11	\$15. ⁹⁵ EA
67	AM-16	\$15. ⁹⁵ EA
68	AM-21	\$15. ⁹⁵ EA
69	AM-26	\$15. ⁹⁵ EA
70	AM-31	\$15. ⁹⁵ EA
71-72	AM-41	\$15. ⁹⁵ EA
73	AM-46	\$15. ⁹⁵ EA

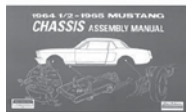
CHASSIS ASSEMBLY MANUAL

This book shows every aspect of the steering, suspension, exhaust and all other chassis components as well as all mounting hardware.

Year	Part No.	List
64-65	AM-5	\$15. ⁹⁵ EA
67	AM-20	\$15. ⁹⁵ EA
68	AM-25	\$15. ⁹⁵ EA
69	AM-30	\$15. ⁹⁵ EA
70	AM-35	\$15. ⁹⁵ EA
73	AM-50	\$15. ⁹⁵ EA

CONVERTIBLE TOP REPAIR MANUAL

The convertible top is the most complicated part of any car. This manual features complete top adjustments, servicing, electrical and trouble-shooting. 15 pages soft bond

Year	Part No.	List
64-66	MP-14	\$8. ⁵⁰ EA

ELECTRICAL ASSEMBLY MANUAL

This Electrical Assembly Manual features detailed drawings and schematics of the electrical system. Very easy to read.

Year	Part No.	List
64	AM-3	\$15. ⁹⁵ EA
65	AM-8	\$15. ⁹⁵ EA
66	AM-13	\$15. ⁹⁵ EA
67	AM-18	\$15. ⁹⁵ EA
68	AM-23	\$15. ⁹⁵ EA
69	AM-28	\$15. ⁹⁵ EA
70	AM-33	\$15. ⁹⁵ EA
71-72	AM-43	\$15. ⁹⁵ EA

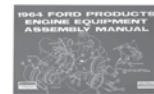
ENGINE COMPONENT ASSEMBLY MANUAL

Year	Part No.	List
64	AM-154	\$15. ⁹⁵ EA
65	AM-155	\$15. ⁹⁵ EA
66	AM-156	\$15. ⁹⁵ EA
67	AM-157	\$15. ⁹⁵ EA
69	AM-159	\$15. ⁹⁵ EA

EXPLODED VIEW ILLUSTRATION MANUAL

Shows all Ford illustrations, easy to read, great for seeing how assemblies fit together. Also lists basic part numbers.

Year	Part No.	List
64-65	MP-309	\$9. ⁹⁵ EA
66	MP-347	\$9. ⁹⁵ EA
67-68	MP-313	\$9. ⁹⁵ EA
69-70	MP-348	\$9. ⁹⁵ EA

INTERIOR ASSEMBLY MANUAL

This manual is perfect for showing the proper placement of each interior component. From headliner to carpet and even the Ford part numbers for the attaching hardware, this book has it all.

Year	Part No.	List
64	AM-2	\$15. ⁹⁵ EA
65	AM-7	\$16. ⁹⁵ EA
66	AM-12	\$15. ⁹⁵ EA
67	AM-17	\$15. ⁹⁵ EA
68	AM-22	\$15. ⁹⁵ EA
70	AM-32	\$15. ⁹⁵ EA
71-72	AM-37	\$15. ⁹⁵ EA

WE PROUDLY FEATURE AUTHENTIC MUSTANG REPRODUCTIONS FROM SCOTT DRAKE!



SHOP MANUAL

A must for anyone planning to work on their own car. This is an easy sell when your customers start looking through the

wealth of information contained in these books. All books contain detailed instructions on disassembly and assembly of all major components as well as frame squaring specs.

Year	Description	Part No.	List
64	Supplement	MP-27	\$8. ⁹⁵ EA
64		SM-64	\$50. ⁹⁵ EA
65		SM-65	\$48. ⁹⁵ EA
66		SM-66	\$50. ⁹⁵ EA
67		SM-67	\$50. ⁹⁵ EA
68		SM-68	\$50. ⁹⁵ EA
69		SM-69	\$79. ⁹⁵ SE
70		SM-70	\$79. ⁹⁵ SE
71		SM-71	\$79. ⁹⁵ SE
72		SM-72	\$79. ⁹⁵ SE
73		SM-73	\$79. ⁹⁵ SE
73	Emissions	SM-73-E	\$12. ⁹⁵ EA

OWNER'S MANUAL WALLETS

Protect your owner's manual, registration and insurance card with an owner's manual wallet from Scott Drake. This official licensed Ford product features

black vinyl construction with official logos and lettering on the front. The 3 clear vinyl pockets on the inside make ideal room for all your vehicles' important documents.



Part No.	Description	List
ACC-OMW-MUSTANG	Mustang	\$6. ⁰⁰ EA
ACC-OMW-COUGAR	Cougar	\$6. ⁰⁰ EA
ACC-OMW-FALCON	Falcon	\$6. ⁰⁰ EA
ACC-OMW-BRONCO	Bronco	\$6. ⁰⁰ EA

OWNERS MANUAL

Exact reprint of the original manual right down to the paper texture.



Year	Description	Part No.	List
64		OM-64	\$8. ⁹⁵ EA
65		OM-65	\$8. ⁹⁵ EA
65	Shelby	OM-65-S	\$9. ⁹⁵ EA
66		OM-66	\$8. ⁹⁵ EA
66	W/ HiPo Engine	OM-66-HP	\$9. ⁹⁵ EA
66	Shelby	OM-66-S	\$10. ⁹⁵ EA
67		OM-67	\$8. ⁹⁵ EA
67	Shelby	OM-67-S	\$9. ⁹⁵ EA
68		OM-68	\$8. ⁹⁵ EA
68	Shelby	OM-68-S	\$9. ⁹⁵ EA
69		OM-69	\$8. ⁹⁵ EA
69	Boss 429	OM-69-B	\$9. ⁹⁵ EA
70		OM-70	\$8. ⁹⁵ EA
70	Boss 429	OM-70-B	\$9. ⁹⁵ EA
70	Shelby	OM-70-S	\$9. ⁹⁵ EA
71	Ford car	OM-71	\$8. ⁹⁵ EA
71	Mustang supplement	OM-71-SS	\$4. ⁹⁵ EA
71	Boss 351	OM-71-B	\$9. ⁹⁵ EA
72		OM-72	\$8. ⁹⁵ EA
73		OM-73	\$8. ⁹⁵ EA

TILT-A-WAY COLUMN REPAIR & DIAGNOSTIC MANUAL

Year	Description	Part No.	List
67-69	Tilt-A-Way	MP-310	\$6. ⁹⁵ EA

VACUUM SCHEMATIC MANUAL

Saves time and frustration! Shows schematic and diagrams that reveal the location and function of the many vacuum systems on Mustangs and

Shelbys.

Part No.	Year	Description	List
MP-150	67	Mustang and Shelby	\$6. ⁰⁰ EA
MP-151	68	Mustang and Shelby	\$6. ⁰⁰ EA
MP-152	69	Mustang and Cougar	\$6. ⁰⁰ EA
MP-153	70	Mustang and Cougar	\$6. ⁰⁰ EA
MP-154	71	Mustang and Cougar	\$6. ⁰⁰ EA
MP-155	72	Mustang and Cougar	\$6. ⁰⁰ EA
MP-156	73	Mustang and Cougar	\$6. ⁰⁰ EA

WELD-SEALANT MANUAL

Anyone doing a total restoration and wanting to do it correctly needs this manual. While showing

proper drawings of every sheet metal part, it also illustrates where Ford put sealant and anti-rattle material as well as the proper Ford part numbers for them.

Part No.	Year	List
AM-19	67	\$22. ⁹⁵ EA
AM-24	68	\$22. ⁹⁵ EA
AM-34	70	\$23. ⁹⁵ EA
AM-39	71-72	\$22. ⁹⁵ EA
AM-9	64	\$22. ⁹⁵ EA

WIRING DIAGRAM MANUAL

Covers a multitude of electrical pictorial diagrams, color codes are listed, plus easy to follow schematics.

Note: Small print may be difficult for some to read. Also available in large, easy-to-read format (below).



Year	Part No.	List
64	MP-312	\$6. ⁹⁵ EA
65	MP-1	\$6. ⁹⁵ EA
66	MP-2	\$6. ⁹⁵ EA
67	MP-3	\$6. ⁹⁵ EA
68	MP-4	\$6. ⁹⁵ EA
69	MP-5	\$6. ⁹⁵ EA
70	MP-6	\$6. ⁹⁵ EA
71	MP-7	\$6. ⁹⁵ EA
72	MP-8	\$6. ⁹⁵ EA
73	MP-9	\$6. ⁹⁵ EA

LARGE FORMAT WIRING DIAGRAM MANUAL

Covers a multitude of electrical pictorial diagrams, color codes are listed, plus easy to follow schematics. Our large format features larger diagrams that are easier to read.



Year	Part No.	List
64	MP-311-P	\$12. ⁹⁵ EA
65	MP-1-P	\$12. ⁹⁵ EA
66	MP-2-P	\$12. ⁹⁵ EA
67	MP-3-P	\$12. ⁹⁵ EA
68	MP-4-P	\$12. ⁹⁵ EA
69	MP-5-P	\$12. ⁹⁵ EA
70	MP-6-P	\$12. ⁹⁵ EA
71	MP-7-P	\$12. ⁹⁵ EA
72	MP-8-P	\$12. ⁹⁵ EA
73	MP-9-P	\$12. ⁹⁵ EA

GENERAL LIBRARY

HOW TO RESTORE YOUR MUSTANG



Good fundamental ground up guide, showing step by step procedures for 1965 - 1968 Mustangs. This has been the best seller for several years. Easy to read, shows numerous photographs. Also contains color charts for exterior, upholstery, convertible tops, vinyl tops, and carpet.

Year	Part No.	List
65-68	L-61	\$14.95 EA

HOW TO RESTORE YOUR MUSTANG: 1964 - 1973



This restorer's manual provides clear, concise information in an easy-to-follow format for restoring your car. In addition, it includes information to keep the restorer on track and the project within budget. The book includes step-by-step restoration procedures so owners and restorers can confidently complete each job. 192 pages, and includes more than 400 color photos.

Year	Part No.	List
64-73	SA-165	\$29.95 EA

VOLUME 1 MUSTANG HOW TO



This is Vol. 1 of a two part series. Contains 25 "How To" instruction articles. You'll find answers and instructions to the 25 most asked Mustang questions. "How To" improve handling, repair leaking cowl panels, remedy sloppy shifters, replace a convertible top, and "How To" replace a headliner, plus much, much more.

Year	Part No.	List
64-73	L-72	\$13.95 EA

VOLUME 2 MUSTANG HOW TO



This is Vol. 2 of the ever popular "How To" instruction articles. Talks about the following: rebuild a toploader, install a Rally Pac, add front disc brakes, replace vinyl tops, replace carpet, plus much, much more.

Year	Part No.	List
64-73	L-74	\$13.95 EA

HOW TO PAINT YOUR MUSTANG



This is a step by step procedure manual designed for first time painters. Discusses cleaning, disassembly, body preparation, painting techniques, equipment, reassembly, paint codes and stripes.

Year	Part No.	List
64-73	L-70	\$14.95 EA

MUSTANG RESTORATION TIPS & TECHNIQUES



Compiled from Hot Rod Magazine. Features lots of how to's, sheet metal repairs, doors, interiors, flares, engine blueprinting, transmissions, suspension swaps, buying used, rust & dent repairs plus painting. 163 pages, 100+ illustrations. Soft bound.

Year	Part No.	List
64-73	111084AE	\$19.95 EA

MUSTANG RESTORATION HANDBOOK



Great overall coverage of entire vehicle. Features articles on history, how to buy used, disassembly, suspension, steering, brakes, engine, body, paint, interior, convertible top plus much more. 176 pages, 500 illustrations. Soft bound.

Part No.	Year	List
HP-029	65-70	\$24.95 EA

HOW TO REBUILD YOUR SMALL BLOCK FORD ENGINE



This book covers all the necessary steps in rebuilding a long block. 260, 289, 302, 351W

Year	Part No.	List
64-73	HP-89	\$24.95 EA

HOW TO REBUILD YOUR FORD BIG BLOCK



This book covers all the necessary steps in rebuilding a long block. 360, 390, 427, 428

Year	Part No.	List
67-73	HP-708	\$24.95 EA

351M, 400, 429 AND 460 HOW TO REBUILD YOUR FORD 8 CYLINDER



This book covers all the necessary steps in rebuilding a long block.

Year	Part No.	List
64-73	HP-36	\$24.95 EA

HOW TO BUILD AND MODIFY YOUR C4 AND C6 TRANSMISSION



Everything you need to know about the C4 and C6 Automatic Transmissions.

Year	Part No.	List
64-73	SA227	\$24.95 EA

BOSS 302 ENGINE MODIFICATIONS



Reprints of original Ford brochures. Great for beefing up the Boss 302. Approximately 30 pages each. Soft bound.



Part No.	Year	List
MP-10	69-70	\$7.95 EA

BOSS 302 CHASSIS MODIFICATIONS



Reprints of original Ford brochures. Great for beefing up the Boss 302. Approximately 30 pages each. Soft bound.



Year	Part No.	List
69-70	MP-11	\$7.95 EA

1969-2012 BOSS 302 BOOK



Complete detailed history of production and racing. Written by Donald Farr a must for any Boss 302 owner.



Year	Part No.	List
69-12	L-71	\$25.95 EA

BOSSSES: 302, 351, 429



Spans from 1969 - 1971. Covers specs, features, construction and much more. Copies from original sales literature. 30 pages. Soft bound.

Year	Part No.	List
69-71	MP-25	\$8.95 EA

WE PROUDLY FEATURE AUTHENTIC MUSTANG REPRODUCTIONS FROM SCOTT DRAKE!



MUSTANG FACT BOOK

Originally printed to provide Ford's sales force with adequate product knowledge. Today's usage is numerous. Contains information on production, performance, economy, competition, accessories and prices.



Year	Part No.	List
64	MP-291	\$6 ⁹⁵ EA
65	MP-292	\$6 ⁹⁵ EA
66	MP-293	\$6 ⁹⁵ EA
67	MP-294	\$6 ⁹⁵ EA
68	MP-295	\$6 ⁹⁵ EA
69	MP-296	\$6 ⁹⁵ EA
69	MP-297	\$6 ⁹⁵ EA
71	MP-298	\$6 ⁹⁵ EA
72	MP-299	\$6 ⁹⁵ EA
73	MP-300	\$6 ⁹⁵ EA

POCKET SIZE DATA PLATE DECODER

It's easy to use, and pocket size. Perfect for checking patent data plates and warranty number plate. Covers 1964 - 1973.

Year	Part No.	List
65-73	L-64	\$10 ⁹⁵ EA

FORD HIGH PERFORMANCE PARTS IDENTIFIER

Now it's easy to authenticate any high performance engine. Describes casting, numbers on engines, engine components, transmission, and differential. 88 pages. Also features information on building and restoring a 289 HiPo. By Robert Winkelman.

Year	Part No.	List
63-73	L-68	\$9 ⁹⁵ EA

MUSTANG BY THE NUMBERS MUSTANG PRODUCTION BOOK

Mustangs by the numbers. This new book features production facts on the 1967 - 1973 Mustang. The author obtained the entire production database from the Ford Motor Company under license. This book contains over 12,000 statistics. Did you know only 1 1967 fastback was painted Diamond Green?

Year	Part No.	List
67-73	MB-101	\$28 ⁹⁵ EA

THE MUSTANG AND COUGAR TAGBOOK

This book has everything you need to know for deciphering the codes on all the mysterious tags found on your Mustang or Cougar (1965-73 Models).

Part No.	Year	List
MB-102	65-73	\$29 ⁹⁵ EA

THE DEFINITIVE SHELBY MUSTANG BOOK

Each year of Shelby Mustang production is isolated and examined in-depth, with explicit descriptions of how these great cars came to be. The various options, modifications, and upgrades are shared in full, with intriguing behind-the-scenes facts and documented issues on full display. The problem Shelby faced and conquered makes the final products all the more interesting and atypical of other limited production automobiles.

Year	Part No.	List
65-73	CT507	\$34 ⁹⁵ EA

RARE FINDS MUSTANGS AND FORDS

Rare Shelby, Boss, Cobra Jet Mustangs. And high performance Fords have been residing in automotive cocoons...holed up in barns, storage buildings, garages, and other nook and crannies. As the automotive Indiana Jones, Jerry Heasley has been tracking down and capturing stories of the rarest and most valuable and sought-after Mustangs and high-performance Fords for more than 25 years.

Year	Part No.	List
65-73	CT509	\$24 ⁹⁵ EA

HIGH PERFORMANCE PARTS

This 38 page paperback booklet covering big block modification for power and performance. Also has a listing of Autolite-Ford Hi-Per parts available through Ford and Lincoln-Mercury dealers.

Year	Part No.	List
61-80	MP-42	\$14 ⁹⁵ EA

ACCESSORY PRICE GUIDE

These neat little booklets show original cost of options and accessories. Used by dealers to figure out cost for special order cars.



Year	Part No.	List
65	DF-55	\$2 ⁹⁵ EA
66	DF-56	\$2 ⁹⁵ EA
67	DF-97	\$2 ⁹⁵ EA
68	DF-98	\$2 ⁹⁵ EA
68	DF-258	\$2 ⁹⁵ EA
69	DF-99	\$2 ⁹⁵ EA
73	DF-103	\$2 ⁹⁵ EA

MUSTANG RECOGNITION GUIDE

A full 226-pages of the Mustang history year by year. Hundreds of color photographs. A detailed study of interior and exterior. Also includes Shelby and California special.



Year	Part No.	List
64-73	L-69	\$23 ⁹⁵ EA

SHOP WITH CONFIDENCE! WE OFFER SUPERIOR-QUALITY PARTS FOR ALL YOUR MUSTANG RESTORATION NEEDS.

MIRRORS

INSIDE REAR VIEW MIRRORS

1964-66 MUSTANG DAY/NIGHT MIRRORS WITH FOMOCO LOGO



Officially Licensed by Ford, Scott Drake's 1964-65 and 1965-66 Mustang Day/Night Mirrors are made as the original with the backside ribbed area painted silver and the FoMoCo logo stamped on back of the mirror housing. Featuring correct Day/Night markings on the knob and show quality chromed steel and glass, this mirror is a must for concours restoration.



Year	Description	Part No.	List
64-65	Push Button Day/Night w/ FoMoCo logo	CSZZ-17700-FMC	\$38.95 EA
65-66	Twist Day/Night w/ FoMoCo logo	C6ZZ-17700-FMC	\$38.95 EA

REAR VIEW MIRROR

Exact copies, with all the right details. Improved mirror with superior quality crimping of frame to glass.



64-66: Show quality
CSZZ-17700-A

List
\$18.95 EA



64-65: Day/Night push button.
Economy
CSZZ-17700-B

List
\$28.95 EA



65-66: Day/Night turn button.
Economy
C6ZZ-17700-A

List
\$28.95 EA



67: Day/Night
C7ZZ-17700-A

List
\$39.95 EA



68-69: Day/Night, concours
C7AZ-17700-G

List
\$53.95 EA



68-70: Day/Night, aftermarket
C8AZ-17700-A

List
\$29.95 EA

REAR VIEW MIRROR AND ARM KIT



Save money with this quite attractive new kit. Includes standard mirror and our pressure die cast arm.

Year	Part No.	List
64-66	KIT-MIR-1	\$34.95 KI

REAR VIEW MIRROR MOUNT



Special cast-metal bracket glues to windshield. Plain finish. Exact detail. 68-69 pictured.

Year	Part No.	List
68-69	C8AZ-17698-A	\$7.95 EA
70-79	C9AZ-17698-A	\$2.95 EA

REAR VIEW MIRROR ARM

Pressure die cast, with quality chrome. Replaces one of the most visible interior parts.



68-69: Satin
C2SZ-17690-F

List
\$15.95 SE



64-66: Concours chrome
CSZZ-17690-D

List
\$15.95 EA



67: Concours 2-piece design
C7ZZ-17690-A

List
\$24.95 EA

OUTSIDE MIRRORS

1964-66 MUSTANG CONCOURS OUTSIDE MIRRORS



Scott Drake Show-Quality Mustang Mirrors are the best on the market! Our mirrors feature flawless chrome, perfect details and a perfect fit. These mirrors fit both RH and LH side, but we recommend our convex glass mirrors for the RH side for a greater field of vision. Available in 2 finishes for an original or custom look: chrome, or satin chrome. All Scott Drake mirrors come complete with a new base pad and mounting screws. We now offer a long C3RZ base for a custom look on 67-73, also an ideal way to cover-up pre-existing holes from an incorrect mirror on 64-66.

Year	Desc	Part No.	List
64-66	Chrome	C3RZ-17696-R	\$45.95 EA
64-66	Satin chrome	C3RZ-17696-RS	\$49.95 EA
64-66	Satin chrome w/ convex glass	C3RZ-17696-CS	\$52.95 EA
64-66	Chrome w/long base	C3RZ-17696-LB	\$48.95 EA
64-66	Chrome w/ convex glass	C3RZ-17696-C	\$48.95 EA

1967-73 MUSTANG CONCOURS OUTSIDE MIRRORS



These outside mirrors feature flawless chrome and a perfect fit. Mirrors fit both left and right hand side, but we recommend our mirrors with convex glass for the right hand side because they have a greater field of vision. All mirrors come with base pad and mounting screw

Year	Desc	Part No.	List
67-73	Chrome, long base, concours	C7AZ-17696-A	\$48.95 EA
67-73	Chrome, long base w/ convex glass	C7AZ-17696-C	\$52.50 EA
70-73	Chrome, short base	D1ZZ-17696-A†	\$49.95 EA
67-73	Satin chrome	C7AZ-17696-AS	\$49.95 EA
67-73	Satin chrome w/ convex glass	C7AZ-17696-CS	\$52.95 EA

WE PROUDLY FEATURE AUTHENTIC MUSTANG REPRODUCTIONS FROM SCOTT DRAKE!



1964-66 ECONOMY OUTSIDE MIRROR



A nice reproduction with a quality chrome finish, but available at a lower price. Great for daily drivers or restorers on a budget.

Year	Description	Part No.	List
64-66	Economy	C3RZ-17696-A	\$27.95 ^{EA}

OUTSIDE MIRROR BASE PAD



Black molded plastic which has a bead around perimeter just like the original.

Part No.	Year	Description	List
C3RZ-17724-A	64-66		\$2.95 ^{EA}
C7ZZ-17724-A	67-68		\$2.50 ^{EA}
C5ZZ-17724-A	64-66	Remote	\$2.50 ^{EA}
C9ZZ-17724-A	69-70	Racing	\$9.95 ^{PR}
D1ZZ-17724	71-73	Racing	\$7.50 ^{EA}
S1MS-17724	65-66	Shelby bullet	\$15.95 ^{EA}

OUTSIDE MIRROR MOUNTING KIT



These simple kits are an easy solution to oversized screw holes (or missing nuts on 67-73 Mustangs).

Year	Description	Part No.	List
64-66	Standard	C3RZ-17696-MK	\$2.95 ^{KI}
64-66	Remote	C5ZZ-17696-MK	\$2.95 ^{KI}
67-73	All	C7AZ-17696-MK	\$2.95 ^{KI}

INSIDE REAR VIEW MIRROR ADHESIVE



Remounts rearview mirror bracket to windshield permanently. Mounting strength is 300 psi. Unaffected by hot and cold temperature variation.

Supplied in 0.04 ounce tube.

Part No.	Year	List
PRO-61067	64-73	\$5.95 ^{EA}

RACING MIRRORS



Show car quality. Exact copy of Rotunda mirror offered years ago. Includes pads, mounting hardware and positioning templates. Long base utilizes 64-66 C3RZ mounting holes

Year	Description	Part No.	List
64-68	Bullet, show-quality	C5RZ-17696-A	\$99.95 ^{EA}
64-68	Bullet, show quality, convex	C5RZ-17696-B	\$99.95 ^{EA}

64-68	Bullet, long base	C5RZ-17696-AL	\$99.95 ^{EA}
64-68	Bullet, long base, convex	C5RZ-17696-ALC	\$99.95 ^{EA}

69	Early 69, LH remote	C9ZZ-17696-C	\$134.95 ^{EA}
69-70	Late 69, LH remote	C9ZZ-17696-L	\$134.95 ^{EA}
69-70	RH	C9ZZ-17696-R	\$129.95 ^{EA}

71-73	Remote, LH	D1ZZ-17696-L	\$134.95 ^{EA}
71-73	RH	D1ZZ-17696-R	\$129.95 ^{EA}

RH SPORT MIRROR CONVEX GLASS



A New by Scott Drake is our 1969-73 Mustang Convex Sports Mirror Glass. Our convex mirror glass is designed to be used

on right hand (passenger side) sports mirrors to help eliminate the blind spot associated with original flat glass. The mirror glass can be installed directly over the original mirror glass. This will allow for removal of the convex glass if you want to return the Sports mirror back to its original state. Note: will not fit left hand (drivers side) mirrors.

Part No.	Year	List
C9ZZ-17696-CNVX	69-73	\$14.95 ^{EA}

SPORT MIRROR BEZEL NUT



A nice reproduction.

Year	Part No.	List
69	C6GY-17B719-A	\$18.95 ^{EA}
70-71	C9TZ-17B732-A	\$21.95 ^{EA}

REMOTE MIRROR BEZEL



A nice reproduction of the inner door Remote Mirror Bezel.

Year	Part No.	List
69	C8SZ-17B733-B	\$19.95 ^{EA}

REMOTE MIRROR MIRRORS



Super quality mirror by Scott Drake. These are superior to anything on the market. Features the highest quality chrome finish. Pad and mounting hardware

included. Made in the USA with pride. Show quality. Also available with convex glass for improved view.

Year	Description	Part No.	List
64-66	LH, economy, imported	C5ZZ-17696-A	\$56.95 ^{EA}
64-66	LH, Show-Quality	C5ZZ-17696-BR	\$69.95 ^{EA}
64-66	LH, Rotunda logo, Concours Show-quality	C5ZZ-17696-LR	\$94.95 ^{EA}

REMOTE CONTROL MIRRORS

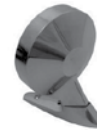

Year	Description	Part No.	List
64-66	RH, show-quality, "dummy remote"	C5ZZ-17696-R	\$69.95 ^{EA}
64-66	RH, convex, "dummy remote"	C5ZZ-17696-CR	\$84.95 ^{EA}
64-66	RH, Rotunda logo, "dummy remote", Concours Show-quality	C5ZZ-17696-RR	\$84.95 ^{EA}



Year	Description	Part No.	List
67-68	RH, concours, "dummy remote"	C8AZ-17696-AR	\$84.95 ^{EA}
67-68	RH, convex, "dummy remote"	C8AZ-17696-CR	\$84.95 ^{EA}



Year	Description	Part No.	List
67-68	LH, economy, imported	C7AZ-17696-E†	\$54.95 ^{EA}
67	LH, concours	C7AZ-17696-ER	\$89.95 ^{EA}
67	LH, convex	C7AZ-17696-ERC	\$94.95 ^{EA}
68	LH, concours	C8AZ-17696-ER	\$89.95 ^{EA}

MUSTANG MIRRORS WITH LED INDICATORS



Scott Mustang Deluxe Remote Mirror Kits with LED indicators! Modern

cars have LED indicators built into both mirrors for safety. Classic cars and especially Mustangs have a lower profile than most modern cars. Make sure that your car is noticed when you change lanes with our new LED turn signal indicating mirrors. This safety feature helps prevent side collision accidents by giving cars in your blind spot plenty of warning if you need to change lanes. The LED Mirrors are made with our Show Quality Reproductions and look factory correct. Superbly detailed to pass even the most critical inspection. RH side is also made using Convex glass to improve your field of vision. Equipped with patented electronics these reliable LED turn signal indicators blink only when they are supposed to which is when you activate your turn signals not when you hit the brakes like all other kits. Super simple hook up in to existing turn signal wiring with NO special or complicated control boxes to worry.

Year	Desc	Part No.	List
64-66	Remote Mirrors w/ LED indicators	C5ZZ-17696-LED	\$299. ⁹⁵ PR
67-68	Remote Mirrors w/ LED indicators	C7AZ-17696-LED	\$299. ⁹⁵ PR

MOLDING

HOOD MOLDING

 For the front of the hood, to trim the edge. 1964-70 versions are formed from aluminum, as the originals were.

Year	Description	Part No.	List
64-66	Reproduction	C5ZZ-16856-A	\$17. ⁹⁵
64-66	Original Tooling	C5ZZ-16856 ¹	\$54. ⁹⁵ EA
67-68		C7ZZ-16856-A	\$18. ⁵⁰ EA
69		C9ZZ-16856-A	\$27. ⁹⁵ EA
70		D0ZZ-16856-AR	\$29. ⁹⁵ EA
71-72	Chrome	D1ZZ-16856-A	\$124. ⁹⁵ EA
71-73	Ready to paint	D1ZZ-16856-B	\$84. ⁹⁵ EA

HOOD MOLDING SUPPORT

 Hood molding attaches to this commonly damaged or missing part.

Year	Part No.	List
70	D0ZZ-16C694	\$34. ⁹⁵ EA

FENDER EXTENSION MOLDING



Year	Description	Part No.	List
70	RH	D0ZZ-16074	\$84. ⁹⁵ EA
70	LH	D0ZZ-16075	\$84. ⁹⁵ EA

FRONT FENDER EXTENSION MOLDING



Features die-cast zinc construction.

Year	Description	Part No.	List
71-72	Chrome	D1ZZ-16160/1	\$92. ⁵⁰ PR
71-72	Paint to match	D1ZZ-16160-B	\$84. ⁵⁰ PR
73	Paint to match	D3ZZ-16160/1	\$94. ⁹⁵ PR

GRILLE MOLDING AND TRIM



Fits on outside of grill opening. 64-70 molding includes mounting hardware. For all 71-73 molding, mounting clips are sold separately.

Year	Description	Part No.	List
64-66	RH, wide	C5ZZ-8242-AR	\$19. ⁹⁵ EA
64-66	LH, wide	C5ZZ-8243-AR	\$19. ⁹⁵ EA
67-68	RH, wide	C7ZZ-8190-AR	\$33. ⁹⁵ EA
67-68	LH, wide	C7ZZ-8191-AR	\$33. ⁹⁵ EA
67-68	RH, narrow	C7ZZ-8242-AR	\$16. ⁹⁵ EA
67-68	LH, narrow	C7ZZ-8243-AR	\$16. ⁹⁵ EA
69	Lower grille panel	C9ZZ-8221-A	\$71. ⁹⁵ EA
69	RH, wide	C9ZZ-8242-AR	\$45. ⁹⁵ EA
69	LH, wide	C9ZZ-8243-AR	\$45. ⁹⁵ EA
69	RH, narrow	C9ZZ-8242-BR	\$45. ⁹⁵ EA
69	LH, narrow	C9ZZ-8243-BR	\$45. ⁹⁵ EA
69	Center, narrow	C9ZZ-8419-AR	\$18. ⁹⁵ EA
70	Center, wide, Lower	D0ZZ-8221-A	\$72. ⁵⁰ EA
71-72	Upper or lower	D1ZZ-8419-B	\$32. ⁹⁵ EA
71-72	RH	D1ZZ-8419-C	\$32. ⁹⁵ EA
71-72	LH	D1ZZ-8419-E	\$32. ⁹⁵ EA
73	RH	D3ZZ-8242-A	\$32. ⁹⁵ EA
73	LH	D3ZZ-8243-A	\$32. ⁹⁵ EA
73	Upper or lower	D3ZZ-8419-C	\$32. ⁹⁵ EA

GRILLE MOLDING CENTER JOINT COVER

Chrome is better than original, recessed area is painted Argent Silver. All necessary fasteners are included. 67-68 versions features polished aluminum with argent silver recessed areas.



66: Center
C6ZZ-8221-A

List
\$13.⁹⁵ EA

67-68: Center Joint Cover
C7ZZ-8221-AR

List
\$12.⁹⁵ EA

MOLDING RETAINER CLIP

Exact OEM replacements. Plated to stop corrosion.



64-65
C5ZZ-65423A26-A

List
\$0.⁴⁰ EA



66-73
C5ZZ-65423A26-B

List
\$0.³⁵ EA



67-68: Coupe top rear molding only
C7ZZ-65423A26-A

List
\$0.90 EA



69-70: Windshield stops (screws included)
C8AZ-6203012-A

List
\$9.⁹⁵ PR



69-70: Lower windshield molding
C9ZZ-6503406-A

List
\$3.²⁵ EA

Molding

WE PROUDLY FEATURE AUTHENTIC MUSTANG REPRODUCTIONS FROM SCOTT DRAKE!



WINDSHIELD MOLDINGS



These formed stainless steel moldings are a good

reproduction at an economical price. They are polished like the originals.

Year	Description	Part No.	List
64-68	CP/FB, 5 piece kit	C5ZZ-6503136/48	\$114. ⁹⁵ SE
64-68	Side, RH	C5ZZ-6503136-BR	\$20. ⁹⁵ EA
64-68	Side, LH	C5ZZ-6503137-BR	\$20. ⁹⁵ EA
64-68	Top, RH	C5ZZ-6503144-BR	\$21. ⁹⁵ EA
64-68	Top, LH	C5ZZ-6503145-BR	\$21. ⁹⁵ EA
64-68	Lower	C5ZZ-6503148-BR	\$34. ⁹⁵ EA
69-70	Fastback, 5 piece kit	C9ZZ-630313448K	\$169. ⁹⁵ SE
69-70	Coupe, 5 piece kit	C9ZZ-650313648K	\$174. ⁹⁵ SE
71-73	Coupe, 2 piece	D1ZZ-650313648K	\$174. ⁹⁵ SE

CONVERTIBLE WINDSHIELD PILLAR MOLDING



Stainless steel, outer windshield pillar moldings for convertibles. Includes right and left hand side. Daily driver quality to replace

missing or damaged originals.

Year	Part No.	List
64-68	C5ZZ-7603136/7B	\$110. ⁹⁵ PR

WINDSHIELD FILLER PANEL



These moldings fill the gap between the windshield and the padded dash.

Year	Description	Part No.	List
67-68	2 piece filler molding	C7ZZ-6504522/3A	\$57. ⁹⁵ EA

DRIP RAIL MOLDING



Stainless steel stamped moldings that attach to drip rail or roof rail. Economy moldings to replace damaged or missing originals.

Year	Description	Part No.	List
65-66	Fastback	C5ZZ-6351726/7A	\$72. ⁵⁰ PR
64-68	Coupe	C5ZZ-6551726/7A	\$72. ⁵⁰ PR
67-68	Fastback	C7ZZ-6351726/7A	\$86. ⁹⁵ PR
69-70	Fastback	C9ZZ-6351726/7A	\$84. ⁹⁵ PR
69-70	Coupe w/out vinyl top	C9ZZ-6551726/7A	\$89. ⁹⁵ PR

DRIP RAIL SASH MOLDING



Part No.	Year	Desc	List
C5ZZ-63517A10/1	65-66	Fastback	\$159. ⁹⁵ PR
C7ZZ-63517A10/1	67-68	Fastback	\$164. ⁹⁵ PR

FASTBACK DRIP RAIL



Steel drip channel that was originally spot welded to body.

Part No.	Year	Description	List
C9Z-6351726/7A	69-70	Fastback, Steel drip channel that s/s molding snaps onto	\$192. ⁵⁰ PR

DRIP RAIL MOLDING JOINT COVER



Pressure die cast like original and chrome plated. Fastback only.

Year	Part No.	List
69-70	C9ZZ-6351828/9A	\$34. ⁹⁵ PR

QUARTER PANEL ORNAMENT



Fine reproductions to ensure you of the finest quality, fit, and appearance.

Year	Description	Part No.	List
64-65	Concours	C5ZZ-65290A76/7	\$34. ⁹⁵ PR

QUARTER PANEL ORNAMENT



Fine reproductions to ensure you of the finest quality, fit, and appearance.

Year	Description	Part No.	List
66	Concours	C6ZZ-65290A76/7	\$44. ⁹⁵ SE
66	Satin	C6ZZ-65290A76/7S	\$44. ⁹⁵ SE

QUARTER PANEL ORNAMENT



67: Set of 4
C7ZZ-65291A52/3

List
\$129. ⁹⁵ SE



68: Chrome trim
C8ZZ-65290A767A

List
\$75. ⁹⁵ PR



68: Base, paint to match
C8ZZ-65290C82/3

List
\$69. ⁹⁵ PR



69
C9ZZ-65290D14/5

List
\$124. ⁹⁵ PR

QUARTER WINDOW MOLDING



Pressure die cast like original and chrome plated. USA version is made from Original Ford Tooling.

Year	Description	Part No.	List
69-70	Fastback - USA Made	C9ZZ-6329796/7A	\$124. ⁹⁵ PR
69-70	Fastback - Imported	C9ZZ-6329796/7I	\$84. ⁹⁵ PR

QUARTER WINDOW TRIM



Pressure die cast like original and chrome plated.

Year	Description	Part No.	List
69-70	Coupe	C9ZZ-6529796/7	\$84. ⁹⁵ PR

FASTBACK DOOR GLASS MOLDING



Beautiful reproduction. Made from the original Ford Tooling. Made from rust proof 304 stainless steel.

Attaches to back of door glass. Rubber seal sold separately.

Year	Description	Part No.	List
69-70	Fastback, RH	D0ZZ-6322220-A+	\$59. ⁹⁵ EA
69-70	Fastback, LH	D0ZZ-6322221-A+	\$59. ⁹⁵ EA



VINYL TOP MOLDING



Pressure die cast construction and chrome plated.

Year	Part No.	List
65-66	C5ZZ-65423A18/9	\$64. ⁹⁵ PR
67-68	C7ZZ-65423A18/9	\$69. ⁹⁵ PR

VINYL TOP



Year	Description	Part No.	List
64-70	Black	VT-65-BK	\$164. ⁹⁵ EA
64-70	White	VT-65-WT	\$164. ⁹⁵ EA

REAR WINDOW MOLDING KIT



This is just the kit to replace that dented, scratched or missing rear window trim on your Mustang.

Year	Description	Part No.	List
65-66	Fastback, 4 piece kit	C5ZZ-6342404	\$94. ⁹⁵ KI
64-66	Coupe, 6 piece kit	C5ZZ-6542404	\$84. ⁹⁵ KI
67-68	Fastback, 6 piece kit	C7ZZ-6342404	\$104. ⁹⁵ KI
67-68	Coupe, 4 piece kit	C7ZZ-6542404	\$184. ⁹⁵ SE
69-70	Fastback, 4 piece kit	C9ZZ-6342404	\$64. ⁹⁵ KI
71-73	Fastback	D1ZZ-6342404	\$199. ⁹⁵ EA

ROCKER MOLDING



Aluminum stampings, highly polished with a great fit. 64-69 moldings come with attaching hardware.

Year	Description	Part No.	List
64-66		C5ZZ-6510176/7A	\$98. ⁹⁵ KI
67-68		C7ZZ-6510176/7	\$88. ⁹⁵ KI
69		C9ZZ-6510176/7	\$116. ⁹⁵ PR
70	Mach 1, concours	D0ZZ-6320938KIT	\$259. ⁹⁵ KI
71-73		D1ZZ-6510176/7	\$139. ⁹⁵ PR

MOLDING HARDWARE



We offer these complete hardware kits for your customer's convenience. Kits include high strength

backing plates and all necessary screws, clips, or rivets.

Year	Description	Part No.	List
64-66	Left or right	C5ZZ-6510182-K	\$18. ⁹⁵ KI
67-68	LH	C7ZZ-6510182-KL	\$18. ⁹⁵ KI
67-68	RH	C7ZZ-6510182-KR	\$18. ⁹⁵ KI

WHEEL OPENING MOLDING



Our wheel opening moldings are roll-formed aluminum, just like the originals. Mounting screws are included with these moldings.

Year	Description	Part No.	List
67-68	Front, RH	C7ZZ-16038-B	\$20. ⁹⁵ EA
67-68	Front, LH	C7ZZ-16039-B	\$20. ⁹⁵ EA
67-68	Rear, RH	C7ZZ-6529164-A	\$20. ⁹⁵ EA
67-68	Rear, LH	C7ZZ-6529165-A	\$20. ⁹⁵ EA
69	Front, RH	C9ZZ-16038-B	\$21. ⁹⁵ EA
69	Front, LH	C9ZZ-16039-B	\$21. ⁹⁵ EA
69	Fastback, rear, RH	C9ZZ-6329164-A	\$21. ⁹⁵ EA
69	Fastback, rear, LH	C9ZZ-6329165-A	\$21. ⁹⁵ EA
69	Coupe/convertible, rear, RH	C9ZZ-6529164-A	\$21. ⁹⁵ EA
69	Coupe/convertible, rear, LH	C9ZZ-6529165-A	\$21. ⁹⁵ EA
70	Front, RH	D0ZZ-16038-B	\$21. ⁹⁵ EA
70	Front, LH	D0ZZ-16039-B	\$21. ⁹⁵ EA
70	Fastback, rear, RH	D0ZZ-6329164-A	\$20. ⁹⁵ EA
70	Fastback, rear, LH	D0ZZ-6329165-A	\$20. ⁹⁵ EA
70	Coupe/convertible, rear, RH	D0ZZ-6529164-A	\$20. ⁹⁵ EA
70	Coupe/convertible, rear, LH	D0ZZ-6529165-A	\$20. ⁹⁵ EA
71-73	Front, RH	D1ZZ-16038-AR	\$33. ⁹⁵ EA
71-73	Front, LH	D1ZZ-16039-AR	\$33. ⁹⁵ EA
71-73	Rear, RH	D1ZZ-6529164-AR	\$33. ⁹⁵ EA
71-73	Rear, LH	D1ZZ-6529165-AR	\$33. ⁹⁵ EA

WHEEL OPENING MOLDING KIT



Although not an original option, this kit is very popular. Our wheel opening moldings are roll-formed aluminum, just like the 67-73 versions. Mounting screws included. All 4 moldings included in kit.

Year	Description	Part No.	List
64-66		C5ZZ-16038-KIT	\$104. ⁹⁵ KI

TAIL LIGHT PANEL MOLDING

Polished aluminum moldings which fit on the honey comb optional panel. Please see sheetmetal section for honeycomb panel. Will fit on all body styles for 1970 but is original for Mach 1 only.

Year	Description	Part No.	List
70	3 piece kit	D0ZZ-63423A82/4	\$104. ⁹⁵ PR
71-73	2 piece kit	D1ZZ-63423A82/4	\$99. ⁹⁵ PR

TAIL LIGHT PANEL MOLDING CLIPS



These 12 special retaining clips are used to mount the Tail Lamp Panel Moldings on all 70-73 Mach 1's.

Year	Part No.	List
70-73	D0GY-65291B80-A	\$19. ⁹⁵ ST

TAIL LIGHT HONEYCOMB PANEL



All new tooling, this panel is made from high quality ABS plastic injection.

Year	Description	Part No.	List
70	Dark Argent	D0ZZ-63423B70	\$104. ⁹⁵ EA
71-73	Black	D1ZZ-63423B70	\$110. ⁰⁰ EA

TRUNK MOLDING

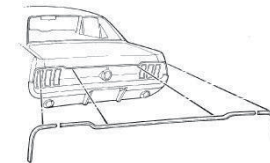

Brightly polished aluminum moldings that are easy to install. All moldings come with attaching hardware.

Year	Description	Part No.	List
67-68	FB, RH quarter extension trim	C7ZZ-6329078-A	\$14. ⁹⁵ EA
67-68	FB, LH quarter extension trim	C7ZZ-6329078-A	\$14. ⁹⁵ EA
67-68	FB, trunk trim	C7ZZ-6342512-A	\$19. ⁹⁵ EA
67-68	CP/CV, RH quarter extension trim	C7ZZ-6529078-A	\$15. ⁹⁵ EA
67-68	CP/CV, LH quarter extension trim	C7ZZ-6529079-A	\$15. ⁹⁵ EA
67-68	CP/CV, trunk trim	C7ZZ-6542512-A	\$35. ⁹⁵ EA
69-70	CP/CV, RH quarter extension trim	C9ZZ-6529078-A	\$29. ⁹⁵ EA
69-70	CP/CV, LH quarter extension trim	C9ZZ-6529079-A	\$29. ⁹⁵ EA
69-70	CP/CV, trunk trim	C9ZZ-6542512-A	\$69. ⁹⁵ EA

WE PROUDLY FEATURE AUTHENTIC MUSTANG REPRODUCTIONS FROM SCOTT DRAKE!



PAINTS & TOOLS

ACCUMATCH™ ENGINE PAINTS



AccuMatch™ Engine Paints are a complete line of popular colors and formulas created specifically for engine compartment applications.

Engine paints come with higher heat tolerances to resist cracking and flaking, and are chemical resistant to resist corrosion from common engine compartment fluids such as gasoline. Formulated to color-match original OEM shades. Withstands temperatures up to 350° F.

Year	Description	Part No.	List
65	V8, black	EP-1724-A	\$8.50 ^{EA}
66-73	Dark blue	EP-1923-A	\$8.50 ^{EA}
70-73	Light blue	EP-0046-A	\$8.50 ^{EA}
65	6 cyl., red	EP-1001-A	\$8.95 ^{EA}
64-65	Gold- similar to original gold color	EP-1005-A	\$8.50 ^{EA}

ACCUMATCH™ INTERIOR PAINTS



The AccuMatch(TM) Interior Paints are the result of years of work and perfectly match the original color shades. Each color has been expertly color-matched.

Paints feature extra-high pigment content for superior coverage, and patented fan-pattern nozzle for professional results.

Year	Description	Part No.	List
67-68	Dark blue, metallic	L-5770	\$14.50 ^{EA}
68	Dark red, metallic	L-5732	\$14.50 ^{EA}
69	Dark red, metallic	L-15641	\$14.50 ^{EA}
68	Dark red	L-5792	\$14.50 ^{EA}
69	Dark red	L-15847	\$14.50 ^{EA}
70	Vermillion	L-15945	\$14.50 ^{EA}
71-73	Medium vermillion, metallic	L-16050	\$14.50 ^{EA}
67-68	Dark aqua, metallic	L-5753	\$14.50 ^{EA}
70	Ivy green, metallic	L-15942	\$14.50 ^{EA}
73	Medium avocado	L-17023	\$14.50 ^{EA}
67	Dark gold, metallic	L-5734	\$14.50 ^{EA}
69	Dark ivy, metallic	L-15644	\$14.50 ^{EA}
69	Dark ivy	L-15854	\$14.50 ^{EA}
64-66	Medium ivy gold, metallic	L-5756	\$14.50 ^{EA}
70-73	Dark ginger	L-15940	\$14.50 ^{EA}
67-68	Dark saddle	L-5738	\$14.50 ^{EA}
67-68	Saddle, semi gloss	L-5739	\$14.50 ^{EA}
64-65	Med palomino, metallic	L-5759	\$14.50 ^{EA}
64-65	Light palomino	L-17690	\$14.50 ^{EA}
68	Dark nug gold, metallic	L-5798	\$14.50 ^{EA}
68-69	Light nug gold, metallic	L-5800	\$14.50 ^{EA}
66	Med emberglow, metallic	L-5777	\$14.50 ^{EA}

Year	Description	Part No.	List
64-66	Black, semi gloss	L-946	\$10.95 ^{EA}
67-73	Black charcoal	L-4464	\$10.95 ^{EA}
66-67	Dark red, metallic	L-5773	\$10.95 ^{EA}
64-65	Bright red, semi gloss	L-6022	\$10.95 ^{EA}
64-70	Medium blue, metallic	L-5747	\$10.95 ^{EA}
71-73	Medium blue, metallic	L-16049	\$10.95 ^{EA}
65-69	Light blue, metallic	L-5748	\$10.95 ^{EA}
65-66	Light aqua, metallic	L-5752	\$10.95 ^{EA}
64-66	Light ivy gold, metallic	L-5760	\$10.95 ^{EA}
67-68	Light ivy gold, metallic	L-5778	\$10.95 ^{EA}
70-73	Ginger, semi gloss	L-15939	\$10.95 ^{EA}
1966	Parchment, semi gloss	L-5779	\$10.95 ^{EA}
67-68	Light parchment	L-4595	\$10.95 ^{EA}
64-66	White, semi gloss	L-5767	\$10.95 ^{EA}
69-73	White, semi gloss	L-15855	\$10.95 ^{EA}

ACCUMATCH™ DETAIL BLACK PAINT



AccuMatch™ Detail Black is formulated with a correct 15% semi-gloss finish to match original OEM shades, and it's extra-high pigment content provides

superior coverage over similar paints. Ideal for pulleys, brackets, engine aprons and most other underhood/chassis components. Provides extra protection against rust and corrosion to help prolong the life of your vehicle's valuable components.

Year	Description	Part No.	List
64-73	OEM detail black	RP-103	\$9.25 ^{EA}

ACCUMATCH™ INTERIOR DYES



This proprietary formula is approved by Ford and meets Ford OEM performance specifications. It penetrates and chemically bonds to any clean surface. Will not crack,

flake or peel. This does it all: Vinyl, Carpets, leather, hard plastic, exterior trim, convertible tops and metal. Really anything associated with a vehicle. Actually penetrates and chemically bonds, will not crack, flake or peel. Quick Drying formula, so parts can be touched and installed in as quick as 10 minutes. Will not fill in grain pattern. Truly an OEM finish in an aerosol can. Yes a little more money but well worth it. When painting the outside of your car, do you typically buy the cheapest paint you can find? LP-383 and PP-2322 are recommended for professional results.

Year	Description	Part No.	List
70-93	Light graphite	V-117	\$14.50 ^{EA}
70-93	Medium graphite	V-118	\$14.50 ^{EA}
67-73	Black/charcoal, metallic-iridescent	V-4464	\$14.50 ^{EA}
64-66	Black	V-946	\$14.50 ^{EA}
66-67	Dark red, metallic	V-5773	\$14.50 ^{EA}
69	Dark red, metallic	V-15641	\$14.50 ^{EA}

Year	Description	Part No.	List
68	Dark red, semi-gloss	V-5732	\$14.50 ^{EA}
68	Dark red, flat	V-5792	\$14.50 ^{EA}
69	Dark red	V-15847	\$14.50 ^{EA}
64-65	Bright red	V-6022	\$14.50 ^{EA}
71-73	Med vermillion, metallic	V-16050	\$14.50 ^{EA}
70	Vermillion	V-15945	\$14.50 ^{EA}
67-68	Dark blue, metallic	V-5770	\$14.50 ^{EA}
64-65	Med blue, metallic	V-5747	\$14.50 ^{EA}
71-73	Med blue, metallic	V-16049	\$14.50 ^{EA}
65	Light blue, metallic	V-5748	\$14.50 ^{EA}
66	Light turquoise, metallic	V-5752	\$14.50 ^{EA}
67-68	Dark aqua, metallic	V-5753	\$14.50 ^{EA}
70	Medium ivy green, metallic	V-15942	\$14.50 ^{EA}
73	Medium avocado	V-17023	\$14.50 ^{EA}
67	Dark gold, metallic	V-5734	\$14.50 ^{EA}
69	Dark ivy, metallic	V-15644	\$14.50 ^{EA}
69	Dark ivy	V-15854	\$14.50 ^{EA}
68-69	Medium ivy gold, metallic	V-5756	\$14.50 ^{EA}
64-66	Light ivy gold, metallic	V-5760	\$14.50 ^{EA}
67-68	Light ivy gold, metallic	V-5778	\$14.50 ^{EA}
70-73	Dark ginger	V-15940	\$14.50 ^{EA}
70-73	Medium ginger	V-15939	\$14.50 ^{EA}
67-68	Dark saddle	V-5738	\$14.50 ^{EA}
67-68	Saddle	V-5739	\$14.50 ^{EA}
65	Med palomino, metallic	V-5759	\$14.50 ^{EA}
64-65	Light palomino	V-17690	\$14.50 ^{EA}
68	Dark nugget gold, metallic	V-5798	\$14.50 ^{EA}
68-69	Light nugget gold, metallic	V-5800	\$14.50 ^{EA}
66	Medium emberglow, metallic	V-5777	\$14.50 ^{EA}
66	Parchment, metallic	V-5779	\$14.50 ^{EA}
67-68	Light parchment	V-4595	\$14.50 ^{EA}
64-66	White	V-5767	\$14.50 ^{EA}
69-73	White	V-15855	\$14.50 ^{EA}

Year	Description	Part No.	List
64-73	Clear coat, finisher	V-CC	\$12.95 ^{EA}

ACCUMATCH™ METAL DETAIL PAINT



Our detail paints give a natural looking finish to metal surfaces.

Year	Description	Part No.	List
64-73	Steel gray	RP-100	\$8.95 ^{EA}
64-73	Cast iron gray	RP-101	\$8.95 ^{EA}
64-73	Cast aluminum	RP-104	\$8.95 ^{EA}

ACCUMATCH™ SURFACE CLEANER



AccuMatch™ Surface Cleaner - for properly preparing vinyl and plastic surfaces before application of prep or dye products.

Year	Part No.	List
64-73	LP-383	\$10.95 ^{EA}

ACCUMATCH™ INTERIOR PREP



AccuMatch™ Interior Prep: A self-leveling, high-tech adhesion promoter, specifically formulated to fill nicks and scratches.

Year	Part No.	List
64-73	PP-2322	\$11.95 ^{EA}

ACCUMATCH™ HI-TEMP PAINT



This Hi-Temp Gray paint from AccuMatch™ is formulated specifically to withstand high engine compartment temperatures (up to 1200°). Leaves pieces with a natural cast-iron finish with less applications due to its extra-high pigment content. • Formulated to withstand extreme temperatures up to 1200°F • Perfect for headers & exhaust manifolds

Part No.	Year	Description	List
RP-102	64-73	Gray	\$9.95 ^{EA}

ACCUMATCH™ WHEEL PAINTS



AccuMatch™ Wheel Paints are specifically formulated to correctly match the most popular Mustang wheel colors, Classic Argent Gray and Charcoal Gray. • Gives a

smooth color-correct finish to wheel surfaces • Provides protection against corrosion and wear • Available in popular restoration colors

Part No.	Year	Description	List
L-17510	64-73	Classic argent gray	\$9.95 ^{EA}
L-17540	65-67	Styled steel charcoal gray	\$9.95 ^{EA}

ACCUMATCH™ SPECIAL APPLICATION PAINTS



AccuMatch™ Spray Paint (12 oz cans) OEM colors for specialty Mustang applications • 1970 Mach 1 Molding Dark Argent • 1964-65 Mustang Grille Gun Metal Blue •

1965-66 Power Steering Pump Blue. 1967-73 Power Steering Pump paint was a darker color. It will be available in early 2016 under part# RP-105.

Year	Description	Part No.	List
70	Mach 1 grille and rocker, dark argent	L-17500	\$10.95 ^{EA}
64-65	Mustang grille, gun metal blue	L-17530	\$10.95 ^{EA}
65-66	Power steering pump blue	L-17530	\$10.95 ^{EA}
67-73	Power steering pump blue	RP-105	\$10.95 ^{EA}

MARKAL PAINT STICK



Special paint sticks which were used by Ford at the assembly plants to mark fender aprons, radiator

support, transmission, rear end housing, sheet metal, glass and many other parts. These sticks are the attention to detail that wins shows.

Year	Description	Part No.	List
64-73	2 sticks, white and yellow	MPS-2	\$5.95 ^{PR}
64-73	12 pack	MPS-KIT	\$22.95 ^{KI}

ACCUMATCH™ FILLER PRIMER



AccuMatch™ Filler Primer, Gray (18 oz) • Highest solid content for filling surface blemishes • Quick drying primer provides extra hard sandable surfaces • Creates superior base for maximum top-coat adhesion

Year	Part No.	List
64-73	RP-204	\$9.95

ACCUMATCH™ PRO GRADE PRIMER



AccuMatch™ Pro-Grade Primers (12 oz) • Creates superior base for maximum top-coat adhesion • Seals surface for excellent durability

Part No.	Year	Description	List
RP-206	64-73	Gray	\$8.95 ^{EA}

ACCUMATCH™ SELF ETCHING PRIMER



AccuMatch™ Self Etching Primers. Acrylic resin formula gives excellent adhesion to aluminum, bare metal, and other prepared surfaces. **Large 18oz can.**

Year	Description	Part No.	List
64-73	Gray	RP-200	\$9.95 ^{EA}
64-73	Red oxide	RP-201	\$9.95 ^{EA}
64-73	Black	RP-202	\$9.95 ^{EA}
64-73	Gray - weld through	RP-203	\$9.95 ^{EA}

ACCUMATCH™ UNDERCOATING



AccuMatch™ automotive undercoatings are designed for complete undercarriage protection and sound-deadening. Available in either a standard asphalt-based formula, and also in our new rubberized formula for extra protection and sound-deadening properties. Undercoatings come in extra large 15oz cans for even the biggest jobs.

Year	Description	Part No.	List
64-73	Black, rubberized	RP-300	\$15.95 ^{EA}
64-73	Black, asphalt	RP-301	\$8.95 ^{EA}

WE PROUDLY FEATURE AUTHENTIC MUSTANG REPRODUCTIONS FROM SCOTT DRAKE!



SEALANTS & ADHESIVES

BEDDING AND GLAZING COMPOUND



This non-hardening, water resistant formula is designed for sealing windshields and rear windows on all cars using rubber gaskets. This bedding compound can be used between glass and metal, or between glass and rubber. Locks out dust and air, remains flexible and resilient, can be used for installing water shields. Supplied in 11 ounce tubes.

Year	Part No.	List
64-73	3M-8509	\$14. ⁹⁵ EA
64-73	CRL-7708	\$9. ⁹⁵ EA

HEADLINER GLUE



This high strength glue comes in an easy to use 4 ounce container with brush applicator built into lid.

Year	Part No.	List
64-73	HLG-1829	\$8. ⁵⁰ EA

INSIDE REARVIEW MIRROR ADHESIVE



Remounts rearview mirror bracket to windshield permanently. Mounting strength is 300 psi. Unaffected by hot and cold temperature variation. Supplied in 0.04 ounce tube.

Year	Part No.	List
64-73	PRO-61067	\$5. ⁹⁵ EA

SUPER TRIM ADHESIVE SPRAY



Very fast acting contact adhesive designed for two surface applications. Great for vinyl tops, headliners, insulation and padding. Supplied in a 19 ounce aerosol can. From 3M.

Year	Part No.	List
64-73	3M-8090	\$25. ⁹⁵ EA

WEATHERSTRIP ADHESIVE



Supplied in five ounce tubes. From 3M.

Year	Description	Part No.	List
64-73	Yellow, not for EPDM rubber	3M-8001	\$10. ⁹⁵ EA
64-73	Black, not for EPDM rubber	3M-8008	\$11. ⁹⁵ EA
64-73	Black, for EPDM rubber	3M-8011	\$11. ⁹⁵ EA

STRIP BODY CAULKING



Used to seal openings in the car body. Non-hardening, waterproof and will not shrink. Ideal for seams, cracks and joints. Especially useful when hanging fenders and mounting fuel tanks for proper sealing. Supplied in a box of 60 one-foot lengths. Black only.

Part No.	Year	List
3M-8578	64-73	\$24. ⁹⁵ EA

BODY SEAM SEALER STRIPS



Used to seal openings in the car body. Non-hardening, waterproof and will not shrink. Ideal for seams, cracks and joints. Especially useful when hanging fenders and mounting fuel tanks for proper sealing. Supplied in five 13 foot sections for a total of 65 ft. Correct dark gray for early Mustangs.

Part No.	Year	List
ESB-M4G32-A	64-73	\$24. ⁹⁵ EA

WINDSHIELD AND BODY SEALANT



This non-hardening, water resistant formula is designed for sealing windshields and rear windows on all cars using rubber gaskets. This bedding compound can be used between glass and metal, or between glass and rubber. Locks out dust and air, remains flexible and resilient, can be used for installing water shields. Supplied in 11 ounce tubes.

Year	Description	Part No.	List
64-73	Non-hardening	CRL-7708	\$9. ⁹⁵ EA

WINDSHIELD SEALANT



This formula cures into a tough, flexible, rubbery bead. Excellent adhesion to glass and all metals. Can be water tested in minutes. Works well for sealing drip rails in addition to glue in windshields.

Year	Part No.	List
64-73	CRL-7711	\$9. ⁹⁵ EA

TOOLS

IGNITION BEZEL TOOL



Don't scratch that new bezel or freshly painted dash with a screw driver. A dedicated tool made by Scott Drake.

Year	Part No.	List
67-68	T-100-YL	\$17. ⁹⁵ EA
69	T-109-CL	\$17. ⁹⁵ EA

WIPER BEZEL STEM NUT TOOL



Special tool designed to insert into wiper bezel stem nut used for assembly or disassembly. Will not damage nut.

Year	Part No.	List
64-66	T-110-RD	\$17. ⁹⁵ EA

EXTERNAL WIPER BEZEL NUT TOOL

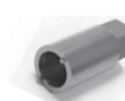

Specially designed for removing or installing bezel nuts, without risk of scratching or damaging bezel or paint.

Year	Part No.	List
64-65	T-120-BL	\$17. ⁹⁵ EA

BEZEL INSTALLATION TOOL



This dedicated tool is perfect for installing or removing the chrome bezel on our 1967 Mustang Convertible Top Switch, or the bezel on our 2010 Mustang Billet Antenna.

Year	Description	Part No.	List
67	1967 CV Top Switch Bezel & 2010 Antenna Bezel	T-67-BK	\$18. ⁹⁵ EA

FOG LIGHT SWITCH BEZEL TOOL



Another specialized tool used to install or remove the chrome bezel on the fog lamp switch. Helps prevent scratches from using improper tools.

Year	Part No.	List
65-67	T-65	\$17. ⁹⁵ EA

GLASS RUN TOP VENT SEAT TOOL



Time saving tool which removes old top vent window seals and installs new semi-tubular rivets with original looking results.

Year	Part No.	List
64-66	T-221	\$105 ⁹⁵ EA

TOP VENT RIVET TOOL



Finally the perfect tool for that tough little job. Includes 1 pair top seals and 4 rivets.

Year	Part No.	List
64-66	T-225	\$17 ⁹⁵ KI

DOOR HANDLE CLIP REMOVER



Removes special retaining clip on early door handles and window cranks. Stamped steel construction.

Year	Part No.	List
64-65	T-87600	\$7 ⁹⁵ EA

DOOR HINGE SPRING COMPRESSOR



This finger saver, makes installing the spring on the lower hinge quick and easy. For use only on a bench (off-car) rebuild and ALWAYS wear eye protection!

Year	Part No.	List
64-67	T-87675	\$21 ⁹⁵ EA

DOOR PANEL REMOVER



Stamped steel construction. Allows removal of door panels with out causing damage to panel or fasteners.

Year	Part No.	List
64-73	T-87650	\$11 ⁹⁵ EA

MOLDING REMOVER



Great for windshield and rear window moldings. Stamped steel with red coated handle.

Year	Part No.	List
64-73	T-87800	\$8 ⁹⁵ EA

CLEANERS & LUBRICANTS

RAGGTOP VINYL CLEANER



This is the best cleaner we have found. It is the only cleaner that has been tested & endorsed by HAARTZ, the world's largest manufacturer of convertible tops, and the Ford Motor Company. Safely removes the toughest stains. Over spray will not harm painted finishes. Retards grease, dirt and mildew. Anti-oxidant formula with low PH and no bleach. Leaves no residue. Biodegradable. Must use before applying RT-VP protectant. 16 oz. spray bottle.

Year	Part No.	List
64-73	RT-VC	\$10 ⁹⁵ EA

RAGGTOP VINYL PROTECTANT



This is the only protectant tested and endorsed by HAARTZ, the world's largest manufacturer of convertible tops. The protective film repels stains, acid rain, tree sap, bird droppings, salt, tar, grease and mildew. Contains Cibi Tinuvin 5151, the best ultra violet blocker available. Improves water and stain repellency. Will not streak. Does not contain silicone. 16 oz. spray bottle.

Year	Part No.	List
64-73	RT-VP	\$15 ⁵⁰ EA

RUST-BLOCK



Rust-Block is a new product that will coat the metal with a non-sticky coating that inhibits rust from forming up to 6-months. Just like Evapo-Rust, Rust-Block is safe on all metals, biodegradable and has no harmful fumes. Just spray on and when you're ready to paint or finish your metal item, just rinse off with warm soapy water or follow your normal paint prep procedures. Store your protected item indoors! This is a water-based product that will be rinsed off by rain/outdoor weather. Comes in a 16-oz. spray bottle. Made in the USA.

Year	Part No.	List
All	RB-015	\$9 ⁹⁵ EA

EVAPO-RUST



Evapo-Rust is the Rust Remover of the 21st Century. This Patent Pending formula will rapidly remove rust from all ferrous metals. This is

not a rust converter, it will actually remove all the rust leaving a clean metal surface. This formula is non-toxic, non-flammable, non-corrosive and biodegradable. No Fumes. Easy and Safe to use contains no solvents, acids, bases or hazardous ingredients. Will not pit or discolor un-rusted steel, also won't harm soft metals, plastic, rubber, PVC or Vinyl. This product is also re-useable but will lose performance over time. Simply Pre-clean item to remove any dirt or oil and then keep rusted part or area wet until all rust is removed. Most parts are rust free in 1-2 hours however deeply rust parts may require overnight soaking. Once part it rust free simple rinse off thoroughly with water and it is ready for Coating of your choice. If you will not be painting it quickly then allow EVAPO-RUST to dry on the part to give you up to 4 weeks protection from re-rusting (in a dry low humidity environment). When ready to paint simply rinse with water. For longer protection use our Rust Blocker that offers up to 6 months protection from-re-rusting. Made in the USA.

Year	Description	Part No.	List
All	1 Gallon Jug	ER-012	\$25 ⁹⁵ EA
All	5 Gallon Bucket	ER-013	\$104 ⁹⁵ EA

WE PROUDLY FEATURE AUTHENTIC MUSTANG REPRODUCTIONS FROM SCOTT DRAKE!



RUBBER PARTS

BASIC REPAINT KIT



This kit features some of the basics parts that are replaced during a basic repaint. Includes hood bumpers, door bumpers, trunk bumpers, tail lamp and lens gaskets, door handle pads, backup lamp pads, parking lamp pads, cowl to hood seal, antenna pad, trunk housing pad and quarter cap seals.

Year	Part No.	List
64-66	KIT-RUB-3	\$39 ⁹⁵ KI

BASIC REPAINT KIT



This kit features some of the basics parts that are replaced during a basic repaint. Includes hood bumpers, door bumpers, trunk lid bumpers, quarter panel extensions, front fender extension seals, round antenna gasket, door

handle pads, trunk lock gasket, tail light bezel gaskets, backup light pads, fuel filler pipe gasket and cowl to hood seal.

Year	Part No.	List
67-68	KIT-RUB-67-BODY	\$41 ⁹⁵ KI

FRONT & UNDER HOOD

FENDER EXTENSION SEAL



Small rubber extrusion which Year between headlight assembly and front fender edge. This

cures chipping paint problems. C9ZZ version is same extrusion just longer.

Year	Part No.	List
67-68	C7ZZ-13044	\$4 ⁰⁰ PR
67-70	C9ZZ-13044	\$4 ²⁵ PR

FENDER SPLASH SHIELD KIT



Scott Drake splash shield kits include the rubber seals and mounting hardware, for use with the customer's original splash

shield plates or our new standard splash shield plates.

Year	Part No.	List
64-66	CSZZ-16A572-A	\$13 ⁵⁰ KI
67-68	C7ZZ-16A572-A	\$15 ⁰⁰ KI

FENDER TO BODY PILLAR PAD

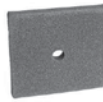

These pads fit near the cowl to prevent rattling or movement of the fenders against the body. Square, two required per car.

Year	Part No.	List
65-66	CSZZ-16246	\$1 ²⁵ EA

GENERATOR SPLASH SHIELD

Die cut sheet rubber. Our reproduction splash shield is an exact duplicate of the original rubber boot.

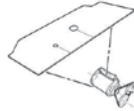

64: Outer
C40Z-10170-C

List
\$15⁹⁵ EA



64: Boot
C40Z-10170-D

List
\$29⁹⁵ EA

RADIATOR SUPPORT TO HOOD SEAL



Quality E.P.D.M. rubber extrusion. This kit also includes staples. Fits all 6 cylinder and most big blocks

Year	Part No.	List
64-70	C4DZ-16A238-A	\$6 ⁹⁵ KI

HOOD TURN SIGNAL LIGHT GASKET



Hood Turn Signal Lamp Gaskets. Sold in Pairs.

Year	Part No.	List
67-68	C7ZZ-13A368	\$1 ⁹⁵ PR

HOOD SCOOP SEAL



Fits behind hood scoop grill.

Part No.	Year	List
C9ZZ-16666	69-70	\$11 ⁹⁵ EA

RAM AIR HOOD SEAL



The thick rubber seal that fits between the air cleaner and the hood scoop.

Year	Description	Part No.	List
71-73	Proper thickness	D1ZZ-9624	\$98 ⁹⁵ EA

SHAKER AIR CLEANER SEAL



This rubber seal fits under the shaker intake to help seal around the hood opening.

Year	Description	Part No.	List
69-70	Original Ford	C9ZZ-9B624*	\$69 ⁹⁵ EA
69-70	Reproduction	C9ZZ-9B624-C	\$54 ⁹⁵ EA

AIR CLEANER LID GASKET



New sponge rubber seal which adheres to the inside top of the air cleaner lid.

Year	Description	Part No.	List
64-73	6 cyl.	C4DZ-9673	\$5 ⁹⁵ EA
65-67	289, 302	CSZZ-9673	\$5 ⁹⁵ EA
68-73	289, 302, 351 and '67 390	C8ZZ-9673	\$5 ⁹⁵ EA

FUEL LINE GROMMET

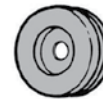

This is the grommet that protects the fuel line as it passes through the driver's side inner fender panel.

Year	Description	Part No.	List
64-67	5/16"	CSZZ-9288	\$1 ⁹⁵ EA
67-70	3/8"	C7ZZ-9288	\$1 ⁹⁵ EA
71-73	3/8", one-hole	D1ZZ-9288	\$1 ⁹⁵ EA
71-73	Two-hole	D1ZA-9K288-AA	\$5 ⁹⁵ EA

ACCELERATOR ROD GROMMET



This piece seals the accelerator rod where it passes through the firewall. Stops cold air and wind noise from entering the interior of the car.

Year	Part No.	List
64-66	C4AZ-9793-A	\$2 ⁷⁵ EA
67-68	C60Z-9793-A	\$2 ⁹⁵ EA

ACCELERATOR ROD GROMMET



All of our hood bumpers feature detail which others don't have. Produced from high quality rubber.

Year	Description	Part No.	List
64-68	Bulk	C4DZ-16758-B	\$0 ⁷⁵ EA
69-70	Bulk	C60Z-16758-A	\$0 ⁸⁵ EA
67-68	Bulk, rear	C7WV-16758-B	\$0 ⁷⁵ EA
71-73	Bulk	D1ZZ-16758-A	\$0 ⁸⁵ EA

SHOP WITH CONFIDENCE! WE OFFER SUPERIOR-QUALITY PARTS FOR ALL YOUR MUSTANG RESTORATION NEEDS.

HOOD BUMPER KIT



All of our hood bumpers feature detail which others don't have. Produced from high quality rubber. Packaged in a complete set of 4 bumpers.

Year	Description	Part No.	List
64-66	Set of 4	CSZZ-16758-K	\$3.25 ^{SE}
67-68	Set of 4	C7WY-16758-K	\$3.50 ^{SE}
69-70	Set of 4	C6OZ-16758-K	\$3.75 ^{SE}
71-73	Set of 4	D1ZZ-16758-K	\$3.75 ^{SE}

UNDER HOOD SEAL KIT



Features cowl to hood seal, hood bumpers and radiator support to hood bumpers.

Part No.	Year	List
KIT-RUB-2	64-66	\$15.95 ^{KI}

DELUXE HOOD BUMPER KIT



All of our hood bumpers feature detail which others don't have. Produced from high quality rubber. Packaged in a complete 6 piece set, for one car.

Year	Description	Part No.	List
65-66	Deluxe, 6 piece kit	CSZZ-16758-DLXK	\$8.95 ^{KI}
67-68	Deluxe, 6 piece kit	C7WY-16758-DLXK	\$9.95 ^{KI}
69-70	Deluxe, 6 piece kit	C6OZ-16758-DLXK	\$9.95 ^{KI}
71-73	Deluxe, 6 piece kit	D1ZZ-16758-DLXK	\$9.95 ^{KI}

FIREWALL TO HOOD BUMPERS



The Ford answer to anti-rattle on the hoods of the later Mustangs. Sold with attaching screws, and made to look exactly like the originals.

Year	Description	Part No.	List
69-70	Pair	380478-S2	\$3.50 ^{PR}
71-73	Set of 3	380478-S3	\$4.95 ^{SE}

FENDER COWL HOOD BUMPERS



Year	Description	Part No.	List
69-70	Pair	C9ZZ-16758	\$4.50 ^{PR}

RADIATOR SUPPORT TO HOOD BUMPER



Durable E.P.D.M. rubber with gold caminium plated shaft and nut.

Year	Part No.	List
64	CSZZ-16763-A	\$3.00 ^{EA}
65-73	CSZZ-16763-BULK	\$3.00 ^{EA}



65-73: Stainless steel, CNC machined
CSZZ-16763-S

List
\$24.95 ^{PR}

COWL TO HOOD SEAL



Our cowl to hood seals have been engineered to fit right. Each one features perfect detail, cross sections match originals.

Fasteners are installed, or have pre-punched retainer holes when needed.

Year	Part No.	List
64-66	CSZZ-16740-A	\$8.95 ^{EA}
67-68	C7ZZ-16740-A	\$8.95 ^{EA}
69-70	C9ZZ-16740	\$9.95 ^{EA}
71-73	D1ZZ-16740	\$10.00 ^{EA}

HOOD SEAL RETAINER CLIP



Stamped steel clips and mounting hardware included. Painted black. Kit includes 2 retaining clips and 4 mounting screws.

Year	Part No.	List
64-66	CSZZ-16A670-A	\$6.50 ^{KI}

ANTENNA BASE GROMMET



High quality compression molded neoprene rubber. Fits round base antennas.

Year	Part No.	List
64-67	CSZZ-18A813-A	\$1.00 ^{EA}

MARKER LIGHT LENS GASKET



These parts are precision die-cut for a great fit the first time.

Year	Description	Part No.	List
68	Front	C8ZZ-15A209	\$1.95 ^{PR}
69	Set of 4	C9AZ-15A447	\$2.50 ^{SE}
70	Rear	DOZZ-15A209	\$1.95 ^{PR}
71-73	Front	D1ZZ-15209	\$2.50 ^{PR}

MARKER TO BODY SEAL



These parts are precision die-cut for a great fit the first time.

Year	Description	Part No.	List
69	Set of 4	C9AZ-15A447	\$2.50 ^{SE}
70	Rear	DOZZ-15A447	\$2.50 ^{PR}
71-73	Rear	D1ZZ-15A447	\$2.50 ^{PR}

PARK LIGHT SEAL



Molded sponge, protects paint from chipping.

Year	Part No.	List
64-66	CSZZ-13217-A/B	\$4.50 ^{PR}

PARK LIGHT LENS GASKET



Gray foam gaskets to seal lens against housing.

Year	Description	Part No.	List
64-66		CSZZ-13211-A	\$1.50 ^{PR}
67-68		C7ZZ-13211-A	\$1.50 ^{PR}
70	Mach 1	C9WY-13211-A	\$2.95 ^{PR}
69-70		C9ZZ-13211-A	\$2.95 ^{PR}
71-72		D1ZZ-13211-A	\$2.95 ^{PR}

FRONT & UNDER HOOD

FRONT DOOR TO WINDOW SEAL



Made from a high quality rubber. These feature a steel insert molded inside. Fits on rear door edge. See Hardware category for screws.

Year	Description	Part No.	List
64-66		CSZZ-6520588/9B	\$9.95 ^{PR}
64-66	W/screws	CSZZ-6520588/9K	\$10.95 ^{PR}

WE PROUDLY FEATURE AUTHENTIC MUSTANG REPRODUCTIONS FROM SCOTT DRAKE!





67-68: Late
C7Z-6520588/9B

Year	Description	Part No.	List
			\$9.95 PR



67: Early
C7Z-6520588/9A

Year	Description	Part No.	List
			\$18.95 PR



69-70
C9Z-6520264/5A

Year	Description	Part No.	List
			\$9.95 PR



71-73
D1Z-6520264/5

Year	Description	Part No.	List
			\$19.95 PR

DOOR AND QUARTER SEAL SCREW



Used to secure the seals both on the quarter panel and on the rear of the door window seal. Black oxide finish.

Year	Description	Part No.	List
65-68	Set of 22	52718-S	\$2.95 KI
64-73	Bulk, sold in bags of 100	52718-SMK	\$15.00 EA

TOP VENT WINDOW SEAL



Made from compression molded E.P.D.M. rubber with cadmium plated steel inserts molded inside.

Includes rivets. Sold in sets.

Year	Description	Part No.	List
64-66		C5Z-6521774/5A	\$10.00 SE

VENT WINDOW DIVISION BAR SEAL

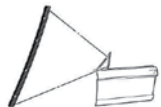

Offers a perfect fit with a steel insert molded into high quality E.P.D.M. rubber. Mounts on back side of vent window bar. Now original type rivets included.

Year	Description	Part No.	List
64-66		C5Z-6521450-A	\$8.00 EA

VENT WINDOW FRAME TO DOOR SEAL

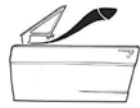

Seals between chrome vent frames and door on exterior side.

Year	Description	Part No.	List
67-68		C60Z-6322280	\$4.95 PR

VENT WINDOW SEAL



Our high quality Scott Drake reproduction vent seals offer your customers the finest molded rubber pieces available.

Year	Description	Part No.	List
64-66	RH and LH	C5Z-6521448/9B	\$34.95 PR
64-66	RH	C5Z-6521448-B	\$19.95 EA
64-66	LH	C5Z-6521449-B	\$19.95 EA
67-68	RH	C7Z-6521448-AR	\$23.95 EA
67-68	LH	C7Z-6521449-AR	\$23.95 EA

VENT WINDOW SEAL KIT



Convenient time saving kit offers you everything to complete vent seal installation. Kit features vents seals, top vent seals, back edge vent seals, and all rivets.

Check out our rivet tools to make the job easier.

Year	Description	Part No.	List
64-66		KIT-RUB-5	\$62.95 KI
67-68		KIT-RUB-6	\$64.95 KI

VENT WINDOW TO DOOR SEAL



These high quality vent window seals are the first on the market to replace the original Ford part exactly.

This is the small seal at the front of the door and next to the door weatherstrip.

Year	Description	Part No.	List
67-68		C7Z-6522332/3	\$13.95 PR

VENT SEAL EDGE RIVET



Correct black oxide semi-tubular rivet.

Year	Description	Part No.	List
64-66	Set of 10	351603-S	\$2.50 KI

WEATHERSTRIP FASTENER



Made exactly like the originals. Black plastic. Used many places throughout the car including Vent Window to Door Seal above.

Year	Description	Part No.	List
64-68	Set of 4	C1AB-6220807-A	\$2.00 SE

FRONT DOOR GLASS RUN CHANNEL



Vertical channel which runs behind vent window that door glass slides in. Features original type mohair inside channel,

mounting bracket and stainless steel trim. 69-70 Door Glass Runs are all steel construction.

Year	Description	Part No.	List
64-66	USA	C5Z-6521538/9A	\$105.95 PR
64-66	Import	C5Z-6521538/9I	\$94.95 PR
64-66	Import, RH	C5Z-6521538-A	\$50.95 EA
64-66	Import, LH	C5Z-6521539-A	\$50.95 EA
69-70	RH, steel	C9Z-6521546-A	\$34.95 EA
69-70	LH, steel	C9Z-6521547-A	\$34.95 EA

VENT WINDOW CHANNEL



Steel channel with door glass run insert installed.

Year	Description	Part No.	List
67-68	RH	C7Z-6521538-A	\$47.95 EA
67-68	LH	C7Z-6521539-A	\$47.95 EA

FRONT DOOR GLASS RUN INSERTS



Insert to replace worn rubber and felt channel guide for door glass. Features original looking felt. Top molded pieces

are bonded securely and has steel inserts for added strength.

Year	Description	Part No.	List
67-68		C7Z-6521546/7A	\$26.95 PR

CONCOURS WINDOW CHANNEL STRIPS



We proudly carry the full line of Re-Pops window channel strips. Rest assured that these are the highest quality on the market. These window channel strips have the correct bends and staples. They also come with easy to understand instructions and a drill bit for installation. Made in the USA.

Year	Description	Part No.	List
65-66	Fastback	C5ZZ-6321458/9S	\$64. ⁹⁵ SE
65-66	Coupe and convertible	C5ZZ-6521458/9S	\$80. ⁹⁵ SE
67-68	Fastback	C7ZZ-6321458/9S	\$56. ⁹⁵ SE
67-68	Coupe	C7ZZ-6521458/9S	\$72. ⁹⁵ SE
67-68	Convertible	C7ZZ-7621458/9S	\$72. ⁹⁵ SE
69-70	Fastback	C9ZZ-6321458/9S	\$63. ⁹⁵ SE
69-70	Coupe	C9ZZ-6521458/9S	\$89. ⁹⁵ SE
69-70	Convertible	C9ZZ-7621458/9S	\$89. ⁹⁵ SE
71-73	Fastback	D1ZZ-6321458/9S	\$86. ⁹⁵ SE
71-73	Coupe	D1ZZ-6521458/9S	\$86. ⁹⁵ SE
71-73	Convertible	D1ZZ-7621458/9S	\$86. ⁹⁵ SE

QUALITY IMPORT WINDOW CHANNEL STRIPS



These are a great alternative for those on a budget compared to our premium USA version. More like originals than our economy versions, listed below.

Year	Description	Part No.	List
65-66	Fastback	C5ZZ-6321458/9R	\$52. ⁹⁵ SE

ECONOMY WINDOW CHANNEL STRIPS



These feature narrow outer strips rather than concours wide outer strips. Good alternative for daily drivers.

Year	Description	Part No.	List
65-66	Fastback, economy	C5ZZ-6321458/9E	\$42. ⁹⁵ SE
64-66	Coupe & convertible, economy	C5ZZ-6521458/9E	\$62. ⁹⁵ SE

REAR VERTICAL GLASS RUN REPAIR KIT

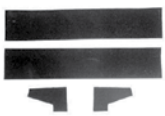

Original type style mohair/felt which covers run channel. Includes adhesive backing. Repairs both sides, Channel not included. See "Door" Section for complete Door Glass Assembly Runs.

Year	Part No.	List
64-66	C5ZZ-6521508-RK	\$22. ⁹⁵ KI

OUTSIDE DOOR HANDLE PAD



Fit between door handle and door body panel. Injection-molded plastic just like the original. Sold in complete sets only. 4 piece sets.

Year	Description	Part No.	List
64-70	Does not fit 67-68	C0DZ-6422428/9K	\$4. ⁰⁰ SE
67-68		C7ZZ-6522428/9K	\$4. ⁰⁰ SE

DOOR WEATHER STRIPPING

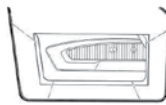

Made from the finest E.P.D.M. rubber, these sponge extrusions have transfer molded ends like the originals. These are not glued and feature the correct cross section and size for proper sealing. Includes original looking mounting fasteners.

Year	Description	Part No.	List
64-66	Door	C5ZZ-6520530/1A	\$19. ⁹⁵ PR
67-68	Door	C7ZZ-6520530/1A	\$24. ⁹⁵ PR
69-70	Door	C9ZZ-6520530/1A	\$39. ⁹⁵ PR
71-73	Door	D1ZZ-6520530/1A	\$59. ⁹⁵ PR

DOOR BOTTOM WEATHER STRIPPING



This seal cuts down wind and road noise. attaching hardware included.

Year	Description	Part No.	List
69-70	Door Bottom	C9ZZ-6520272-A	\$13. ⁹⁵ PR

DOOR GLASS TO QUARTER WINDOW SEAL



Made with long lasting E.P.D.M. rubber. Features the same detail as the originals. A steel insert is molded inside. See "Molding" section for stainless steel channels these slide into.

Year	Description	Part No.	List
69-70	Fastback, RH	D0ZZ-63214A14-R	\$14. ⁹⁵ EA
69-70	Fastback, LH	D0ZZ-63214A15-R	\$14. ⁹⁵ EA

69-70 FASTBACK QUARTER WINDOW SEAL



Year	Description	Part No.	List
69-70	Fastback	C9ZZ-6330222-S	\$21. ⁹⁵ PR

QUARTER WINDOW SEAL

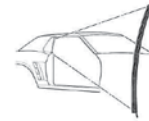

Made with long lasting E.P.D.M. rubber. Features the same detail as the originals. A steel insert is molded inside.

Year	Description	Part No.	List
64-68	Coupe, RH	C5ZZ-6530146-B	\$8. ⁰⁰ EA
64-68	Coupe, LH	C5ZZ-6530146-B	\$8. ⁰⁰ EA
64-68	Convertible, RH	C5ZZ-7630146-B	\$8. ⁰⁰ EA
64-68	Convertible, LH	C5ZZ-7630147-B	\$8. ⁰⁰ EA
69	Coupe and convertible, RH	C9ZZ-65214A14-A	\$14. ⁹⁵ EA
69	Coupe and convertible, LH	C9ZZ-65214A15-A	\$14. ⁹⁵ EA
71-73	Fastback, RH	D1ZZ-6330146-A	\$18. ⁹⁵ EA
71-73	Fastback, LH	D1ZZ-6330147-A	\$18. ⁹⁵ EA
71-73	Coupe and convertible, RH	D1ZZ-6530146-A	\$18. ⁹⁵ EA
71-73	Coupe and convertible, LH	D1ZZ-6530147-A	\$18. ⁹⁵ EA

QUARTER PANEL GRILLE GASKET



These gaskets are for the grille panels on the quarter panel. Sets of four each.

Year	Part No.	List
67	C7ZZ-65291C80-C	\$3. ⁹⁵ SE

DOOR GLASS TO QUARTER WINDOW SEAL



Made by Scott Drake, these Seals feature all the original details. Made of Quality rubber molded around a steel insert.

Year	Description	Part No.	List
64-66	Coupe and convertible	C5ZZ-6528182/3	\$9. ⁹⁵ PR
67-68	Coupe and convertible	C7ZZ-6528182/3	\$12. ⁵⁰ PR
69-70	Fastback	C9ZZ-6328182/3A	\$11. ⁹⁵ PR
69-70	Coupe and convertible	C9ZZ-6528182/3B	\$18. ⁰⁰ PR
71-73	Coupe and convertible	D1ZZ-6528182/3B	\$17. ⁵⁰ PR

WE PROUDLY FEATURE AUTHENTIC MUSTANG REPRODUCTIONS FROM SCOTT DRAKE!



DOOR AND QUARTER SEAL SCREW



Used to secure the seals both on the quarter panel and on the rear of the door window seal. Black oxide finish.

Year	Description	Part No.	List
65-68	Set of 22	52718-S	\$2.95 ^{KI}
64-73	Bulk, sold in bags of 100	52718-SMK	\$15.00 ^{EA}

WINDSHIELDS & ROOF

WINDSHIELD SEAL



Made from superior quality E.P.D.M. rubber, excellent detail, features spliced transfer molded corners like originals.

These offer quality we stand behind. No others compare.

Year	Part No.	List
64-68	C5Z-6503110-A	\$25.95 ^{EA}

REAR WINDOW SEAL

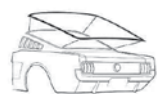

All of the below are made with superior quality E.P.D.M. rubber and feature transfer molded corners like the originals.

Year	Description	Part No.	List
65-66	Fastback	C5Z-6342084-A	\$26.95 ^{EA}
64-68	Coupe	C5Z-6542084-A	\$25.95 ^{EA}
67-68	Fastback	C7Z-6342084-A	\$26.95 ^{EA}
69-70	Fastback	C9Z-6342084	\$39.95 ^{EA}
69-70	Coupe	D0Z-6542084	\$39.95 ^{EA}
71-73	Fastback	D1Z-6342084-A	\$39.95 ^{EA}
71-73	Coupe	D1Z-6542084-A	\$39.95 ^{EA}

ROOF RAIL SEAL



These are the best on the market. We welcome comparison. Made from a quality neoprene extrusion with transfer molded ends,

not glued ends like some competitors. Includes fastening pins.

Year	Description	Part No.	List
65-66	Fastback	C5Z-6351222/3C	\$49.95 ^{PR}
64-66	Coupe	C5Z-6551222/3C	\$24.95 ^{PR}
67-68	Fastback	C7Z-6351222/3A	\$52.50 ^{PR}
67-68	Coupe	C7Z-6551222/3C	\$24.95 ^{PR}
69-70	Fastback	C9Z-6351222/3C	\$98.95 ^{PR}
69-70	Coupe	C9Z-6551222/3A	\$49.95 ^{PR}
71-73	CP/FB	D1Z-6551222/3A	\$64.95 ^{PR}

WINDOW SEALER



Used to water-proof windshield and rear window. Silicone type sealer is best suited for 69-73 glue in windshields.

Year	Description	Part No.	List
64-73	Non-hardening	CRL-7708	\$9.95 ^{EA}

MOLDING RETAINER CLIP

Exact OEM replacements. Plated to stop corrosion.



64-65
C5Z-65423A26-A

List

\$0.40^{EA}



66-73
C5Z-65423A26-B

List

\$0.35^{EA}



67-68: Coupe top rear molding only
C7Z-65423A26-A

List

\$0.90^{EA}



69-70: Windshield stops (screws included)
C8AZ-6203012-A

List

\$9.95^{PR}



69-70: Lower windshield molding
C9Z-6503406-A

List

\$3.25^{EA}

ROOF RAIL WEATHERSTRIP CLIP



Stamped steel with molded black vinyl, mounts on roofrail. Helps to hold weatherstrip and guides window glass. 4 required per car.

Year	Description	Part No.	List
69-70	Coupe and Fasback	C9Z-6522204	\$2.95 ^{EA}
71-73	For use at 1/4 window	D1Z-6522204	\$2.95 ^{EA}
71-73	For use at door	D1Z-6522244	\$3.95 ^{EA}

CONVERTIBLE PILLAR SEAL

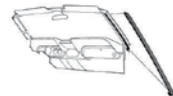

Superior quality E.P.D.M. sponge rubber with transfer molded ends.

Year	Description	Part No.	List
64-68	RH & LH	C5Z-7602626/7D	\$26.95 ^{PR}
69-70	RH	C9Z-7602626-A	\$129.95 ^{EA}
69-70	LH	C9Z-7602627-A	\$129.95 ^{EA}
71-73	RH & LH	D1Z-7602626/7A	\$84.95 ^{PR}

CV TOP HEADER TO WINDSHIELD SEAL



We offer this separately, for customers wanting to replace header only. Same quality as our complete kit.

Year	Part No.	List
64-68	C5Z-7653986-H	\$45.00 ^{EA}
71-73	D1Z-7651325-A	\$14.95 ^{EA}

CONVERTIBLE TOP SEAL KIT



The smart choice for the informed Mustang enthusiast. Our kit is the best, guaranteed! Don't be fooled by poor quality imitations. Comes with installation instructions. Note: Hardware not included. See kits 379361-SK & 351320-SK.

Year	Part No.	List
64-68	C5Z-7653986-K	\$99.95 ^{KI}
69-70	C9Z-7653986-K	\$164.95 ^{SE}
71-73	D1Z-7653986-K	\$229.95 ^{KI}

INTERIOR

SEAT ACCESS HOLE PLUG



Molded rubber. Ours feature the right details including stamped engineering numbers on top.

Year	Part No.	List
64-73	377901-S	\$0.75 ^{EA}

SHOP WITH CONFIDENCE! WE OFFER SUPERIOR-QUALITY PARTS FOR ALL YOUR MUSTANG RESTORATION NEEDS.

SHOCK ACCESS HOLE PLUG



Quality molded rubber. Features correct engineering numbers stamped on top.

Year	Part No.	List
64-70	378923-S	\$1.00 ^{EA}

RUBBER GROMMET KITS

A time saving and complete grommet and rubber plug set. May or may not be exact fit for Cougar.



64-66
C5ZZ-6511135-K

List
\$17.50 ^{KI}



67
C7ZZ-6511135-K

List
\$18.95 ^{KI}



68
C8ZZ-6511135-K

List
\$19.95 ^{KI}

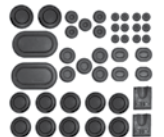

69-70
C9ZZ-6511135-K

List
\$24.95 ^{KI}



71-73
D1ZZ-6511135-K

List
\$15.95 ^{KI}

AUTOMATIC TRANS SHIFT HOUSING PLUG



Molded rubber plug, seals access hole in the side of shift housing. Not included in Rubber Grommet Kit.

Year	Part No.	List
65-73	C5ZZ-7C147-B	\$2.95 ^{EA}

SUN VISOR TIP



Soft rubber tips to go over the ends of the sun visor rods.

Year	Part No.	List
64-73	D1DZ-6204115-A	\$2.50 ^{PR}

INSTRUMENT LENS ANTI-RATTLE PAD



This kit takes away all the rattles caused from hardened and missing pads.

Year	Description	List
64-65	10 piece set	\$3.95 ^{SE}
66	13 piece set	\$4.95 ^{SE}

DOOR LIGHT GASKET



This pair of gaskets seal the door lamps to the door on Mustangs.

Year	Part No.	List
65-66	C5ZZ-13790	\$3.95 ^{PR}
67-68	C90Z-13790-A	\$2.95 ^{PR}

FASTBACK TRAP DOOR BUMPERS



Year	Part No.	List
67-70	370374-S	\$3.75 ^{PR}

FASTBACK SEAT LATCH BUMPER



This rubber bumper is used to keep the seat from rattling and also prevent damage when the seat is folded out for use.

Year	Part No.	List
65-66	C5ZZ-63613B30	\$4.95 ^{EA}
67-70	C7ZZ-63613B30/1	\$0.95 ^{PR}

FASTBACK SEAT BUMPERS

These parts are pressure molded in high density E.P.D.M. rubber and are an exact fit.



65-70: Set of 4
372260-S

List
\$3.95 ^{SE}



65: Early 65
372262-S

List
\$5.95 ^{PR}



65-70: Late 65
C6ZZ-6362426-A

List
\$9.95 ^{PR}

FIREWALL INSULATION FASTENERS



Year	Description	Part No.	List
64-73	Plastic replacement	357036-S100-P	\$3.50 ^{PR}
68-73	Rubber	C8ZZ-6501691	\$3.95 ^{PR}

GLOVE BOX DOOR BUMPERS



These are not off the shelf universal bumpers. These are the correct ones. Authentic in shape and detail.

Year	Part No.	List
64-66	375838-S	\$2.50 ^{PR}
67-70	380239-S	\$2.50 ^{PR}

ASH TRAY BUMPERS

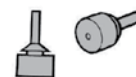

This is not a generic bumper. This one is built by Drake and is of the best quality and detail. An exact reproduction.

Year	Part No.	List
64-66	380369-S	\$1.50 ^{PR}

HEADLIGHT DIMMER SWITCH COVER PAD



Molded rubber cover which fits over headlamp dimmer switch.

Year	Part No.	List
65-73	C5ZZ-13533	\$4.95 ^{EA}

WE PROUDLY FEATURE AUTHENTIC MUSTANG REPRODUCTIONS FROM SCOTT DRAKE!



WASHER PUMP PEDAL PAD



Great reproduction of the original, with crisp detailing in the rubber.

Year	Part No.	List
67-68	C7ZZ-17664-P	\$2 ⁹⁵ EA

ACCELERATOR PEDAL



These steel reinforced parts are molded from high quality rubber for a long life and great appearance. See "Fuel" section for spring and retaining bolt.

Year	Description	Part No.	List
64-68	W/ stainless trim	C5ZZ-9735-D	\$9 ⁹⁵ EA
69-70	W/out trim	C9ZZ-9735-D	\$14 ⁹⁵ EA

BRAKE AND CLUTCH PEDAL PAD



Sold as a matching set for the clutch and brake pedals for manual transmission cars. High quality EPDM

rubber will look great for years. Great addition for those with a 302 or have done a 5.0 swap!

Year	Description	Part No.	List
65-68	5.0	C5ZZ-2457624-50	\$19 ⁹⁵ PR

BRAKE PEDAL PAD



Made by Scott Drake with exact detail of the original. Compression molded rubber. Disc brake versions include stainless steel center trim.

Year	Description	Part No.	List
64-67	W/power drum brakes	C5ZZ-2457-E	\$11 ⁹⁵ EA
64-67	Drum brakes. automatic trans	C5ZZ-2457-F	\$11 ⁹⁵ EA
65-73	Drum brakes. manual trans	C5ZZ-2457-G	\$11 ⁹⁵ EA
68-73	Drum brakes. automatic trans	C60Z-2457-A	\$11 ⁹⁵ EA

DISC BRAKE PEDAL PAD



Made by Scott Drake with exact detail of the original. Compression molded rubber. Disc brake versions include stainless steel center trim.

Year	Description	Part No.	List
65-67	Disc brakes. automatic trans	C5ZZ-2454-C	\$11 ⁹⁵ EA
64-67	Disc brakes. manual trans	C5ZZ-2454-D	\$11 ⁹⁵ EA
68-73	Disc brakes. automatic trans	D3ZZ-2454-G	\$11 ⁹⁵ EA

BRAKE PEDAL PAD TRIM



Replacement brake pedal pad trim.

Year	Description	Part No.	List
65-67	Auto trans	C5ZZ-2A487-B	\$8 ⁵⁰ EA
68-73	Auto trans	C60Z-2A487-A	\$10 ⁹⁵ EA
65-73	Man trans	D1ZZ-2A487-B	\$11 ⁹⁵ EA

PARKING BRAKE PEDAL PAD

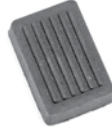

Made by Scott Drake, this Parking Brake Pad is an exact copy of the original. Molded from wear resistant rubber for years of use.

Year	Description	Part No.	List
69-73	Note: will NOT fit 1970 Mustang or Cougar	C9ZZ-2454-A	\$5 ⁹⁵ EA

PARKING BRAKE PEDAL PAD TRIM



Made from stainless steel, just like the originals.

Year	Description	Part No.	List
69-73	Note: will NOT fit 1970 Mustang or Cougar	C9ZZ-2A487-C	\$9 ⁹⁵ EA

CLUTCH PEDAL PAD



These reproduction pads are high quality replacements for worn or missing original pads.

Year	Part No.	List
65-68	C5ZZ-7A624-B	\$4 ⁹⁵ EA
69-73	C9ZZ-7A624-A	\$8 ⁹⁵ EA

CLUTCH PEDAL PAD TRIM



Replacement clutch pedal pad trim. Stainless steel construction.

Year	Part No.	List
65-68	C5ZZ-7B544-A	\$8 ⁹⁵ EA
69-73	C9ZZ-7B544-A	\$12 ⁹⁵ EA

TRUNK

TRUNK SEAL

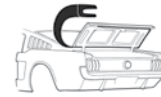

Perfect reproductions of the original. Made from long lasting E.P.D.M. sponge rubber.

Year	Description	Part No.	List
64-70	Coupe & convertible	COMB-6443720-C	\$9 ⁹⁵ EA
65-66	Fastback	C5ZZ-6343720-B	\$12 ⁵⁰ EA
67-68	Fastback	C7ZZ-6343720-B	\$14 ⁹⁵ EA
69-70	Fastback	C9ZZ-6343720-A	\$14 ⁹⁵ EA
71-73	All body styles	D2WY-6543720-A	\$17 ⁵⁰ EA
69-70	Shelby convertible	S9MS-7643720-A	\$24 ⁹⁵ EA

TRUNK WHEELHOUSE SEAM COVER



Rubber strip to clean up the sharp edge of the wheel housing seam. Important for protecting luggage and other easily damaged cargo. Originally used on left hand wheelhouse flange, but will fit RH side as well.

Year	Part No.	List
64-70	C5ZZ-6531466-A	\$2 ⁹⁵ EA

TENSION ROD ANTI-RATTLER



Designed to prevent vibration noise, these rubber sleeves slide over the trunk lid hinge tension rods.

Year	Part No.	List
64-68	C5ZZ-6545028	\$3 ⁹⁵ EA

QUARTER PANEL DRAIN PLUG

Durable E.P.D.M. rubber for the most weathered part of the car, the inside rear quarter panels. 1967 - 1968 features a steel insert, like the originals.



64-66
C40Z-62103A58-C

List
\$4⁰⁰ PR



67-68
C7ZZ-6511202-A

List
\$8⁰⁰ PR

SHOP WITH CONFIDENCE! WE OFFER SUPERIOR-QUALITY PARTS FOR ALL YOUR MUSTANG RESTORATION NEEDS.

QUARTER PANEL EXTENSION SEAL



Installs between quarter panels and extensions to prevent paint from cracking. Added after early production models

showed problems in the split line between the two parts.

Year	Part No.	List
64-66	C5ZZ-6527802-C	\$3.95 ^{PR}
67-68	C7ZZ-6527802-C	\$3.95 ^{PR}
69-73	C9ZZ-6527802-C	\$3.95 ^{PR}

REAR LICENSE PLATE DUST SHIELD



These rubber insulators prevent dust from accumulating on the surface

of the license plate by stopping the airflow between the bumper and the rear valance.

Year	Part No.	List
67-68	C7ZZ-6540427	\$3.95 ^{EA}
69-70	C9ZZ-6540427	\$3.95 ^{EA}

LICENSE PLATE BUMPER



These little bumpers remove big rattles. Year front or rear valances. 1964-68 front and 1964-70 rear.

Year	Part No.	List
64-70	375838-51	\$2.50 ^{PR}

SPOILER GASKET



Our gaskets are made of high quality EPDM rubber to provide years of service. Not just a flat piece of rubber.

These pads are formed to fit the slope of the trunk lid. Sold in matching pairs.

Year	Part No.	List
69-73	C9ZZ-6344228/9A	\$11.95 ^{PR}

TAIL LIGHT HOUSING GASKET



This gasket goes between the tail light housing and the body of the car on 1964 through 1966 Mustangs.

Year	Part No.	List
64-66	C5ZZ-13420-A	\$1.95 ^{PR}
67-68	C7ZZ-13420-A	\$1.95 ^{EA}
69	C9ZZ-13420-A	\$6.25 ^{PR}

TAIL LIGHT HOUSING TO BODY SEAL



Thick black molded mounting pads which protect and seal trunk from water and dirt.

Year	Part No.	List
67-68	C7ZZ-13520	\$17.50 ^{EA}
69	C9ZZ-13520	\$29.95 ^{EA}
70	D0ZZ-13520	\$24.95 ^{EA}
71-73	D1ZZ-13520	\$17.50 ^{EA}

TAIL LIGHT LENS GASKET

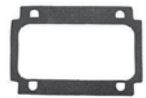

Precision die-cut gaskets for hassle-free installation. Made from the original type of material in each case.

Year	Description	Part No.	List
64-66		C5ZZ-13461-B	\$1.95 ^{PR}
67-68		C7ZZ-13461-A	\$3.95 ^{PR}
67	Cougar and Shelby	C7WY-13461	\$8.95 ^{PR}
68-70	Shelby and Cal Special	C4SZ-13461-A	\$8.95 ^{PR}
69		C9ZZ-13461-A	\$4.95 ^{PR}

TRUNK LID BUMPER



Feature perfect shape, detail, and resilience in the material. Injection molded in E.P.D.M. rubber specifically for the Mustang, not a universal type.

Year	Part No.	List
64-66	C5ZZ-6543634	\$2.95 ^{PR}
67-70	C7ZZ-6543634	\$2.95 ^{PR}

TRUNK LOCK CYLINDER HOUSING PAD

Precision molded pad to place behind the cylinder sleeve flange. Seals between the cylinder and trunk surface.



C5ZZ-6543625-B
64-66

List

\$1.95^{EA}



C7AZ-6543625-A
67-73: Trunk and door locks

List

\$1.95^{EA}

LICENSE PLATE LIGHT LENS GASKET



Precision die-cut gaskets from the original material used on the Mustang.

Year	Part No.	List
65-73	C7AZ-13568-A	\$0.95 ^{EA}

BACK UP LIGHT LENS GASKET

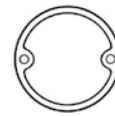

Molded sponge, good fit. Seals lens to housing.

Year	Part No.	List
65-70	C5ZZ-15510-A	\$1.50 ^{PR}

BACK UP LIGHT PAD



Molded Black rubber, good fit. Seals housing to rear valance panel.

Year	Description	Part No.	List
64-66	Black	C5ZZ-15533-A/B	\$3.95 ^{PR}
67-70	Gray	C7ZZ-15533-A	\$3.95 ^{PR}

SHEET METAL

HOOD, FRONT, VALANCE & FENDER

REPRODUCTION HOOD



Our reproduction hoods are formed and assembled overseas for an inexpensive alternative to O.E.M. parts. Shipped primed black for corrosion protection.

Part No.	Year	Description	List
C5ZZ-16612-BR	65-66	New tooling! Very good fit	\$164.95 ^{EA}
C7ZZ-16612-CR	67-68	W/out turn signal reliefs	\$189.95 ^{EA}
C7ZZ-16612-DR	67-68	W/ turn signal reliefs	\$189.95 ^{EA}
C9ZZ-16612-AR	69-70	Underside correct for 69	\$299.95 ^{EA}
C9ZZ-16612-SHRK	69-70	W/ Shaker hole cut	\$399.95 ^{EA}
D0ZZ-16612-TL	70	W/ Twist Lock holes cut	\$399.95 ^{EA}
D0ZZ-16612-M/SH	70	W/ Lock & Shaker holes	\$409.95 ^{EA}
D1ZZ-16612-AR	71-73	W/ 2 scoop cut outs	\$349.95 ^{EA}

Sheet Metal

WE PROUDLY FEATURE AUTHENTIC MUSTANG REPRODUCTIONS FROM SCOTT DRAKE!



195

FORD OEM TOOLING HOOD

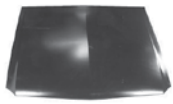

Superior quality replacement sheetmetal hood produced from Ford's original tooling and in most cases by Ford's

original manufacturer. These parts come with an electrostatically applied epoxy base primer for superior adhesion and rust protection. **Call for availability, prices subject to change.**

Year	Description	Part No.	List
64	W/ sharp edges	C4ZZ-16612-B	Call
65-66		C5ZZ-16612-B	Call
67-68	W/out turn signal reliefs	C7ZZ-16612-C	Call
67-68	W/turn signal reliefs	C7ZZ-16612-D	Call
69-70	Underside correct for 1970	D0ZZ-16612-A	Call

RTM - FIBERGLASS SHELBY HOOD



These Fiberglass Hoods are manufactured using the RTM method (Resin Transfer Mold), which produces a consistent part in both fit and appearance unlike chopped or hand-laid fiberglass hoods that vary from part to part. Also, although not concours in appearance for original Shelby's, the RTM process gives a clean factory appearance underneath, rather than a typical aftermarket fiberglass hood. It will still require additional prep work compared to sheet metal hoods.

Year	Description	Part No.	List
64-66	With metal frame	S1MS-16612-MF	\$474. ⁹⁵ EA

HOOD SCOOP

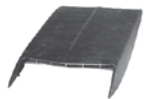

C9ZZ-16C630-A
69-70: Mach/GT, Bolt on

List
\$124.⁹⁵ EA

D1ZZ-16C630/1
71-73

List
\$84.⁹⁵ PR

S1MS-16025
65-66: Shelby, bond on fiberglass

List
\$54.⁹⁵ EA



S1MS-16025-B
65-66: Shelby Bolt-on fiberglass

List
\$101.⁹⁵ EA



S1MS-16025-M
65-66: Shelby, stamped steel - Available late 2015

List
\$124.⁹⁵ EA



S7MS-16025-E
67-68: Eleanor, bond on

List
\$104.⁹⁵ EA

HOOD SCOOP GRILLE

Grille that fits across the front of the hood scoop to keep out birds and low flying aircraft



C9ZZ-16A624-BLT
69-70: Mach 1, Billet

List
\$74.⁹⁵ EA



C9ZZ-16A624-C
69-70: Mach 1

List
\$49.⁹⁵ EA



D1ZZ-16A624/5-A
71-73

List
\$29.⁹⁵ PR

HOOD TURN SIGNAL INSERT



Now made by Scott Drake. Quality die cast with exact fit and detail. We made the grill support straps stronger

to prevent breakage to this commonly broken area. Includes grill and studs. Ready to paint.

Part No.	Year	Description	List
C7ZZ-16720-A	67-68	RH	\$59. ⁹⁵ EA
C7ZZ-16721-A	67-68	LH	\$59. ⁹⁵ EA

HOOD TURN SIGNAL INSERT GRILLE



Now made by Scott Drake. Exact detail. Ready to paint

Part No.	Year	Description	List
C7ZZ-16870-A	67-68		\$23. ⁹⁵ EA

SHAKER HOOD TRIM RING



Pressure die cast construction. Hides raw edge of hood. Includes two mounting brackets. See "Engine" section for actual shaker assembly.

Part No.	Year	List
C9ZZ-16958-A	69-70	\$144. ⁹⁵ EA

SHAKER HOOD TRIM RING BRACKETS



New by Drake, these 1969-70 Shaker Hood Trim Ring Retaining Brackets are made of steel with a matte black finish.

Scott Drake has made an exact reproduction of a hard to find part. Sold in pairs.

Part No.	Year	List
C9ZZ-16995-A	69-70	\$24. ⁹⁵ PR

HOOD HINGE



Heavy duty steel stampings. Painted black. Not cheap, flimsy versions that are available from others.

Part No.	Year	Description	List
C30Z-16796-AR	64-66	RH, Concours	\$37. ⁹⁵ EA
C30Z-16797-AR	64-66	LH, Concours	\$37. ⁹⁵ EA
C30Z-16796-R	64-66	RH, Economy	\$31. ⁹⁵ EA
C30Z-16797-R	64-66	LH, Economy	\$31. ⁹⁵ EA
C7ZZ-16796-AR	67-70	RH	\$35. ⁹⁵ EA
C7ZZ-16797-AR	67-70	LH	\$35. ⁹⁵ EA

HOOD HINGE MOUNTING KIT



Part No.	Year	List
359662-SMK	64-70	\$6. ⁵⁰ KI

HOOD HINGE SPRING



Standard equipment springs for that finishing touch on the hinges. Not for Shelby cars with fiberglass hoods.

Year	Description	Part No.	List
64-70	Concours USA	C30Z-16789-A	\$14. ⁹⁵ EA
64-70	Imported	C30Z-16789-AR	\$5. ⁹⁵ EA
65-68	For Shelby Fiberglass	S7MS-16785	\$34. ⁹⁵ PR

HOOD LATCH

Complete latch now available. With or without top plate. Painted black.



64-65: w/ top plate
C5ZZ-16700

List
\$79.⁹⁵ EA



65: w/ support brace
C5ZZ-16700-K

List
\$104.⁹⁵ EA



66: w/ support plate
C6ZZ-16700

List
\$104.⁹⁵ EA



66: w/ out support plate
C6ZZ-16700-B

List
\$69.⁹⁵ EA



67-68:
C7ZZ-16700-C

List
\$64.⁹⁵ EA



67-68
C7ZZ-16700-A

List
\$45.⁹⁵ EA



69-70
C9ZZ-16700-A

List
\$69.⁹⁵ EA



69-70
C9ZZ-16700-R

List
\$44.⁹⁵ EA



71-73
D1ZZ-16700

List
\$61.⁹⁵ EA

HOOD LATCH PIN



In our constant pursuit of perfection we now offer a 100% concurs correct 64-66 hood latch pin with the correct original yellow zinc finish and concurs

phosphate washer and nut to meet all of your judging needs. For daily drivers we still offer our attractive and very affordable C5ZZ-16929-A hood latch pin or our stainless steel version C5ZZ-16929-S.

Year	Description	Part No.	List
64-66	Concours	C5ZZ-16929-SHOW	\$14. ⁹⁵ EA
64-66	Zinc	C5ZZ-16929-A	\$9. ⁹⁵ EA
64-66	Stainless	C5ZZ-16929-S	\$16. ⁹⁵ EA

HOOD SAFETY LATCH



Made by Scott Drake our Stainless Steel Hood Safety is polished stainless steel for a great look and long

life! Optional polished, stainless steel mounting bolts available under part # 378178-SS. Also available in a black finish.

Year	Description	Part No.	List
64-66	Stainless Steel	C4DZ-16918-S	\$15. ⁹⁵ EA
64-66	Black	C4DZ-16918-B	\$9. ⁹⁵ EA

HOOD SAFETY LATCH



Made by Scott Drake this Stainless Steel Hood Latch Striker replaces the old, original steel

striker. Made from polished stainless steel for a great look and long life! Optional polished, stainless steel mounting bolts available under part # 378178-SS.

Year	Part No.	List
67-68	C7ZZ-16929-S	\$14. ⁹⁵ EA

HOOD PROP ROD



This prop rod is made from high quality 304 stainless steel rod and polished to really catch the eye. Stainless steel

washers and spring also included. Total rod length is 35 inches but can be cut to length if desired.

Year	Description	Part No.	List
64-68	Stainless	C5ZZ-16826-S	\$34. ⁹⁵ SE
65	Shelby	S1MS-16826	\$28. ⁹⁵ EA

HOOD LATCH SUPPORT BRACE



This brace is used to reinforce the hood latch where it fastens to the core support on 1965 and 1966 Mustangs.

Year	Part No.	List
64-66	C5ZZ-16747-A	\$12. ⁹⁵ EA

FRONT VALANCE



Our stamping's are all carefully tooled to eliminate fit-up problems during installation. We offer the best fitting valances in the business for satisfied customers each time.

Year	Description	Part No.	List
64-66	OEM Tooling	C5ZZ-17A939-A	\$124. ⁹⁵ EA
64-66	New improved tooling	C5ZZ-17A939-AC	\$49. ⁹⁵ EA
64-66	Reproduction	C5ZZ-17A939-AR	\$45. ⁹⁵ EA
67-68	OEM Tooling	C7ZZ-17A939-A	\$124. ⁹⁵ EA
67-68	New improved tooling	C7ZZ-17A939-AC	\$49. ⁹⁵ EA
67-68	Reproduction	C7ZZ-17A939-AR	\$45. ⁹⁵ EA
69		C9ZZ-17A939-AR	\$79. ⁹⁵ EA
70		D0ZZ-17A939-AR	\$79. ⁹⁵ EA
71-72		D1ZZ-17A939-AR	\$109. ⁹⁵ EA
73		D3ZZ-17A939-AR	\$114. ⁹⁵ EA

FIBERGLASS FRONT VALANCE



Manufactured using RTM method providing a better fit and finish than typical fiberglass parts.



Year	Description	Part No.	List
64-66	R model, use w/ front bumper	S1MS-17A939-RB	\$149. ⁹⁵ EA
67-68	R model, use w/ front bumper	S7MS-17A939-R	\$149. ⁹⁵ EA

Sheet Metal

WE PROUDLY FEATURE AUTHENTIC MUSTANG REPRODUCTIONS FROM SCOTT DRAKE!



FRONT SPOILER



Vacuumed formed impact resistant plastic with textured surface.

Year	Part No.	List
64-66	C5ZZ-63001A74-A	\$109. ⁹⁵ EA
67-68	C7ZZ-63001A74-A	\$109. ⁹⁵ EA
69	C9ZZ-63001A74-A	\$84. ⁹⁵ EA
70	D0ZZ-63001A74-A	\$84. ⁹⁵ EA
71-73	D1ZZ-63001A74-A	\$84. ⁹⁵ EA

STONE DEFLECTOR



Mounts behind the front bumper.

Stamped steel, shipped lacquered black for protection.



Year	Description	Part No.	List
64-66	From OEM tooling	C5ZZ-17779-A	\$134. ⁹⁵ EA
64-66	Economy, import	C5ZZ-17779-AR	\$29. ⁹⁵ EA
64-66	From new improved tooling	C5ZZ-17779-B	\$59. ⁹⁵ EA
67-68	From OEM tooling	C7ZZ-17779-A	\$129. ⁹⁵ EA
67-68	From new improved tooling	C7ZZ-17779-AR	\$29. ⁹⁵ EA
69		C9ZZ-17779-AR	\$31. ⁹⁵ EA
70		D0ZZ-17779-AR	\$29. ⁹⁵ EA

STONE DEFLECTOR BRACKET



Three piece metal stone guard bracket set. Flat black coated like originals.

Year	Part No.	List
67-68	C7ZZ-17747-AR	\$34. ⁹⁵ SE

VALANCE TO FRAME BRACKET



Brackets to attach the front valance to the inner bumper brace.



Year	Part No.	List
69-70	C9ZZ-17747-A	\$10. ⁹⁵ PR

GRILLE SUPPORT BRACKET



Year	Description	Part No.	List
64-66	Black, concurs, OE thickness	C5ZZ-8390-F	\$62. ⁵⁰ EA
64-66	Economy	C5ZZ-8390-FR	\$64. ⁹⁵ EA

GRILLE SUPPORT BRACKET



Year	Description	Part No.	List
69	Black	C9ZZ-8182-A	\$32. ⁹⁵ EA
70	Raw steel	D0ZZ-8232-A	\$42. ⁹⁵ EA

NOSE REINFORCEMENT



Used on Shelby cars. Stamped metal to give fiberglass extra support.

Year	Part No.	List
68	S8MS-8B231-A	\$18. ⁹⁵ EA

NOSE BRACKET



Used on Shelby cars. Stamped steel construction, like original. Painted black.

Year	Description	Part No.	List
68	RH, Shelby	S8MS-17792-A	\$18. ⁹⁵ EA
68	LH, Shelby	S8MS-17793-A	\$18. ⁹⁵ EA

FRONT LICENSE BRACKET



Bracket used to mount a front license plate to the valance.

Year	Description	Part No.	List
69-70		C9ZZ-17A385-B	\$14. ⁹⁵ EA
71-73	Chrome bumper	D1ZZ-17A385-A	\$19. ⁹⁵ EA
71-73	Urethane bumper	D1ZZ-6540522-A	\$26. ⁹⁵ EA

REPRODUCTION FENDER



Our reproduction fenders offer an inexpensive alternative to purchasing O.E.M. parts, with only a slight loss in fit when compared with genuine Ford parts. Shipped painted black and deburred.

Year	Description	Part No.	List
64-66	RH	C5ZZ-16005-AR	\$159. ⁹⁵ EA
64-66	LH	C5ZZ-16006-AR	\$159. ⁹⁵ EA
67	RH	C7ZZ-16005-AR	\$169. ⁹⁵ EA
67	LH	C7ZZ-16006-AR	\$169. ⁹⁵ EA
68	RH	C8ZZ-16005-AR	\$169. ⁹⁵ EA
68	LH	C8ZZ-16006-AR	\$169. ⁹⁵ EA
69	RH	C9ZZ-16005-AR	\$244. ⁹⁵ EA
69	LH	C9ZZ-16006-AR	\$244. ⁹⁵ EA
70	RH	D0ZZ-16005-AR	\$239. ⁹⁵ EA
70	LH	D0ZZ-16006-AR	\$239. ⁹⁵ EA
71-72	RH	D1ZZ-16005-AR	\$289. ⁹⁵ EA
71-72	LH	D1ZZ-16006-AR	\$289. ⁹⁵ EA
73	RH	D3ZZ-16005-AR	\$289. ⁹⁵ EA
73	LH	D3ZZ-16006-AR	\$289. ⁹⁵ EA

LOWER REAR CORNER OF FENDER



Comes with rear edge to form door opening.

Year	Description	Part No.	List
64-66	LH	M104LH	\$39. ⁹⁵ EA
64-66	RH	M104RH	\$39. ⁹⁵ EA
67-68	LH	M204LH	\$39. ⁹⁵ EA
67-68	RH	M204RH	\$39. ⁹⁵ EA

INNER STRUCTURE OF FENDER



Inner structure behind the lower rear corner of the fender. Very common to rust.

Year	Description	Part No.	List
64-66	LH	M104ALH	\$23.95 ^{EA}
64-66	RH	M104ARH	\$23.95 ^{EA}
67-68	LH	M204ALH	\$23.95 ^{EA}
67-68	RH	M204ARH	\$23.95 ^{EA}

HEADLIGHT BUCKET ASSEMBLY



Reproduction headlight bucket assembly. Kit contains mounting hardware. See Website for individual photos of each kit.

Part No.	Year	Description	List
CSZZ-13008-CR	65-66	RH	\$144.95 ^{KI}
CSZZ-13008-DR	65-66	LH	\$144.95 ^{KI}
C7ZZ-13008-CR	67-68	RH	\$164.95 ^{EA}
C7ZZ-13008-DR	67-68	LH	\$164.95 ^{EA}
C9ZZ-16018-R	69	RH	\$329.95 ^{EA}
C9ZZ-16019-L	69	LH	\$329.95 ^{EA}
DOZZ-16018-R	70	RH	\$439.95 ^{EA}
DOZZ-16019-L	70	LH	\$439.95 ^{EA}

HEADLIGHT BUCKET HOUSING



Year	Description	Part No.	List
65-66	LH	C5ZZ-13100-L	\$89.95 ^{EA}
65-66	RH	C5ZZ-13100-R	\$89.95 ^{EA}
70	RH	DOZZ-16018	\$239.95 ^{EA}
70	LH	DOZZ-16019	\$239.95 ^{EA}

HEADLIGHT DOOR

Die cast headlight door which Year on the headlight assembly. Primered.



C5ZZ-13064-B1965-66
C5ZZ-13064-B (RH)
C5ZZ-13064-A (LH)

List
\$32.95^{EA}



67-68 : Primered
C7ZZ-13064-A

List
\$19.95^{EA}



67-68: Chrome (set of 2, includes 6 chrome screws)
C7ZZ-13064-C

List

\$45.95ST



69: Outer, chrome
C9ZZ-13064-A

List

\$29.95^{EA}



69: Inner
C9ZZ-13064-B/C

List

\$49.95^{PR}



70
DOZZ-13064-A/B

List

\$49.95^{PR}

HEADLIGHT EXTENSION PLATE



Part No.	Year	Description	List
DOZZ-16G556-A	70	RH	\$26.95 ^{EA}
DOZZ-16G557-A	70	LH	\$26.95 ^{EA}

PARKING LIGHT RETAINER



Stamped steel and zinc plated to prevent rust. Year behind parking lamps.

Year	Description	Part No.	List
64-66	RH	C5ZZ-13220-C	\$4.95 ^{EA}
64-66	LH	C5ZZ-13221-C	\$4.95 ^{EA}
67-68	RH	C7ZZ-13220-A	\$15.95 ^{EA}
67-68	LH	C7ZZ-13221-A	\$15.95 ^{EA}

FRONT FENDER MOLDING



New 1971-72 Paint to Match version (pictured) is made from Original Ford Tooling!

Year	Description	Part No.	List
71-72	Chrome	D1ZZ-16160/1	\$92.50 ^{PR}
71-72	Paint to match	D1ZZ-16160-B	\$84.50 ^{PR}
73	Paint to match	D3ZZ-16160/1	\$94.95 ^{PR}

FENDER TO BUMPER FILLERS



For 71-72 Mustangs with chrome front bumper. This is molded soft plastic that fills the gap between

the bumper and fender. Exact reproduction and exact colors as the originals. Includes attaching screws.

Year	Part No.	List
71-72	D1ZZ-16554	\$54.95 ^{PR}

DELUXE SPLASH SHIELD



All new stampings which include fresh rubber, securely attached. A real time saver.

Year	Description	Part No.	List
64-66	Front, right	C5ZZ-16102-AR	\$18.95 ^{EA}
64-66	Rear, right	C5ZZ-16102-BR	\$19.95 ^{EA}
64-66	Front, left	C5ZZ-16103-AR	\$18.95 ^{EA}
64-66	Rear, left	C5ZZ-16103-BR	\$19.95 ^{EA}
67-68	Front, right	C7ZZ-16102-AR	\$19.95 ^{EA}
67-68	Rear, right	C7ZZ-16102-BR	\$20.95 ^{EA}
67-68	Front, left	C7ZZ-16103-AR	\$19.95 ^{EA}
67-68	Rear, left	C7ZZ-16103-BR	\$20.95 ^{EA}

STANDARD SPLASH SHIELD



New stampings which need to have our rubber splash shield kit attached prior to use. See the "Rubber & Weatherstripping" category earlier in this catalog.

Year	Description	Part No.	List
65-66	Front, right	C5ZZ-16102-A	\$10.95 ^{EA}
65-66	Rear, right	C5ZZ-16102-B	\$12.95 ^{EA}
64-66	Front, left	C5ZZ-16103-A	\$10.95 ^{EA}
64-66	Rear, left	C5ZZ-16103-B	\$12.95 ^{EA}
67-68	Front, right	C7ZZ-16102-A	\$10.95 ^{EA}
67-68	Rear, right	C7ZZ-16102-B	\$12.95 ^{EA}
67-68	Front, left	C7ZZ-16103-A	\$10.95 ^{EA}
67-68	Rear, left	C7ZZ-16103-B	\$12.95 ^{EA}

REAR SPLASH SHIELD SUPPORT BRACKET



Year	Part No.	List
67-68	C7ZZ-16256/7-A	\$9.95 ^{PR}

WE PROUDLY FEATURE AUTHENTIC MUSTANG REPRODUCTIONS FROM SCOTT DRAKE!



SPLASH SHIELDS



Now available from Scott Drake are these Mustang Fender Splash Shields. These are the plastic shields that screw onto the inside of

the Front Fender and onto the cowl in the rear of the Fender to protect water, mud and debris from building up and potentially cause corrosion problems.

Year	Part No.	List
69	C9ZZ-16102/3-K	\$104. ⁹⁵ EA
70	D0ZZ-16102/3-K	\$89. ⁹⁵ EA

ENGINE COMPARTMENT

RADIATOR SUPPORT

Heavy gauge steel stampings for serious front sheet metal repairs. Shipped lacquered black for corrosion protection. Available with or without lower crossmember attached.



Year	Description	Part No.	List
64-66	w/out crossmember	C5ZZ-16138-A	\$74. ⁹⁵ EA
64-66	w/ crossmember attached	C5ZZ-16138-WCM	\$124. ⁹⁵ EA
67-68	w/out crossmember	C7ZZ-16138-B	\$94. ⁹⁵ EA
67-68	w/ crossmember attached	C7ZZ-16138-WCM	\$144. ⁹⁵ EA
69		C9ZZ-16138-A	\$124. ⁹⁵ EA
69	w/crossmember	C9ZZ-16138-WCM	\$134. ⁹⁵ EA
70		D0ZZ-16138-A	\$124. ⁹⁵ EA
70	w/crossmember	D0ZZ-16138-WCM	\$134. ⁹⁵ EA
71-73		D1ZZ-16138-A	\$177. ⁹⁵ EA

FRONT CROSS MEMBER



Stamped steel construction. Many get damaged due to improper jack lifting or front end collisions.

Year	Description	Part No.	List
64-66		MM133	\$49. ⁹⁵ EA
67-70	Economy, w/out holes drilled & nut	MM233	\$52. ⁹⁵ EA
67-70	W/ holes drilled & center nut	MM233-WH	\$69. ⁹⁵ EA

STRUT ROD BRACKET



High quality steel, painted black.

Year	Description	Part No.	List
64-66	LH	C5ZZ-6503487-L	\$44. ⁹⁵ EA
64-66	RH	C5ZZ-6503487-R	\$44. ⁹⁵ EA
67-70	LH	C7ZZ-6503487-L	\$49. ⁹⁵ EA
67-70	RH	C7ZZ-6503487-R	\$49. ⁹⁵ EA

INNER FRONT FENDER BRACKET



Connects the fender to the front fender apron.

Year	Description	Part No.	List
64-66	LH	M123LH	\$28. ⁹⁵ EA
64-66	RH	M123RH	\$28. ⁹⁵ EA

BATTERY FENDER APRON (RH)



Good seller, many need replacing due to front end collisions, rust, & battery acid damage.

Year	Description	Part No.	List
64-66	RH, Quality Import w/ bracket	C5ZZ-16054-A	\$45. ⁹⁵ EA
64-66	RH, Economy Import	M116RH	\$39. ⁹⁵ EA
67-68	RH, USA	M216RH	\$41. ⁹⁵ EA
67-68	RH, Quality Import	C7ZZ-16054-A	\$40. ⁹⁵ EA
67-68	RH, Economy Import	M216RH-T	\$29. ⁹⁵ EA
69-70	RH, Quality Import	C9ZZ-16054-AR	\$42. ⁹⁵ EA
71-73	RH, Import	M416RH	\$42. ⁹⁵ EA

FRONT FENDER APRON (LH)



Good seller, many need replacing due to front end collisions and rust.

Year	Description	Part No.	List
64-66	LH, Quality Import w/ bracket	C5ZZ-16055-A	\$45. ⁹⁵ EA
64-66	LH, Economy Import	M116LH	\$39. ⁹⁵ EA
67-68	LH, Economy Import	M216LH	\$36. ⁹⁵ EA
67-68	LH, Quality Import	C7ZZ-16055-A	\$41. ⁹⁵ EA
69-70	LH, Quality Import	C9ZZ-16055-AR	\$41. ⁹⁵ EA
71-73	LH, Import	M416LH	\$42. ⁹⁵ EA

BATTERY APRON PLATE



A repair panel to re-enforce the section that gets eaten away around the battery.

Year	Description	Part No.	List
69-70	RH	C9ZZ-16052-P	\$29. ⁹⁵ EA

SHOCK TOWER AND APRON ASSEMBLY



A beautiful repair panel, this includes a complete front frame rail, full front and rear inner front fender aprons and

complete inner and outer shock tower. This piece will replace it all. Must be shipped by truck only.

Year	Description	Part No.	List
64-66	RH	C5ZZ-16054-RHC	\$574. ⁹⁵ EA
64-66	LH	C5ZZ-16055-LHC	\$574. ⁹⁵ EA
67-68	RH	C7ZZ-16054-RHC	\$574. ⁹⁵ EA
67-68	LH	C7ZZ-16055-LHC	\$574. ⁹⁵ EA
69-70	RH	C9ZZ-16054-RHC	\$574. ⁹⁵ EA
69-70	LH	C9ZZ-16055-LHC	\$574. ⁹⁵ EA

SHOCK TOWER WITH BRACKET



A welcomed reproduction part to replace those damaged towers. Painted black.

Year	Description	Part No.	List
65-66	RH	C5ZZ-6503438-C	\$129. ⁹⁵ EA
65-66	LH	C5ZZ-6503439-C	\$129. ⁹⁵ EA
67-68	RH	C7ZZ-6503438-C	\$129. ⁹⁵ EA
67-68	LH	C7ZZ-6503439-C	\$129. ⁹⁵ EA
69-70	RH	C9ZZ-6503438-C	\$129. ⁹⁵ EA
69-70	LH	C9ZZ-6503439-C	\$129. ⁹⁵ EA

INNER SHOCK TOWER PATCH



To replace the damaged or rusted lower shock tower.

Year	Part No.	List
64-66	M129	\$38. ⁹⁵ EA

SHOCK TOWER CAP



These precision crafted, steel stamped reproductions are perfect replacements for broken, bent or ugly originals. Each cap

contains both front shock nuts pressed into place.

Year	Description	Part No.	List
64-66	Black	C5ZZ-18A017-A	\$18. ⁹⁵ EA
64-66	Chrome	C5ZZ-18A017-C	\$24. ⁹⁵ EA
67-70	Black	C7ZZ-18A017-A	\$18. ⁹⁵ EA
67-70	Chrome	C7ZZ-18A017-C	\$24. ⁹⁵ EA

SHOP WITH CONFIDENCE! WE OFFER SUPERIOR-QUALITY PARTS FOR ALL YOUR MUSTANG RESTORATION NEEDS.

OUTER SHOCK TOWER



Stamped from 16 gauge steel with stronger 16 gauge one piece inner support welded in place.

Year	Description	Part No.	List
64-66	LH, Painted black	M125LH	\$44. ⁹⁵ EA
64-66	RH, Painted black	M125RH	\$44. ⁹⁵ EA
67-70	LH	M225LH	\$46. ⁹⁵ EA
67-70	RH	M225RH	\$46. ⁹⁵ EA

REAR FENDER APRON



Hood hinges bolt to these aprons. Made from heavy gauge steel.

Year	Description	Part No.	List
64-66	LH	M127LH	\$44. ⁹⁵ EA
64-66	RH	M127RH	\$44. ⁹⁵ EA
67-68	LH	M227LH	\$44. ⁹⁵ EA
67-68	RH	M227RH	\$44. ⁹⁵ EA
69-70	LH	M327LH	\$44. ⁹⁵ EA
69-70	RH	M327RH	\$44. ⁹⁵ EA
71-73	LH	M427LH	\$44. ⁹⁵ EA
71-73	RH	M427RH	\$44. ⁹⁵ EA

FENDER APRON BRACKET

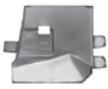

Attaches to cowl and back of fender apron.

Year	Description	Part No.	List
64-66	LH	M127ALH	\$16. ⁹⁵ EA
64-66	RH	M127ARH	\$16. ⁹⁵ EA
67-68	LH	M227ALH	\$26. ⁹⁵ EA
67-68	RH	M227ARH	\$26. ⁹⁵ EA
69-70	LH	M327ALH	\$18. ⁹⁵ EA
69-70	RH	M327ARH	\$18. ⁹⁵ EA

COWL COVERS



Scott Drake's Cowl Covers, help eliminate water, dirt, and leaves from entering through the cowl vent. The use of

Poly Methyl Methacrylate plastic (PMMA) helps prevent rusty cowls and soggy carpet that can lead to rusty floors.

Year	Part No.	Description	List
64-66	ACC-16741-65	1-Piece	\$29. ⁹⁵ EA
67-68	ACC-16741-67	2-Pieces	\$29. ⁹⁵ EA
69-70	ACC-16741-69	1-Piece	\$29. ⁹⁵ EA

FRAME CROSSMEMBER



Mount underneath oil pan connecting both frame rails together to reinforce front subframe assembly. Mounting bolts sold separately under part # 379068-S

Year	Description	Part No.	List
65-66	Front	C5ZZ-6510692-A	\$69. ⁹⁵ EA
67-68	Front	C7ZZ-6510692-A	\$69. ⁹⁵ EA

FRAME CROSSMEMBER BOLTS



Year	Part No.	List
64-70	379068-S	\$9. ⁹⁵ PR

FRONT FRAME RAIL

The best frame rail available. Gives the original appearance and strength when installed. Original style.



1965-70: 1 piece assembled
C7ZZ-6510218-B (RH)
C7ZZ-6510219-B (LH)

List

\$199.⁹⁵ EA



1964-70: 2 piece, inner & outer
MC124FRH (RH)
MC124FLH (LH)

List

\$199.⁹⁵ EA

OUTER FRONT FRAME RAIL



1964-67: outer only
MC124RH (RH)
MC124LH (LH)

List

\$79.⁹⁵ EA



1964-70: 31" Front patch, outer only
MC124ARH (RH)
MC124ALH (LH)

List

\$39.⁹⁵ EA

CONVERTIBLE INNER FRAME PATCH

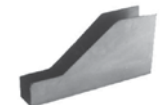

This improved part Year LH or RH. Made from high quality 14 gauge steel.

Year	Description	Part No.	List
64-70	RH or LH, 14 gauge steel	M122LR	\$32. ⁹⁵ EA

COWL GRILLE ASSEMBLY



Complete assembly

Year	Part No.	List
65-66	C5ZZ-6502010/28	\$409. ⁹⁵ EA
67-68	C7ZZ-6502010/28	\$409. ⁹⁵ EA
69-70	C9ZZ-6502010/28	\$409. ⁹⁵ EA

LOWER COWL PANEL



Year	Description	Part No.	List
67-68		C7ZZ-6502010-A	\$209. ⁹⁵ EA
69-70	Inner, w/ bracket	C9ZZ-6502010-A	\$224. ⁹⁵ EA

UPPER COWL PANEL



Year	Part No.	List
67-68	C7ZZ-6502228-A	\$224. ⁹⁵ EA
69-70	C9ZZ-6502228-A	\$224. ⁹⁵ EA

COWL SIDE PATCH PANEL



Year under the cowl and behind the wheelwell. Complete panels have opening for hinges. Patch panel pictured.

Year	Description	Part No.	List
64-68	LH, patch panel	M133LH	\$49. ⁹⁵ EA
64-68	RH, patch panel	M133RH	\$49. ⁹⁵ EA

COWL SIDE PANEL



Fits under the cowl and rearward of firewall. Complete panels have opening for hinges.

Year	Description	Part No.	List
64-66	LH, Complete	C5ZZ-6502043-L	\$44. ⁹⁵ EA
64-66	RH, Complete	C5ZZ-6502042-R	\$44. ⁹⁵ EA
67-68	LH, Complete	C7ZZ-6502043-L	\$49. ⁹⁵ EA
67-68	RH, Complete	C7ZZ-6502042-R	\$49. ⁹⁵ EA

OUTER COWL SIDE PANEL



This part commonly needs to be replaced on restoration projects due to rust damage over time.

Year	Description	Part No.	List
69-70	RH, Outer cowl side panel	C9ZZ-6502044-R	\$49. ⁹⁵ EA
69-70	LH, Outer cowl side panel	C9ZZ-6502045-L	\$49. ⁹⁵ EA

WE PROUDLY FEATURE AUTHENTIC MUSTANG REPRODUCTIONS FROM SCOTT DRAKE!



COWL VENT REPAIR KIT



For the frequently rusted cowl area. Kit includes sleeves, sealant, and instructions. Provides a watertight repair for this trouble area.

Year	Part No.	List
64-68	CSZZ-6502010-K	\$21.95 ^{KI}

COWL VENT REPAIR PANEL



This part commonly needs to be replaced on restoration projects due to rust damage over time. LH side requires minor modifications on 67-68.

Year	Description	Part No.	List
64-68	LH	M136LH	\$76.95 ^{EA}
64-68	RH	M136RH	\$76.95 ^{EA}

FULL FIREWALL



A nice reproduction stamping, ready to weld in place. Painted satin black. Convertibles require trimming.

Year	Description	Part No.	List
64-66	Fastback and coupe	M134	\$199.95 ^{EA}
67-68	Fastback and coupe	C7ZZ-6501605-FW	\$209.95 ^{EA}
69-70	Fastback and coupe	C9ZZ-6501605-FW	\$234.95 ^{EA}

PARTIAL FIREWALL OUTER



Year	Description	Part No.	List
64-68	LH	M134LH	\$51.95 ^{EA}
64-68	RH	M134RH	\$51.95 ^{EA}

FIREWALL INSULATOR



Features bonded thermal insulation. Mounting kit included.

Choose from die cut for a good fit or Molded for a perfect fit.

Year	Description	Part No.	List
64-66	Die-cut Economy	CSZZ-6501670-A	\$56.95 ^{EA}
67-68	Die-cut Economy	C7ZZ-6501670-A	\$56.95 ^{EA}
67-68	All Molded	C7ZZ-6501670-M	\$134.95 ^{EA}

SOUND DEADENER KIT



All made with die cut precision that makes them easy to install. Drastically reduces road noise and helps insulate your car from the heat and cold. Includes all pieces originally available for you particular year and bodystyle. Made from E.V.A. Our most complete kit. Kits include the following: L.H. and R.H. Front, Center Trans Hump, Rear Floor, Under Rear Seat, Transition and Trunk sections. 7 piece kit.

Year	Description	Part No.	List
64-68	Coupe	UL-CP	\$79.95 ^{KI}
69-73	Coupe	UL-CP-L	\$79.95 ^{KI}
64-68	Convertible	UL-CV	\$75.95 ^{KI}
69-73	Convertible	UL-CV-L	\$75.95 ^{KI}
65-68	Fastback	UL-FB	\$79.95 ^{KI}
69-73	Fastback	UL-FB-L	\$79.95 ^{KI}

MAGIC MAT INSULATION



This Premium Sound Deadening Insulation was originally developed for Military use in

Europe. Thick 2mm construction out performs leading Competitors that uses 1.7mm sheets. This material excels in insulating temperatures both hot and cold, sound proofing, noise dampening and eliminating resonance and vibrations. Very easy to apply self-adhesive 20" x 29" sheets that form to almost any contoured shapes and cuts easily with quality scissors or razor blade. Ideal for Floor Pans, Firewall, Doors, Roof and Trunks. Not affected by water or oil and adhesive it functional between -45c to 100c. This product is used in many high dollar European Cars and high dollar Car Audio installations and a great way to make your old Classic car more comfortable to ride in. Manufacturer is certified ISO 9001 and rated Q1 by Ford. Available in the standard Silver Foil as well as a Black Foil with an attractive pattern than can be left exposed such as the inside of trunk area. 9 large sheets per box for a total of 36 Square Feet.

Year	Description	Part No.	List
64-73	Silver Magic 2mm	UL-SM	\$114.95 ^{KIT}
64-73	Black Magic 2.3mm	UL-BM	\$119.95 ^{KIT}

FRONT FLOOR EXTENSION



Made from 19 gauge steel. Extension for where the front floor and the firewall pedal area end up. M126LH needs slight trimming on 1969-1970 if using the original torque box. No trimming is required if using a reproduction torque box, M114A.

Part No.	Year	Description	List
M126LH	64-68	LH	\$46.95 ^{EA}
M126RH	64-68	RH	\$46.95 ^{EA}

TORQUE BOX



To allow for complete clutch adjustment the left side has full original impression. High quality 14 gauge steel.

Year	Description	Part No.	List
67-68	Coupe/Fastback, LH	M114ALH	\$75.95 ^{EA}
67-70	Coupe/Fastback, RH	M114ARH	\$75.95 ^{EA}
64-68	Convertible, LH	M114LH	\$75.95 ^{EA}
64-68	Convertible, RH	M114RH	\$75.95 ^{EA}
69-70	Coupe/Fastback, LH	M114BLH	\$84.95 ^{EA}

INSULATION

UNDERHOOD INSULATION

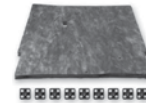

Rarely seen, as most cars with this option had been removed years ago. Helps reduce engine noise.

Year	Part No.	List
69-70	M274	\$42.50 ^{EA}

CARPET UNDERLAYMENT KIT



Kits include heavy duty die cut E.V.A. type rubber pad which aids against carpet ware, especially around sharp contoured floor areas. Helps insulate sound and temperature.

Year	Description	Part No.	List
64-73:	Coupe/Fastback, front and rear footwells	UL-1	\$42.95 ^{KI}
64-73:	Convertible, front and rear footwells	UL-3	\$42.95 ^{KI}



64-73: trans hump
UL-4

List
\$14.50 ^{EA}



65-68: Trunk
UL-5

List
\$16.95 ^{EA}

FLOORS & CHASIS

DRAIN HOLE COVER



Although interchangeable 1968-73 shape is different and come with smaller screws like original.

Year	Part No.	List
64-73	MM-111	\$3 ⁶⁵ EA
68-73	MM-111-68	\$3 ²⁵ EA

LONG FRONT FLOOR PAN



These floor pans will fit 1964 - 1973. They are exact replacements for 1964 - 1968. 1969 - 1970 cars have different

ribbing configurations. 1971 - 1973 cars can use but requires modifications.

Year	Description	Part No.	List
64-73	LH, 23"Wx38 3/4"L	M107LH	\$56 ⁹⁵ EA
64-73	RH, 23"Wx38 3/4L	M107RH	\$56 ⁹⁵ EA

COMPLETE FLOOR PAN KIT



Original gauge sheet metal is used in the manufacturing of this beautiful part, not thinner gauge offered by some. Made to exact specifications for a

perfect fit. Finished in a smooth semi-gloss black paint. Includes lower reinforcement pans on convertible, floor pan plugs and seat access hole plugs. 69-70 floor's front ribbing differs from original. Convertible pans do not have outboard lips as the originals, making for an easier install.

Complete Floor Pan Kit

Year	Description	Part No.	List
64-68	Coupe and Fastback, includes seat platforms, upper rear torque box patch, and rubber & metal plugs	M107-8-FFCP	\$414 ⁹⁵ KT
64-68	Convertible, includes lower pans,	M107-8-FFCV	\$414 ⁹⁵ KT
69-70	All body styles, includes seat platforms, upper rear torque box patch, and rubber & metal plugs *will fit 69-70 Conv w/ modification	M107-8-FFSTD	\$424 ⁹⁵ KT

Floor Pan Only

Year	Description	Part No.	List
64-68	Coupe and Fastback, Floor pan only	C5ZZ-6511135-FP	\$329 ⁹⁵ EA
64-68	Convertible, Floor pan only	C5ZZ-7611135-FP	\$329 ⁹⁵ EA
69-70	Coupe and Fastback, Floor pan only	C9ZZ-6511135-FP	\$324 ⁹⁵ EA

FULL LENGTH FLOOR PAN



Replace the whole side at once and save time. They are exact replacements for 1964-68. 1969-70 Mustangs have different

ribbing configurations. 1971-73 cars can use the 64-73 floor pans but requires modifications, therefore we recommend our new correct 71-73 pans.

Year	Description	Part No.	List
64-73	Coupe and Fastback, 24"Wx60"L, LH	M107-8ALH	\$98 ⁹⁵ EA
64-73	Coupe and Fastback, 24"Wx60"L, RH	M107-8ARH	\$98 ⁹⁵ EA
64-73	Convertible, 24"Wx60"L, LH	M107-8BLH	\$98 ⁹⁵ EA
64-73	Convertible, 24"Wx60"L, RH	M107-8BRH	\$98 ⁹⁵ EA
71-73	All, LH, painted black	M207-8LH	\$109 ⁹⁵ EA
71-73	All, RH, painted black	M207-8RH	\$109 ⁹⁵ EA

SHORT, FRONT FLOOR PAN



These floor pans will fit 1964 - 1973. They are exact replacements for 1964 - 1968. 1969 - 1970 cars have different

ribbing configurations. 1971 - 1973 cars can use but requires modifications.

Year	Description	Part No.	List
64-73	LH, 24"Wx22 1/2"L	M106LH	\$45 ⁹⁵ EA
64-73	RH, 24"Wx22 1/2"L	M106RH	\$45 ⁹⁵ EA

SEAT PLATFORM



Replace and re-enforce the mounting area for the seat.

Year	Description	Part No.	List
64-68	Coupe and Fastback, LH	M132LH	\$59 ⁹⁵ EA
64-68	Coupe and Fastback, RH	M132RH	\$59 ⁹⁵ EA
69-70	Fastback, LH	M232LH	\$69 ⁹⁵ EA
69-70	Fastback, RH	M232RH	\$69 ⁹⁵ EA

CONVERTIBLE SEAT PLATFORM



To repair that rusty or damaged seat platform. Not concours for 69-70

Year	Description	Part No.	List
64-70	Convertible	M132CV	\$119 ⁹⁵ EA

CONVERTIBLE REINFORCEMENT PAN



Add structural strength to your convertible, seat holes are already drilled.

Year	Description	Part No.	List
64-68	LH, raw steel	M120LH	\$79 ⁹⁵ EA
64-68	RH, raw steel	M120RH	\$79 ⁹⁵ EA

CONVERTIBLE REINFORCEMENT PLATE



Bolts to lower pans for added strength.

Year	Part No.	List
64-68	C5ZZ-7610962	\$51 ⁹⁵ EA

FLOOR PAN SUPPORT



Heavy duty floor support that connects inner floor frame supports. The transmission crossmember bolts to this.

Year	Part No.	List
64-66	C5ZZ-6510692-B	\$69 ⁹⁵ EA
67-68	C7ZZ-6510692-B	\$69 ⁹⁵ EA

TRANSMISSION SUPPORT



Part No.	Year	Description	List
C5ZZ-6A203-A	65-66	All	\$52 ⁹⁵ EA
C7ZZ-6A203-A	67-68	Small block & 6-cylinder	\$52 ⁹⁵ EA
C7ZZ-7A383-B	67-70	C6 Automatic	\$129 ⁹⁵ EA

INNER FLOOR FRAME SUPPORT



Supports have sharp bends with good definition. 14 gauge adds strength.

Part No.	Year	Description	List
M121	64-68	Coupe and Fastback, 4"W x 27/8"H x 29"L	\$44 ⁹⁵ EA
M121-69	69-70	Coupe and Fastback	\$99 ⁹⁵ PR
M121A	64-68	Convertible, 4"W x 27/8"H x 29"L	\$44 ⁹⁵ EA
M221LH	71-73	LH	\$39 ⁹⁵ EA
M221RH	71-73	RH	\$39 ⁹⁵ EA

WE PROUDLY FEATURE AUTHENTIC MUSTANG REPRODUCTIONS FROM SCOTT DRAKE!



REAR FLOOR PAN



These floor pans will fit 1964 - 1973. They are exact replacements for 1964 - 1968. 1969 - 1970 cars have different ribbing configurations. 1971 - 1973 cars can use but requires modifications.

Year	Description	Part No.	List
64-73	LH, 23 1/2"Wx21"L	M108LH	\$56. ⁹⁵ EA
64-73	RH, 23 1/2"Wx21"L	M108RH	\$56. ⁹⁵ EA

SEAT BELT ANCHOR PLATE



Now you can replace this original part, which is commonly striped out, with a nice reproduction. Must be welded to rear floor pan.

Year	Description	Part No.	List
64-73	Weld in place	CSZZ-61216	\$7. ⁵⁰ EA

COMPLETE ROCKER PANELS

Renew the structural strength of your Mustang. These Rocker Panels feature a new design now with thicker metal! The only ones using internal reinforcement braces like originals. Also feature rockers' original radius not sharp bends.



Year	Description	Part No.	List
64-66	Fastback/Coupe, Complete RH	CSZZ-6510128	\$159. ⁹⁵ EA
64-66	Fastback/Coupe, Complete LH	CSZZ-6510129	\$159. ⁹⁵ EA
67-68	Fastback/Coupe, Complete RH	CSZZ-6510128-A	\$159. ⁹⁵ EA
67-68	Fastback/Coupe, Complete LH	CSZZ-6510129-A	\$159. ⁹⁵ EA



Year	Description	Part No.	List
64-66	Convertible, Complete RH	CSZZ-7610128-C	\$219. ⁹⁵ EA
64-66	Convertible, Complete LH	CSZZ-7610129-C	\$219. ⁹⁵ EA
67-68	Convertible, Complete RH	C7ZZ-7610128-C	\$214. ⁹⁵ EA
67-68	Convertible, Complete LH	C7ZZ-7610129-C	\$214. ⁹⁵ EA

INNER ROCKER PANELS



Year	Description	Part No.	List
69-73	Convertible, inner LH	M112ALH	\$149. ⁹⁵ EA
69-73	Convertible, inner RH	M112ARH	\$149. ⁹⁵ EA



Year	Description	Part No.	List
64-68	Convertible, inner LH 6"W x 2 5/8"H x 75"L	M112LH	\$77. ⁵⁰ EA
64-68	Convertible, inner RH 6"W x 2 5/8"H x 75"L	M112RH	\$77. ⁵⁰ EA



Year	Description	Part No.	List
64-68	Lower front patch, LH	M141LH	\$55. ⁹⁵ EA
64-68	Lower front patch, RH	M141RH	\$55. ⁹⁵ EA

OUTER ROCKER PANELS



Year	Description	Part No.	List
64-66	Outer only RH	CSZZ-6510128-0	\$89. ⁹⁵ EA
64-66	Outer only LH	CSZZ-6510129-0	\$89. ⁹⁵ EA

UPPER REAR TORQUE BOX



To replace or patch the upper torque box.

Year	Description	Part No.	List
64-68	LH	M130LH	\$42. ⁹⁵ EA
64-68	RH	M130RH	\$42. ⁹⁵ EA

REAR TORQUE BOX PATCH



Complete for frame rail over the rear axle. Welded into one piece like original.

Year	Description	Part No.	List
64-70	Convertible, LH	MM102CLH	\$219. ⁹⁵ EA
64-70	Convertible, RH	cMM102CLH	\$219. ⁹⁵ EA
64-70	Coupe, LH	MM102LH	\$219. ⁹⁵ EA
64-70	Coupe, RH	MM102RH	\$219. ⁹⁵ EA

REAR FRAME RAIL WITH TORQUE BOX



Made in the USA, these frame rails consists of a 3 sections welded together and reinforced with internal

gussets at joints for extra strength, these also include torque box attached to save labor, and are shipped in raw steel.

Year	Description	Part No.	List
64-68	Convertible, RH	MM102-A-103BRH	\$289. ⁹⁵ EA
64-68	Convertible, LH	MM102-A-103BLH	\$289. ⁹⁵ EA
64-68	Coupe and Fastback, RH	MM102-A-103RH	\$289. ⁹⁵ EA
64-68	Coupe and Fastback, LH	MM102-A-103LH	\$289. ⁹⁵ EA
69-70	Coupe and Fastback, RH	MM302-A-103HR	\$314. ⁹⁵ EA
69-70	Coupe and Fastback, LH	MM302-A-103HL	\$314. ⁹⁵ EA

FULL REAR FRAME RAIL



We also offer a new version that is frame rail stamped as one complete piece like

originals. Painted black. Torque Box included, but not attached.

Year	Description	Part No.	List
65-68	CP & FB, RH, concours	CSZZ-6510124NTB	\$249. ⁹⁵ EA
65-68	CP & FB, LH, concours	CSZZ-6510125NTB	\$249. ⁹⁵ EA
65-68	CV, RH, concours	CSZZ-7610125-KR	\$259. ⁹⁵ EA
65-68	CV, LH, concours	CSZZ-7610125-KL	\$259. ⁹⁵ EA

OVER AXLE FRAME RAIL



Curved part of frame over the differential, right or left hand.

Year	Description	Part No.	List
64-69	24" long, RH or LH.	MM102	\$79. ⁹⁵ EA

REAR FRAME RAIL PATCH



Gives the original appearance and strength when installed. Original style.

Year	Description	Part No.	List
64-70	4"W x 5"H x 29-1/2"L, LH	M103ALH	\$56. ⁹⁵ EA
64-70	4"W x 5"H x 29-1/2"L, RH	M103ARH	\$56. ⁹⁵ EA

REAR FLOOR EXTENSION



Extension from rear floor to trunk. Specifically designed for coupes and Fastbacks, but will work for convertibles with slight trimming.

Year	Description	Part No.	List
64-68	LH	M131LH	\$46.50 ^{EA}
64-68	RH	M131RH	\$46.50 ^{EA}

FASTBACK REAR SEAT BOTTOM BRACKET



These are the catch brackets that allow the Fastback rear seat bottom to securely snap into position. Welds to floor plan.

Year	Description	Part No.	List
65-70	Rear seat bottom catch	M131-FB	\$19.95 ^{PR}

TRANSITION PAN



Original gauge sheet metal is used in the manufacturing of this beautiful part. Made to exact specifications for a perfect fit. Finished in a smooth semi-gloss black paint. Shock mounts are included.

Year	Description	Part No.	List
64-68	W/ shock mounts	M3649	\$264.95 ^{EA}

TRUNK PANEL



Goes between the fuel tank and the rear seat in the trunk area.

Part No.	Year	List
M135TP	64-68	\$35.95 ^{EA}

TRUNK DIVIDER AND PACKAGE SHELF

Replacement sheetmetal for behind rear seat. Original package tray with upgraded steel rear seat divider for coupes.



67-68: Fastback
C7ZZ-6346610-A

List
\$259.95^{EA}



Year	Description	Part No.	List
69-70	Fastback	C9ZZ-6346510-A	\$199.95 ^{SET}

TRUNK FLOOR



Year	Description	Part No.	List
64-70	Economy, RH	C5ZZ-6511218-A	\$34.95 ^{EA}
64-70	Economy, LH	C5ZZ-6511219-A	\$34.95 ^{EA}
64-70	Heavy Gauge, RH	C5ZZ-6511218-C	\$44.95 ^{EA}
64-70	Heavy Gauge, LH	C5ZZ-6511219-C	\$44.95 ^{EA}

TRUNK FLOOR DROP OFF



This drop off meets the bottom section of the quarter panel. Overlaps the trunk floor 1".

This is included when buying a trunk floor. MADE IN THE USA. 1969 - 1970 requires trimming.

Year	Description	Part No.	List
64-70	LH, 21"Wx9"L	M109LH	\$19.95 ^{EA}
64-70	RH, 21"Wx9"L	M109RH	\$19.95 ^{EA}
71-73	LH, 20 1/4"Wx9"L	M409LH	\$23.95 ^{EA}
71-73	RH, 20 1/4"Wx9"L	M409RH	\$23.95 ^{EA}



1971-73: 54"W X 38"L, complete M438

List
\$179.95^{EA}

DOOR, ROOF & QTR PANEL

COMPLETE DOOR SHELL



Brand new tooling! Good fit, this part offers an alternative to expensive, and hard to find, used doors.

Year	Description	Part No.	List
64-66	RH	C5ZZ-6520124-B	\$274.95 ^{EA}
64-66	LH	C5ZZ-6520125-B	\$274.95 ^{EA}
67-68	RH	C7ZZ-6520124-B	\$334.95 ^{EA}
67-68	LH	C7ZZ-6520125-B	\$334.95 ^{EA}
69-70	RH	D0ZZ-6520124-A	\$359.95 ^{EA}
69-70	LH	D0ZZ-6520125-A	\$359.95 ^{EA}

DOOR SKIN



A good quality reproduction Door Skin. Painted black. Ready to install.

Year	Description	Part No.	List
64-66	RH	C5ZZ-6520200-A	\$69.95 ^{EA}
64-66	LH	C5ZZ-6520201-A	\$69.95 ^{EA}
67-68	RH	C7ZZ-6520200-A	\$84.95 ^{EA}
67-68	LH	C7ZZ-6520201-A	\$84.95 ^{EA}
69-70	RH	C9ZZ-6520200-A	\$129.95 ^{EA}
69-70	LH	C9ZZ-6520201-A	\$129.95 ^{EA}

LOWER DOOR SKIN



Repairs lower section of door. Full length 47"L x 8"H.

Year	Description	Part No.	List
64-66	LH	M110LH	\$56.95 ^{EA}
64-66	RH	M110RH	\$56.95 ^{EA}

FASTBACK ROOF PANEL



Complete Fastback roof panels. Includes outer frame work underneath. Does not include front or rear brace.

Year	Description	Part No.	List
65-66		C5ZZ-6350202-A	\$420.95 ^{EA}
67-68		C7ZZ-6350202-A	\$420.95 ^{EA}
69-70		C9ZZ-6350202-A	\$420.95 ^{EA}

ROOF BRACE FRONT



Front support brace for the roof on coupes and fastbacks

Year	Description	Part No.	List
65-68	Front CP/FB	C5ZZ-6552103-A	\$75.95 ^{EA}

ROOF BRACE REAR



Support brace for the rear of the roof

Year	Description	Part No.	List
67-68	Fastback	C7ZZ-6552104-A	\$94.95 ^{EA}

Sheet Metal

WE PROUDLY FEATURE AUTHENTIC MUSTANG REPRODUCTIONS FROM SCOTT DRAKE!



UPPER QUARTER VENT LOUVERS



Year	Part No.	List
67-68	C7ZZ-63280B62-K	\$399 ⁹⁵ EA

COMPLETE TRUNK FLOOR



These are quality, steel replacements. These are complete trunk floors. Includes drop offs. Year specific bumper bracket sold separately now with weld through primer.

Year	Description	Part No.	List
64-70	Complete	CSZZ-6511215-A	\$398 ⁹⁵ EA

REAR CROSS MEMBER



This brace is often damaged when rear-ended. Attaches to tail light panel. Gas tank rests on lip. Convertibles require additional bracing.

Year	Description	Part No.	List
64-70	Economy	CSZZ-7610780-BR	\$22 ⁹⁵ EA
64-70	Concours - Heavy gauge	CSZZ-7610780-AR	\$34 ⁹⁵ EA

CONVERTIBLE TRUNK BRACE & CROSS MEMBER

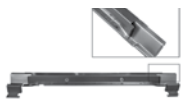

This set includes the Mustang rear cross member and convertible trunk brace pre-assembled for easy installation. Also includes LH and RH brace pieces.

Year	Part No.	List
64-70	CSZZ-7610780-B	\$79 ⁹⁵ ST

CONVERTIBLE TRUNK BRACE



For best results when replacing the crossmember, it is best to replace these pieces as well.

Year	Description	Part No.	List
64-70	Center piece only	M135A	\$32 ⁹⁵ EA
64-70	LH only	M135ALC	\$22 ⁹⁵ EA
64-70	RH only	M135ARC	\$22 ⁹⁵ EA

TRUNK BUMPER BRACE



Gives added strength to the trunk floor.

Year	Description	Part No.	List
64-66	LH	MM134BL	\$20 ⁹⁵ EA
64-66	RH	MM134BR	\$20 ⁹⁵ EA
67-68	RH or LH	MM634LR	\$21 ⁹⁵ EA
69-70	LH	MM667LH	\$21 ⁹⁵ EA
69-70	RH	MM667LH	\$21 ⁹⁵ EA

QUARTER PANEL ASSEMBLY



These reproduction quarter panels offer an affordable replacement for this most complicated of body panels. Shipped lacquered black for corrosion protection prior to installation.

Year	Description	Part No.	List
64-66	CP, RH	CSZZ-6527846-BR	\$174 ⁹⁵ EA
64-66	CP, LH	CSZZ-6527847-BR	\$174 ⁹⁵ EA
64-66	CV, RH	CSZZ-7627846-AR	\$174 ⁹⁵ EA
64-66	CV, LH	CSZZ-7627847-AR	\$174 ⁹⁵ EA
65-66	FB, RH (1 piece)	CSZZ-6327846-C	\$409 ⁹⁵ EA
65-66	FB, LH (1 piece)	CSZZ-6327847-C	\$409 ⁹⁵ EA
67	CP, RH (w/ louver holes)	C7ZZ-6527846-A	\$259 ⁹⁵ EA
67	CP, LH (w/ louver holes)	C7ZZ-6527847-A	\$259 ⁹⁵ EA
67	CV, RH (w/ louver holes)	C7ZZ-7627846-C	\$294 ⁹⁵ EA
67	CV, LH (w/ louver holes)	C7ZZ-7627847-C	\$294 ⁹⁵ EA
67	FB, RH (1 piece)	C7ZZ-6327846-CR	\$399 ⁹⁵ EA
67	FB, LH (1 piece)	C7ZZ-6327847-CR	\$399 ⁹⁵ EA
68	CP, RH (w/out indent)	C8ZZ-6527846-A	\$259 ⁹⁵ EA
68	CP, LH (w/out indent)	C8ZZ-6527847-A	\$259 ⁹⁵ EA
68	CV, RH (w/ indent)	C8ZZ-7627846-A	\$294 ⁹⁵ EA
68	CV, LH (w/ indent)	C8ZZ-7627847-A	\$294 ⁹⁵ EA
68	CV, RH (w/out indent)	C8ZZ-7627846-B	\$- EA
68	CV, LH (w/out indent)	C8ZZ-7627847-B	\$294 ⁹⁵ EA
68	FB, RH	C8ZZ-6327846-A	\$399 ⁹⁵ EA
68	FB, LH	C8ZZ-6327847-A	\$399 ⁹⁵ EA
69	FB, RH	C9ZZ-6327846-CR	\$399 ⁹⁵ EA
69	FB, LH	C9ZZ-6327847-CR	\$399 ⁹⁵ EA
70	FB, RH	D0ZZ-6327846-A	\$409 ⁹⁵ EA
70	FB, LH	D0ZZ-6327847-A	\$409 ⁹⁵ EA

FULL QUARTER PANEL REPLACEMENT



This is a new high quality stamped steel quarter panel replacement for

1969 Mustang Convertibles. This is a full quarter panel and it installs utilizing the factory attaching points for a precise factory fit. Each panel features the correct accent line, side marker hole and recessed pocket for quarter panel ornaments. Panel is finished in black primer ready for prep and paint.

Year	Description	Part No.	List
1969	RH	C9ZZ-7627846-AR	\$379 ⁹⁵ EA
1969	LH	C9ZZ-7627847-AR	\$379 ⁹⁵ EA

QUARTER PANEL SKIN



Our replacement skins eliminate much of the demolition work that accompanies complete quarter panel replacement.

Year	Description	Part No.	List
65-66	RH	CSZZ-6527846-S	\$79 ⁹⁵ EA
65-66	LH	CSZZ-6527847-S	\$79 ⁹⁵ EA
67-68	RH (w/out holes)	C7ZZ-6527840-S	\$89 ⁹⁵ EA
67-68	LH (w/out holes)	C7ZZ-6527841-S	\$89 ⁹⁵ EA
69-70	FB, RH (w/out any holes)	C9ZZ-6327840-S	\$99 ⁹⁵ EA
69-70	FB, LH (w/out any holes)	C9ZZ-6327841-S	\$99 ⁹⁵ EA
69	CP/CV, RH	C9ZZ-6527840-S	\$102 ⁹⁵ EA
69	CP/CV, LH	C9ZZ-6527841-S	\$102 ⁹⁵ EA
70	CV, RH (Modify for CP)	D0ZZ-6527840-S	\$102 ⁹⁵ EA
70	CV, LH (Modify for CP)	D0ZZ-6527841-S	\$102 ⁹⁵ EA
71-72	CP/CV, RH	D1ZZ-6527846-S	\$102 ⁹⁵ EA
71-72	CP/CV, LH	D1ZZ-6527847-S	\$102 ⁹⁵ EA
73	FB, RH	D3ZZ-6327846-S	\$104 ⁹⁵ EA
73	FB, LH	D3ZZ-6327847-S	\$104 ⁹⁵ EA

LOWER PANEL IN FRONT OF REAR WHEEL



Lower portion of wheel opening with bottom and front edge included

Year	Description	Part No.	List
64-66	LH	M102ALH	\$21 ⁹⁵ EA
64-66	RH	M102ARH	\$21 ⁹⁵ EA

SHOP WITH CONFIDENCE! WE OFFER SUPERIOR-QUALITY PARTS FOR ALL YOUR MUSTANG RESTORATION NEEDS.

LOWER REAR QUARTER PANEL



Covers the lower rear section of the quarter panel. Has pressed-in seams on the bottom and has the contour of the wheel opening. Also has an offset on the top edge for installation.

Year	Description	Part No.	List
64-66	LH	M100ALH	\$39.95 ^{EA}
64-66	RH	M100ARH	\$39.95 ^{EA}
67-68	LH	M200LH	\$39.95 ^{EA}
67-68	RH	M200RH	\$39.95 ^{EA}
69-70	LH, Fastback	M300ALH	\$57.50 ^{EA}
69-70	RH, Fastback	M300ARH	\$57.50 ^{EA}
69-70	LH, coupe/convertible	M300LH	\$57.50 ^{EA}
69-70	RH, coupe/convertible	M300RH	\$57.50 ^{EA}
71-73	LH	M400LH	\$67.50 ^{EA}
71-73	RH	M400RH	\$67.50 ^{EA}

PARTIAL QUARTER PANEL



Longer version of the rear wheel flares. Extends all the way to the door jamb and overlaps 1".

Year	Description	Part No.	List
64-66	LH	M101ALH	\$68.95 ^{EA}
64-66	RH	M101ARH	\$68.95 ^{EA}
67-68	LH	M201ALH	\$65.95 ^{EA}
67-68	RH	M201ARH	\$65.95 ^{EA}
71-73	LH	M401LH	\$73.95 ^{EA}
71-73	RH	M401RH	\$73.95 ^{EA}

REAR WHEEL FLARE



Covers the upper section of the wheel opening. Offset on top edge for easier installation. Overlaps the lower rear quarter when both are used.

Year	Description	Part No.	List
69-70	LH	M301LH	\$58.95 ^{EA}
69-70	RH	M301RH	\$58.95 ^{EA}

COMPLETE WHEELHOUSE



Previously available only separately, these complete wheel housings are made of high quality, formed sheet metal. Finished in black satin paint for corrosion protection. Available in right and left sides.

Year	Description	Part No.	List
65-66	RH, CP/FB	CSZZ-6527886/94	\$164.95 ^{EA}
65-66	LH, CP/FB	CSZZ-6527887/95	\$164.95 ^{EA}
64-66	RH, Conv	CSZZ-7627886/94	\$174.95 ^{EA}
64-66	LH, Conv	CSZZ-7627887/95	\$174.95 ^{EA}
67-68	RH, CP/FB	C7ZZ-6527886/94	\$164.95 ^{EA}

Year	Description	Part No.	List
67-68	LH, CP/FB	C7ZZ-6527887/95	\$164.95 ^{EA}
67-68	RH, Conv	C7ZZ-7627886/94	\$174.95 ^{EA}
67-68	LH, Conv	C7ZZ-7627887/95	\$174.95 ^{EA}
69-70	RH, CP/FB	C9ZZ-6527886/94	\$169.95 ^{EA}
69-70	LH, CP/FB	C9ZZ-6527887/95	\$169.95 ^{EA}

INNER WHEELHOUSE



Fits coupe and fastback, must be modified for convertible to allow the top to nest properly. The seam needs to be bent over and the inner section flattened slightly

Year	Description	Part No.	List
64-70	RH	CSZZ-6527886-A	\$59.95 ^{EA}
64-70	LH	CSZZ-6527887-A	\$59.95 ^{EA}
71-73	LH	D1ZZ-6527887-A	\$79.95 ^{EA}
71-73	RH	D1ZZ-6527886-A	\$79.95 ^{EA}

OUTER WHEELHOUSE



A quality stamping now available.

Year	Description	Part No.	List
64-66	LH	M113LH	\$56.95 ^{EA}
64-66	RH	M113RH	\$56.95 ^{EA}
67-68	LH	M213LH	\$61.95 ^{EA}
67-68	RH	M213RH	\$61.95 ^{EA}
69-70	LH	M313LH	\$61.95 ^{EA}
69-70	RH	M313RH	\$61.95 ^{EA}
71-73	LH	M413LH	\$81.95 ^{EA}
71-73	RH	M413RH	\$81.95 ^{EA}

PARTIAL OUTER WHEELHOUSE



Rear section of outer wheelhouse, a commonly rusted area.

Year	Description	Part No.	List
64-66	LH	M113ALH	\$42.95 ^{EA}
64-66	RH	M113ARH	\$42.95 ^{EA}

QUARTER PANEL EXTENSION



Quarter Panel Extension

Year	Description	Part No.	List
64-66	RH	CSZZ-6527702-A	\$49.95 ^{EA}
64-66	LH	CSZZ-6527703-A	\$49.95 ^{EA}
67-68	RH Coupe/Conv	C7ZZ-6527702-A	\$55.95 ^{EA}
67-68	LH Coupe/Conv	C7ZZ-6527703-A	\$55.95 ^{EA}
67-68	RH Fastback	C7ZZ-6327702-A	\$59.95 ^{EA}
67-68	LH Fastback	C7ZZ-6327703-A	\$59.95 ^{EA}

Year	Description	Part No.	List
69	RH Fastback	C9ZZ-6328010-A	\$129.95 ^{EA}
69	LH Fastback	C9ZZ-6328011-A	\$129.95 ^{EA}
70	RH Fastback	D0ZZ-6328010-A	\$129.95 ^{EA}
70	LH Fastback	D0ZZ-6328011-A	\$129.95 ^{EA}
71-73	RH Fastback	D1ZZ-6328010-A	\$104.95 ^{EA}
71-73	LH Fastback	D1ZZ-6328011-A	\$104.95 ^{EA}

QUARTER PANEL EXTENSION NUT



Year	Description	Part No.	List
64-68	Set of 6	373556-S	\$6.00 ST

TRUNK REAR CORNER



Corner pieces for where the quarter panel and taillight meet. Part of the rain gutter. Important replacement when changing the quarter panels. Coupes and convertibles only.

Year	Description	Part No.	List
64-66	Coupe and convertible, LH	M142LH	\$26.95 ^{EA}
64-66	Coupe and convertible, RH	M142RH	\$26.95 ^{EA}
67-68	Coupe and convertible, LH	M242LH	\$24.95 ^{EA}
67-68	Coupe and convertible, RH	M242RH	\$24.95 ^{EA}
67-68	Fastback, LH	M242LH-FB	\$24.95 ^{EA}
67-68	Fastback, RH	M242RH-FB	\$24.95 ^{EA}

FASTBACK REAR QUARTER PANEL BRACKET



Year	Description	Part No.	List
65-66	RH	CSZZ-6328058-A	\$56.95 ^{EA}
65-66	LH	CSZZ-6328059-A	\$56.95 ^{EA}

FASTBACK TAIL LIGHT PANEL BRACKET



Panel to secure tail light panel to quarter panel.

Year	Description	Part No.	List
67-68	Fastback, RH	C7ZZ-6328058-A	\$46.95 ^{EA}
67-68	Fastback, LH	C7ZZ-6328059-A	\$46.95 ^{EA}
69-70	Fastback, RH	C9ZZ-6328058-A	\$48.95 ^{EA}
69-70	Fastback, LH	C9ZZ-6328059-A	\$48.95 ^{EA}

WE PROUDLY FEATURE AUTHENTIC MUSTANG REPRODUCTIONS FROM SCOTT DRAKE!



TAIL LIGHT PANEL



Carefully formed to facilitate a painless replacement,

these panels offer an affordable repair for damaged originals.

Year	Description	Part No.	List
64-66	OEM tooling	C6ZZ-6540324-A	\$124. ⁹⁵ EA
64-66	USA made	C6ZZ-6540324-AR	\$79. ⁹⁵ EA
64-66	Quality Import	C6ZZ-6540324-AT	\$79. ⁹⁵ EA
67-68		C7ZZ-6540324-AR	\$82. ⁹⁵ EA
67-68	Use with Cougar lights	S7MS-6540324-A	\$219. ⁹⁵ EA
68	Use w/ Shelby lights	C8ZX-6540324	\$219. ⁹⁵ EA
69		C9ZZ-6540324-AR	\$154. ⁹⁵ EA
70		D0ZZ-6540324-BR	\$129. ⁹⁵ EA
71-73		D1ZZ-6540324-AR	\$129. ⁹⁵ EA

TAIL LIGHT PANEL WITH CORNERS



Includes Coupe/Convertible trunk corner unattached.

Year	Description	Part No.	List
67-68	Coupe & Convertible	C7ZZ-6540324-K	\$99. ⁹⁵ EA

TAIL LIGHT PANEL BRACKET AND BRACE

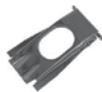

Must be welded in to place. Painted black to resist corrosion.

Year	Description	Part No.	List
64-66	Coupe and Fastback	C5ZZ-6543236-A	\$30. ⁹⁵ EA
64-66	Convertible	C5ZZ-7643235-A	\$30. ⁹⁵ EA
67-68		C7ZZ-6543236-A	\$33. ⁹⁵ EA
69-70		D0ZZ-6543236-A	\$36. ⁹⁵ EA

REAR VALANCE



These stampings are painted black

for corrosion protection.

Year	Description	Part No.	List
64-66	No holes	C5ZZ-6540544-AR	\$42. ⁹⁵ EA
64-66	W/ backup light holes	C5ZZ-6540544-BR	\$42. ⁹⁵ EA
65-66	GT	C5ZZ-6540544-CR	\$42. ⁹⁵ EA
65-66	GT w/ back up light holes	C5ZZ-6540544-DR	\$42. ⁹⁵ EA
67-68		C7ZZ-6540544-CR	\$42. ⁹⁵ EA
67-68	GT	C7ZZ-6540544-DR	\$42. ⁹⁵ EA
69-70		C9ZZ-6540544-AR	\$69. ⁹⁵ EA

Year	Description	Part No.	List
69-70	GT / Mach 1	C9ZZ-6540544-BR	\$69. ⁹⁵ EA
71-73		D1ZZ-6540544-AR	\$69. ⁹⁵ EA
71-73	Mach 1	D1ZZ-6540544-BR	\$69. ⁹⁵ EA

FASTBACK TRUNK LID FILL PANEL



This commonly rusted part Year between the rear window and the trunk lid. Finished in semi-gloss primer epoxy.

Year	Description	Part No.	List
65-66		C5ZZ-6340310-A	\$86. ⁹⁵ EA
69-70		M-328-FB	\$72. ⁵⁰ EA
67-68		M3647	\$72. ⁵⁰ EA

PANEL BEHIND REAR WINDOW



This commonly rusted part Year between the rear window and the trunk lid. Finished in semi-gloss epoxy primer.

Year	Description	Part No.	List
64-66	Coupe	M128-CP	\$59. ⁹⁵ EA
64-66	Convertible	M128	\$64. ⁹⁵ EA
67-68	Coupe	M228-CP	\$69. ⁹⁵ EA
67-68	Convertible	M228	\$94. ⁹⁵ EA

TRUNK LID



Good quality import Trunk Lid. Ready to paint and install.

Year	Description	Part No.	List
65-66	Fastback	C5ZZ-6340110-A	\$159. ⁹⁵ EA
64-66	Coupe and convertible	C5ZZ-6540110-CR	\$174. ⁹⁵ EA
67-68	Fastback	C7ZZ-6340110-AR	\$179. ⁹⁵ EA
67-68	Coupe and convertible	C7ZZ-6540110-CR	\$189. ⁹⁵ EA
69-70	Fastback	C9ZZ-6340110-CR	\$189. ⁹⁵ EA

TRUNK LID HINGE



Now you can replace those bent, and or rusted trunk hinges and get the original fit and alignment. Sold as a pair.

Year	Description	Part No.	List
67-68	Fastback	C7ZZ-6342700/1A	\$124. ⁹⁵ PR
69-70	Fastback	C9ZZ-6342700/1A	\$129. ⁹⁵ PR

TRUNK LID SPRINGS

These torsion bars are made from spring steel and when properly installed will keep the trunk lid open.

Year	Description	Part No.	List
65-66	Fastback	C5ZZ-6344890-A	\$22. ⁹⁵ EA
64-68	Coupe/Conv	C5ZZ-6544890/1	\$38. ⁹⁵ PR

TRUNK LID PROP ROD



Our steel prop rod is zinc plated for years of service. We include the storage clip and the retaining clip for a

quick and complete installation. A must when using a rear spoiler.

Year	Part No.	List
69-70	C9ZZ-6344206	\$29. ⁹⁵ SE

TAIL LIGHT HONEYCOMB PANEL



All new tooling, this panel is made from high quality ABS

plastic injection.

Year	Description	Part No.	List
70	Dark Argent	D0ZZ-63423B70	\$104. ⁹⁵ EA
71-73	Black	D1ZZ-63423B70	\$110. ⁰⁰ EA

TAIL LIGHT HONEYCOMB PANEL

MOLDING CLIPS



These 12 special retaining clips are used to mount the Tail Lamp Panel Moldings on all 70-73 Mach 1's. Retaining nuts are not included.

Year	Part No.	List
70-73	D0GY-65291B80-A	\$19. ⁹⁵ ST

REAR WINDOW LOUVER KIT



Complete kit includes louvers, hinges, latches, gaskets and pads.

Year	Part No.	List
69-70	C9ZZ-6344268-K	\$449. ⁹⁵ KI

REAR WINDOW LOUVER PADS



Gaskets or pads to protect the paint when installing the rear window louvers.

Year	Description	Part No.	List
69-70	6 pieces	C9ZZ-6344268	\$22. ⁹⁵ KI

REAR WINDOW LOUVER SEAL



Seals and insulates the rear window louvers to the car.

Year	Part No.	List
69-70	C9ZZ-6344268-S	\$24. ⁹⁵ EA

REAR WINDOW LOUVER UPPER HINGES



Hinges to attach the rear louvers and allow them to be raised for cleaning. Polished chrome finish.

Year	Part No.	List
69-70	C9ZZ-6344268-H	\$85.95 ^{PR}

REAR WINDOW LOUVER BOTTOM LATCH



These are very nice reproductions. Sold in pairs.

Year	Part No.	List
69-70	C9ZZ-6344268-L	\$84.95 ^{PR}

REAR SPOILER



This wing is made of strong fiberglass. Finished smooth with dull Black paint. Complete kit includes Spoiler, pedestals, pads & mounting hardware. Don't forget prop rod.

Year	Part No.	List
69-70	C9ZZ-6344210-K	\$174.95 ^{SE}
71-73	D1ZZ-6344210-K	\$174.95 ^{SE}

REAR SPOILER MOUNTING BRACKET



Brackets used to mount the rear spoiler to the deck lid.

Year	Part No.	List
69-70	C9ZZ-6344220-B	\$32.95 ^{PR}

REAR SPOILER MOUNTING GASKET



Now made by Scott Drake. Our gaskets are made of high quality EPDM rubber to provide years of service. Not just a flat piece of rubber. These pads are formed to fit the slope of the trunk lid. Sold in matching pairs

Year	Part No.	List
69-73	C9ZZ-6344228/9A	\$11.95 ^{PR}

REAR SPOILER MOUNTING HARDWARE KIT



The bases are made from our own tooling with high quality zinc. Our

kit also features stainless steel and zinc plated hardware for years of service. The pads are a Scott Drake exclusive and made of high quality EPDM rubber. Also available for 1971-73 applications.

Year	Part No.	List
69-70	C9ZZ-6344210-HD	\$49.95 ^{KI}
71-73	D1ZZ-6344210-HD	\$49.95 ^{KI}

TRUNK LID AND QUARTER EXTENSIONS

Trunk lid and quarter panel extensions for Shelby and California Special. Reproduced just like original.



Year	Description	Part No.	List
67-68	Shelby Convertible & California Special	C8ZX-6540110-K	\$649.95 ^{KT}
67-68	Fastback, trunk lid only	S7MS-6340110-K	\$399.95 ^{EA}
67-68	Fastback, 1/4 extensions	S7MS-6327702/3	\$149.95 ^{PR}

SHELBY SIDE SCOOP



A quality reproduction of the Shelby Side Scoops. Ready to fit and paint.

Year	Part No.	List
65-66	S1MS-6529076/7	\$67.50 ^{PR}

FUNCTIONAL SIDE SCOOP



Available from Drake are these 1967-68 Mustang Lower Quarter Functional

Side Scoops. These are reproductions of early 1967 Shelby's that were functional for brake cooling. By mid-1967 Shelby stopped using this feature. Minor trimming to back sides of scoops on cooling tube is required if you do not want to make them fully functional.

Part No.	Year	List
S7MS-6529076/7	67-68	\$294.95 ^{PR}

NON-FUNCTIONAL SIDE SCOOP



Available from Drake are these 1967-68 Mustang Lower Quarter

Non-Functional Side Scoops. These are reproductions of the ones used on 1968 California Specials. Made from fiberglass, these are non-functional. For the fully functional versions order part # S7MS-6529076/7.

Year	Part No.	List
67-68	C8ZX-6529076/7	\$169.95 ^{PR}

CUSTOM FRONT SUPPORT BRACKET

This new restoration part from Scott Drake will help in building your very own Eleanor. The support brace bolts to factory bumper bracket holes. It serves two purposes by acting as a reinforcement for the lower nose, and as well as providing the mounting location for Eleanor Driving Lights. It is finished in a black textured powder coated surface. Get yours today to help make your dream car a reality.



Year	Part No.	List
67-68	S7MS-FSB	\$169.95 ^{EA}

WE PROUDLY FEATURE AUTHENTIC MUSTANG REPRODUCTIONS FROM SCOTT DRAKE!



FIBERGLASS BODY KIT

CUSTOM FIBERGLASS BODY KIT



Give you mustang a classic look! Not only do these cars look great, they are the hottest thing out there right now. The manufacturer went to great lengths to make sure this high quality kit was as easy to install as possible. We recommend that this kit be installed by an experienced fiberglass installer. Kit includes 18 parts. Hood, Nose, Headlamp buckets, wheel flares, side skirts, side scoops, tail panel, quarter extensions and deck lid. Also available, E2 Body Kits for 1965-66 Mustangs!

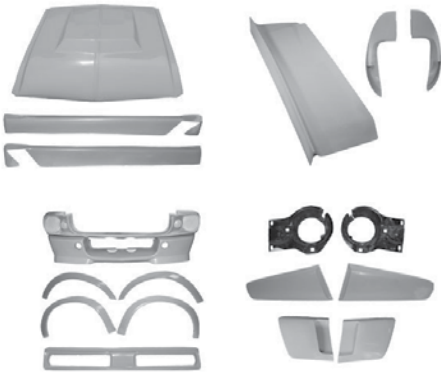

Year	Part No.	List
67-68	S7MS-E-FGMK	\$4,595. ⁰⁰ KT

STEERING

NEW STEERING GEAR BOX



These all new boxes feature a improved needle bearing design for smoother operation. They are a

direct bolt in, no modifications required. Early 67 have 1" sector shaft. Late 67 Ford switched to 1 1/8" sector shaft.

Year	Description	Part No.	List
64-67	16:1 ratio, power steering, long shaft	C5ZZ-3548-P	\$544. ⁹⁵ EA
67	16:1 ratio, short shaft 1" sector	C7ZZ-3548-P	\$599. ⁹⁵ EA
68-70	16:1 ratio, short shaft 1 1/8" sector	C8ZZ-3548-P	\$444. ⁹⁵ EA

STEERING GEAR BOX COVER SEAL



A leak coming from the steering box can sometimes be traced to the gasket at the steering box cover.

Part No.	List
C3DZ-3581-A	\$3. ⁹⁵ EA

STEERING BOX REBUILD KIT



This steering box rebuild kit can tighten up that loose, drifting feeling. Cover seal sold separately under part #C3DZ-3581-A.

Year	Description	Part No.	List
64-67	1"	C5ZZ-3548-RK	\$92. ⁹⁵ EA
67-70	1 1/8"	C7ZZ-3548-RK	\$92. ⁹⁵ KI

STEERING BOX FRAME BOLTS AND WASHERS

Concours correct for 1964-68 Mustangs. Will also fit 69-70 but not concours.



64-68: Bolts only
378331-S

List
\$8.²⁵ST



64-68: Washers only
378581-S

List
\$4.⁵⁰ST

STEERING COUPLER REBUILD KIT

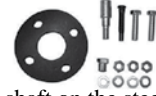

This steering coupler, commonly referred to as a "rag joint", connects the steering shaft to the input shaft on the steering box. **Look for a fully assembled steering coupler part #. C7OZ-3A525-A late 2015.**

Year	Description	Part No.	List
67-73	Polyurethane	C7OZ-3A525-P	\$28. ⁹⁵ SE
67-70	Rubber	C7OZ-3A525-R	\$19. ⁹⁵ EA

STEERING COUPLER ASSEMBLY



Save time and trouble with this affordable fully assembled steering coupler, versus trying to rebuild your original. Our coupler is very similar to the originals

in appearance especially when compared to the competitions. We use correct thickness Reinforced Rubber Isolator, stronger Rivets, Phosphate & Oil Coating, non-Metric Hardware and Locking Nuts all for safety and a more authentic appearance.

Year	Description	Part No.	List
67-73	Fully assembled	C7OZ-3A525-P	\$28. ⁹⁵ SE

STEERING COUPLER BOLT AND NUT



Concours correct. 2 required per car.

Year	Part No.	List
68-70	C8OZ-3A525	\$4. ⁹⁵ EA

STEERING CENTER LINK



Popular replacement item. Commonly bent or worn out.

Year	Description	Part No.	List
64-66	6 cyl., manual	C5ZZ-3304-EI	\$74. ⁹⁵ EA
64-66	V8, manual	C5ZZ-3304-CI	\$72. ⁹⁵ EA
65-66	V8, w/out ps control valve	C5ZZ-3304-DI	\$159. ⁹⁵ EA
67-69	6 and V8, manual	C7ZZ-3304-CI	\$89. ⁹⁵ EA
70	Manual	DOZZ-3304-CI	\$159. ⁹⁵ EA

PITMAN ARM



Forged arm replaces worn originals very nicely.

Year	Description	Part No.	List
64-66	V8, power steering	C5ZZ-3590-A	\$94. ⁹⁵ EA
67-70	V8, manual steering	C7ZZ-3590-B	\$92. ⁵⁰ EA

MANUAL STEERING ADAPTER



Simple economical way to convert power steering to manual.

Year	Description	Part No.	List
67-70	All	C7Z-3304-AD	\$167. ⁹⁵ EA

IDLER ARM



Forged iron replacement arms. Kits include bushings and hardware.

Year	Description	Part No.	List
64-66	6 cyl., manual steering	C3DZ-3352-L	\$74. ⁹⁵ EA
64-66	6 cyl., power steering	C4DZ-3352-B	\$162. ⁹⁵ EA
64-66	V8, manual or power steering	C5ZZ-3352-BR	\$62. ⁹⁵ EA
67-70	Power steering. One piece design	C7Z-3350-AR	\$79. ⁹⁵ EA
67-70	Power steering. Two piece design	C7Z-3350-CR	\$74. ⁹⁵ EA
67-70	Manual steering	C7Z-3350-BR	\$76. ⁹⁵ EA
71-73	Power steering	D1ZZ-3350-AR	\$74. ⁹⁵ EA

IDLER ARM BRACKET



Forged construction.

Year	Description	Part No.	List
64-66	260, 289	C3DZ-3351-A	\$44. ⁹⁵ EA

IDLER ARM BUSHING



These quality replacements are American made. Steel shell and tube. Fits original Ford idler arms only.

Year	Description	Part No.	List
64-66	Power steering	C3DZ-3356-AR	\$19. ⁹⁵ EA
64-66	Manual steering	C5ZZ-3356-AR	\$21. ⁹⁵ EA
67-70	Power steering, upper	C7OZ-3356-AR	\$19. ⁹⁵ EA

IDLER ARM MOUNT KIT



Concours correct mounting kit for 1964-68 Mustangs. Will also fit 1969-70 Mustangs but not concours.

Year	Part No.	List
64-68	378405-S	\$11. ⁹⁵ KT

INNER TIE ROD (USA)



Premium USA brands like Moog, TRW, or Federal Mogul. Very good quality at a fair price. See following page for Imported Tie Rods.

Part No.	Year	Description	List
C3DZ-3A131-AR	64-66	6 cyl., manual steering, RH or LH	\$31. ⁹⁵ EA
C4DZ-3A130-D	64-66	6 cyl., power steering, RH	\$95. ⁹⁵ EA

Part No.	Year	Description	List
C4DZ-3A131-C	64-66	6 cyl., power steering, LH	\$95. ⁹⁵ EA
CSZZ-3A131-CR	64-66	V8, power steering, LH	\$44. ⁹⁵ EA
CSZZ-3A131-DR	64-66	V8, manual steering RH or LH, power steering RH	\$41. ⁹⁵ EA
C7ZZ-3A131-AR	67-69	6 and V8, RH or LH	\$39. ⁹⁵ EA
DOZZ-3A131-AR	70	6 and V8, RH or LH	\$44. ⁹⁵ EA
D1ZZ-3A131-AR	71-73	6 and V8, RH or LH	\$57. ⁹⁵ EA

OUTER TIE ROD (USA)



Premium USA brands like Moog, TRW, or Federal Mogul. Very good quality at a fair price. See following page for Imported Tie Rods.

Year	Description	Part No.	List
64-66	6 cyl., manual steering, RH or LH	C3DZ-3A130-AR	\$34. ⁹⁵ EA
64-66	6 cyl., power steering, RH	C4DZ-3A130-C	\$99. ⁹⁵ EA
64-66	6 cyl., power steering, LH	C4DZ-3A131-D	\$99. ⁹⁵ EA
64-66	V8, power steering, LH	C5ZZ-3A130-CR	\$36. ⁹⁵ EA
64-66	V8, manual steering RH or LH, power steering RH	C5ZZ-3A130-DR	\$42. ⁹⁵ EA
64-66	V8, power steering, LH	CSZZ-3A130-SPEC	\$69. ⁹⁵ EA
67-69	6 and V8, RH or LH	C7ZZ-3A130-AR	\$31. ⁹⁵ EA
70-73	6 and V8, RH or LH	D1ZZ-3A130-AR	\$26. ⁹⁵ EA

TIE ROD END DUST SEAL



These aftermarket dust seals are more durable than the original rubber units, and will not blow out under grease pressure. Black only.

Part No.	Year	Description	List
9-13101	67-73	Polyurethane	\$6. ⁵⁰ PR
9-13103	64-67	Polyurethane	\$6. ⁵⁰ PR

INNER TIE ROD (IMPORTED)



These quality inner tie rods are imported, but have been and built to meet or exceed OEM specifications.

Year	Description	Part No.	List
64-66	6 cyl., man. steering, RH or LH	C3DZ-3A131-ARI	\$26. ⁹⁵ EA
64-66	V8, power steering, LH	C5ZZ-3A131-CRI	\$26. ⁹⁵ EA
64-66	V8, MS: RH or LH; PS: RH	C5ZZ-3A131-DRI	\$26. ⁹⁵ EA
67-69	6 / 8 cyl., RH or LH	C7ZZ-3A131-ARI	\$26. ⁹⁵ EA
70	6 / 8 cyl., RH or LH	DOZZ-3A131-ARI	\$29. ⁹⁵ EA
71-73	6 / 8 cyl., RH or LH	D1ZZ-3A131-ARI	\$29. ⁹⁵ EA

OUTER TIE ROD (IMPORTED)



These quality outer tie rods are imported, but have been designed and built to meet or exceed OEM specifications.

Year	Description	Part No.	List
64-66	6 cyl., manual steering, RH or LH	C3DZ-3A130-ARI	\$24. ⁹⁵ EA
64-66	V8, power steering, LH	C5ZZ-3A130-CRI	\$26. ⁹⁵ EA
64-66	V8, man steering RH or LH, power steering RH	C5ZZ-3A130-DRI	\$26. ⁹⁵ EA
67-69	6 and V8, RH or LH	C7ZZ-3A130-ARI	\$24. ⁹⁵ EA
70-73	6 and V8, RH or LH	D1ZZ-3A130-ARI	\$24. ⁹⁵ EA

TIE ROD ADJUSTING SLEEVE



Name brand quality.

Year	Description	Part No.	List
64-66	V8, power steering, LH Only	C2VY-3310-AR	\$34. ⁹⁵ EA
64-74	64-66: V8 67-73: 6/8 cyl, PS, LH or RH Made in USA	C2AA-3310-AR	\$12. ⁹⁹ EA
64-73	Import, 64-66: V8 67-73: 6/8 cyl, PS, LH or RH	C2AA-3310-ARI	\$8. ⁹⁵ EA
64-66	6 cyl., power steering	CSZZ-3310-AR	\$18. ⁹⁵ EA
64-66	6 cyl, manual	C3DZ-3310-ARI	\$14. ⁹⁵ EA

WE PROUDLY FEATURE AUTHENTIC MUSTANG REPRODUCTIONS FROM SCOTT DRAKE!



HOSES, PUMPS & CAPS

CONTROL VALVE TO CYLINDER HOSE



These are the short hoses Both are high pressure with correct fittings. These are not one size fits all like ones from the Auto

Parts store. Correct upper and lower hoses. Concours correct, Made by Drake!

Year	Desc.	Part No.	List
64-66	Set of 2	C3DZ-3A714/7-AR	\$42.95 ^{PR}
67-70	Set of 2	C6OZ-3A714/7-AR	\$42.95 ^{SE}

PRESSURE POWER STEERING HOSE



A power steering hose just has to fit, and you will find that our new concours correct hoses not only have the correct, pre-bent

ends, they have the "step down" size so they work just like the originals. We also offer aftermarket replacements for less popular applications.

Concours correct hoses from Scott Drake

Year	Description	Part No.	List
65-66	289, w/ Ford pump, Concours correct exact fit!	C5ZZ-3A719-D	\$36.95 ^{EA}
67	289, 1/4" control valve fitting, Concours correct exact fit!	C7OZ-3A719-C	\$36.95 ^{EA}
67-68	289, 302, 5/16" cv fitting Concours correct exact fit!	C7OZ-3A719-D	\$36.95 ^{EA}
67-70	All valve end, 5/16" fitting	C7ZZ-3A494-A	\$29.95 ^{EA}

Aftermarket replacement hoses

Year	Description	Part No.	List
64	200, w/ Ford pump	C5DZ-3A719-A	\$41.95 ^{EA}
64-65	260, 289, w/ Eaton pump	C5ZZ-3A719-E	\$40.95 ^{EA}
67	200, 1/4" control valve fitting	C7OZ-3A719-A	\$35.95 ^{EA}
67-70	390, 428, pump end	C7ZZ-3A719-B	\$28.95 ^{EA}
67-68	200, 250, 5/16" control valve fitting	C8OZ-3A719-B	\$33.95 ^{EA}
69	302, 351, pump end, w/ out cooler	C9ZZ-3A719-A	\$29.95 ^{EA}
69	302, pump end, w/ cooler	C9ZZ-3A719-C	\$30.95 ^{EA}
70	302, 351, pump end, w/ out cooler	D0OZ-3A719-E	\$28.95 ^{EA}
71-72	302, 351, before 5-1-72	D1ZZ-3A719-C	\$41.95 ^{EA}
71-73	302, 351, after 5-1-72	D1ZZ-3A719-A	\$28.95 ^{EA}

POWER STEERING HOSE SLEEVE



Exact reproduction of original. The 20" length is enough to do all cars. Cut to fit as different lengths were used on each model in

different locations. Oil resistant sponge rubber sleeve that fits all over the power steering hose to prevent damage from rubbing against other components. Original equipment on 69-71 Boss 302, 429 and 428 CJ and all Ford cars with a power steering cooler.

Year	Part No.	List
69-71	C9ZZ-3713-P	\$22.95 ^{EA}

RETURN POWER STEERING HOSE



Our 64-68 Small Block return hoses are exact copies of the original. We used Ford prints to assure a perfect fit.

Year	Description	Part No.	List
64-66	260, 289 Concours, Now by Drake!	C5DZ-3A713-D*	\$24.95 ^{EA}
67-70	200, 289, 302 Concours, Now by Drake!	C7OZ-3A713-A*	\$24.95 ^{EA}
67-70	67-70 BB & 69-70 SB	C7OZ-3A713-C	\$19.95 ^{EA}
71-73	250, 302, 351, w/ out air	D1ZZ-3A713-A	\$25.95 ^{EA}

POWER STEERING HOSE BRACKET



Die stamped metal construction. Insulators not included.

Year	Part No.	List
64-66	C5DZ-3A609/1-A	\$29.95 ^{EA}
67-68	C7DZ-3A609/1-A	\$29.95 ^{EA}

POWER STEERING HOSE

INSULATOR



Made from molded rubber that is specially blended to resist hardening and cracking.

Year	Part No.	List
64-66	C2OZ-3A609-A	\$6.95 ^{EA}
67-70	C7ZZ-3A609-A	\$6.95 ^{EA}

POWER STEERING PUMP CAP



Power steering canister/pump housing for Ford style pump. This canister has the neck angled back

to clear the A/C compressor and will fit non A/C cars also. Comes with a seal and needs to be painted. Will not fit w/ modern Sanden-style A/C conversions. Will clear OEM York compressors. Now available after being gone for years. Features exact details.

Year	Description	Part No.	List
64-65	Zinc, w/ dipstick, Eaton pump	C3AZ-3A006-A	\$12.95 ^{EA}
64-65	Chrome, w/ dipstick, Eaton pump	C3AZ-3A006-C	\$15.95
65-66	Chrome, concours, w/ out dipstick	C5AZ-3A006-BC	\$15.95 ^{EA}
65-66	Zinc, concours, w/ dipstick	C5AZ-3A006-C	\$12.95 ^{EA}
65-66	Chrome, concours, w/ dipstick	C5AZ-3A006-CC	\$15.95 ^{EA}

POWER STEERING PUMP DIPSTICK



Excellent reproductions with high level of detail. Both feature the FoMoCo logo.

Year	Description	Part No.	List
67-73	Zinc, concours	C7AZ-3A006-B*	\$13.95 ^{EA}
67-73	Chrome, concours	C7AZ-3A006-C*	\$15.95 ^{EA}

BILLET POWER STEERING PUMP CAP



Made by Scott Drake, these Billet Power Steering Pump Caps dress up your engine and look great with our other

Billet Engine Caps, See the "Engine" section of this catalog for matching engine caps.

Year	Description	Part No.	List
65-66	Power steering cap cover, w/out stick	B-3A006-A	\$29.95 ^{EA}
65-66	Power steering cap, w/ stick	B-3A006-B	\$29.95 ^{EA}
67-70	Power steering handle, w/ stick	B-3A006-C	\$32.95 ^{EA}

POWER STEERING PUMP MOUNTING BRACKET



65-66: 289, Ford pump
C5AZ-3A732-B

List

\$154.⁹⁵ EA

67-69: 289, 302, 351, 390, 428
C7ZZ-3A732-B

List

\$79.⁹⁵ EA

POWER STEERING PUMP SEAL KIT

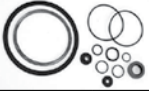

Provides everything needed to do a pump rebuild.

Year	Description	Part No.	List
64-65	Eaton pump	C2AZ-3B584-AR	\$15. ⁹⁵ KI
65-73	Ford pump	D1AZ-3B584-A	\$9. ⁹⁵ KI

POWER STEERING PUMP ADJUSTER BRACKET



Used in conjunction with C7ZZ-3A732-B Bracket.

Year	Description	Part No.	List
67-69	289, 302	C7SZ-3A732-A	\$64. ⁹⁵ EA

POWER STEERING MOUNT BOLT



Concours correct for 1967-69 Mustangs.

Year	Part No.	List
67-69	377060-5	\$5. ⁷⁵ EA

POWER STEERING AND RACK & PINION KITS

POWER STEERING CONVERSION KIT

The conversion box is a remanufactured modern integral power steering gearbox. It provides true modern power steering feel, feedback and sporty 16:1 ratio. It has been remanufactured to bolt directly to the factory mounting location and to fit the stock pitman arm without any interference or modification of the shock tower. 1965-67 Mustangs will require replacing column shaft. 68-70 Mustangs will need the factory column collapsed 1-2" for clearance. Eliminate your leaky control valve and sloppy steering. Feel the road with our new integral power steering conversion kits. We offer both Kits to convert from MS to PS and Factory PS to PS. Please note Factory Ford Pumps work fine with these Kits above Idle but will offer very little power assist under 800 RPM's. We can special order a PS to PS Kit with a modern Saginaw Pump that is more effective at Lower RPM's.

Note: Manual Transmission cars must run a special Clutch Equalizer Bar or a Clutch Cable Set-Up, both are available in the Transmission section (Big Block Equalizer not available at this time). Due to the fact that there are 8 possible kits for 1967, some will cross-over to listed kits, and others are available as special order, so please call. Early 1967 Cars with the Long Shaft that are converting from PS to PS will be required to also purchase a C7ZZ-3304-AD Adapter. 6-cylinder kits available as Special Order.

Year	Description	Part No.	List
64-66	V8 Early 67: 289 w/ long shaft & shaft 1" sector Manual Steering to Power Steering	C5ZZ-MS-PS-CK	\$1,089. ⁹⁵ KT



Year	Description	Part No.	List
64-66	Power Steering to Power Steerin	C5ZZ-PS-PS-CK	\$904. ⁹⁵ KT



Year	Description	Part No.	List
67	Late 67*: Small Block 68-70: 289, 302, 351W Manual Steering to Power Steering	C8ZZ-MS-PS-CK	\$999. ⁹⁵ KT



Year	Description	Part No.	List
67	Late 67*: Small Block 68-70: 289, 302, 351W Late 67-70: Big Block w/ Automatic Power Steering to Power Steering	C8ZZ-PS-PS-CK	\$864. ⁹⁵ KT



FLAMING RIVER RACK & PINION KIT



Manual steering that feels like power steering. Easy installation that maintains the original suspension. No welding.

No fabrication. Due to many variations, we recommend contacting us with your specific application to assure the correct kit. Tilt columns for original steering wheel are available as a special order. Power Steering Kit available as a special order.



Year	Description	Part No.	List
64-69	Rack and pinion, stock spindles, stock exhaust manifolds, no tilt column. Modify factory column.	C5ZZ-3304-RPSM	\$1,054. ⁹⁵ KT
64-69	Rack & pinion, Granada spindles, stock exhaust manifolds, w/ paintable tilt column. Aftermrkt wheel.	C5ZZ-3304-RPK	\$1,399. ⁹⁵ KI
64-70	Small block, w/ headers, no tilt column. Modify factory column.	C5ZZ-3304-RPSH	\$1,599. ⁹⁵ EA
64-69	SB, w/ headers, w/ paintable tilt column. After-market wheel.	C5ZZ-3304-RPSHK	\$1,775. ⁰⁰ EA

FLAMING RIVER TILT STEERING COLUMN



Available in paintable steel or polished stainless steel. Requires mounting kit. Will fit 1970 cars but relocation of ignition switch is required. These fit original steering boxes only. Modifications required to 64-67E shaft. Original versions have original Ford splines to accept factory wheels. The below Tilt Steering Columns are for use with factory steering boxes only and are not to be used with rack & pinion kits. Rack & pinion kits are available as a Special Order, add "-RP" to the end of the appropriate part number below. Prices are the same provided it can be added to our next stocking order, otherwise additional freight charges will apply.



Year	Description	Part No.	List
65-66	For Grant wheels only	C5ZZ-3514-AFT	\$329 ⁹⁵ EA
65-66	For Grant wheel, Stainless	C5ZZ-3514-AFT-S	\$699 ⁹⁵ EA
65-66	For original wheel	C5ZZ-3514-OEM	\$414 ⁹⁵ EA
Late 67-69	For Grant wheels only	C7ZZ-3514-AFT	\$329 ⁹⁵ EA
Late 67-69	For Grant wheel, Stainless	C7ZZ-3514-AFT-S	\$629 ⁹⁵ EA
Late 67-69	For original wheel	C7ZZ-3514-OEM	\$414 ⁹⁵ EA

FLAMING RIVER TILT STEERING COLUMN MOUNT KIT



This kit includes all components to install a Flaming River tilt column.

Year	Part No.	List
65- early 67	C5ZZ-3514-MK	\$129 ⁹⁵ EA
Late 67-70	C7ZZ-3514-MK	\$129 ⁹⁵ EA

IDIDIT TILT STEERING COLUMN MOUNT KIT



These kits include the components needed to install your ididit Tilt Steering Column. Use with stock steering boxes only. Will not fit Rack & Pinion kits.

Year	Part No.	List
65- early 67	C5ZZ-3514-IK	\$59 ⁹⁵ EA
Late 67- 68	C7ZZ-3514-IK	\$199 ⁹⁵ EA
69	C9ZZ-3514-IK	\$134 ⁹⁵ EA

POWER STEERING CONTROL VALVE



Brand new, no core required.

Year	Description	Part No.	List
64-66	V8	C5ZZ-3A730-N	\$599 ⁹⁵ EA
67-70	5/16" Port	C8ZZ-3A730-SS	\$319 ⁹⁵ EA

POWER STEERING CONTROL VALVE SEAL KIT



Includes all seals, gaskets and "O" rings needed to stop leaks. Makes your control valve perform properly.

Part No.	Year	List
C3AZ-3A650-A	64-70	\$19 ⁹⁵ KI

IDIDIT TILT STEERING COLUMN



ididit introduces the first Ford Top Shaft and Ford Turn Signal Switch tilt steering column for 1965-69 Mustangs! This made

to fit column will include a special new floor mount, 8-position tilt. Mustang style knobs & handles and male & female plugs with terminals. ididit's new Mustang column will accept a stock Mustang steering wheel or an aftermarket wheel with an adaptor. By using the stock underdash mount and a coupler (sold separately), the installation is a breeze! The new 8-position tilt 1965-69 Mustang column is available in Paintable Steel, Chrome and Black Powder Coated. Lower shaft is 3/4" 36. Don't forget your installation kit, each installation kit from ididit is specific to your Mustang application. Each ididit column is 100% American Made. Note: 65-67E require cutting original shaft. The below part numbers are for use with stock steering boxes. For Rack and Pinion add "-RP" which are available as a Special Order for \$25 more.

Year	Description	Part No.	List
65-66	Paintable steel	C5ZZ-3514-S	\$549 ⁹⁵ EA
65-66	Black	C5ZZ-3514-B	\$699 ⁹⁵ EA
65-66	Chrome	C5ZZ-3514-C	\$624 ⁹⁵ EA
67	Paintable steel	C7ZZ-3514-S	\$499 ⁹⁵ EA
67	Black	C7ZZ-3514-B	\$599 ⁹⁵ EA
67	Chrome	C7ZZ-3514-C	\$649 ⁹⁵ EA
68-69	Paintable steel	C8ZZ-3514-S	\$609 ⁹⁵ EA
68-69	Black	C8ZZ-3514-B	\$749 ⁹⁵ EA
68-69	Chrome	C8ZZ-3514-C	\$724 ⁹⁵ EA

POWER STEERING BALL & STUD REPAIR KIT



Includes ball and stud kit and all seals necessary to stop leaks and reduce excess play in steering wheel.

Year	Part No.	List
64-70	C2AZ-3A533-A	\$52 ⁹⁵ KI

POWER STEERING SOCKET SLEEVE



This bronze/steel sleeve should be replaced to do a proper rebuild on your control valve.

Part No.	Year	List
C1AA-3A754-C	65-70	\$22 ⁹⁵ EA

POWER STEERING FRAME RAIL COMPRESSION NUTS

These compression nuts are needed when installing power steering into manual steering cars. Installation Kit, 375474-IK required for proper install.



375474-IK
64-70: Installation Kit

List
\$8⁹⁵ KT

375474-SK
64-70: Pair of compression nuts

List
\$4⁹⁵ PR

POWER STEERING CYLINDER BOOT & CLAMP



Compression molded rubber grease and corrosion resistant. Special locking metal band that fits around power steering ram boot.

Year	Part No.	List
64-70	C5ZZ-3A540-B	\$9 ⁹⁵ EA

POWER STEERING RAM CYLINDER



These are brand new steering cylinders. No core is necessary on these.

Part No.	Year	List
C3DZ-3A540-A	67-70	\$134 ⁹⁵ EA
C3DZ-3A540-B	64-66	\$134 ⁹⁵ EA

POWER STEERING CYLINDER BOOT

KIT



Our boot kit includes exact OE washers, steel tube spacer and high quality EPDM rubber bushings and boot.

Year	Part No.	List
64-70	C60Z-3C651-A	\$14. ⁹⁵ KI

POWER STEERING CYLINDER SEAL

KIT



Kit includes all repair parts necessary to refurbish leaking cylinder/piston rod seal area.

Year	Part No.	List
64-70	C1AZ-3A764-A	\$21. ⁹⁵ KI

POWER STEERING DROP BRACKET

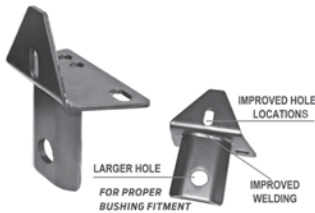

A must when using full length headers, including Tri-Y's, on a power steering car. Lowers power steering for proper clearance when using Tri-Y headers. Now made by Drake, this part features thicker metal and better welds! Now with correct hole size for bushing!

Year	Part No.	List
64-70	DBPP-10961-A	\$22. ⁹⁵ EA

POWER STEERING TO FRAME BUSHING



Improves steering response. Made from polyurethane, these bushings are long lasting and firmer than stock.

Year	Part No.	List
64-66	C5ZZ-3A344-P	\$20. ⁹⁵ PR
67-70	C7ZZ-3A344-P	\$23. ⁹⁵ PR

LOWER STEERING COLUMN COVER

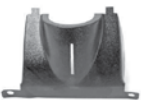

A very nice reproduction of a commonly broken part.

Year	Part No.	List
69	C9ZZ-6504459-BK	\$44. ⁹⁵ EA
70	D0ZZ-6504459-BK	\$44. ⁹⁵ EA
71-73	D1ZZ-6504459	\$32. ⁹⁵ EA

STEERING COLUMN TO FIREWALL SEAL



These high quality parts assure the restorer of an air-tight seal where the steering column passes through the firewall.

Year	Description	Part No.	List
64-66		C5ZZ-3513	\$3. ⁰⁰ EA
67-68		C7ZZ-3513	\$3. ⁰⁰ EA
69-70		C9ZZ-3513	\$15. ⁹⁵ EA
71-73	Manual Trans	D1ZZ-3513-A	\$24. ⁹⁵ EA

STEERING COLUMN TO FLOOR GROMMET



Molded rubber. Mounts on steering column over carpet.

Year	Part No.	List
65-67	B5S-3512	\$8. ⁹⁵ EA

STEERING COLUMN TO GEAR BOX INSULATOR



Year	Part No.	List
64-67	C60Z-3564	\$9. ⁹⁵ EA

STEERING SHAFT SPRING



This is the spring that goes over the shaft and inside the collar to provide spring tension on the bushing to keep the shaft centered in the column.

Year	Part No.	List
64-67	C3DZ-3520-A	\$6. ⁵⁰ EA

STEERING COLUMN BUSHING



Scott Drake used the actual Ford print of Fords improved service replacement part to replicate this bushing. Now made of nylon for a better fit and longer, quieter life. This is the perfect replacement for the original metal bushing.

Year	Part No.	List
64-67	B1AZ-3518-A	\$9. ⁹⁵ EA

STEERING COLUMN UPPER BEARING



Previously obsolete bearing. Eliminate the grinding and squeaking commonly associated with a 50 year old bearing especially if exposed to moisture.

Year	Part No.	List
64-66	C3DZ-3517-A	\$11. ⁹⁵ EA

STEERING COLUMN UPPER BEARING SLEEVE



Rubber sleeve bearing snaps into.

Year	Description	Part No.	List
68-73	w/o Tilt	C8AZ-3518-A	\$5. ⁹⁵ EA

STEERING WHEEL NUT



This really is the nut behind the steering wheel.

Year	Part No.	List
64-67	350983-S	\$2. ⁹⁵ EA

STEERING

STANDARD MUSTANG STEERING WHEELS



A new steering wheel can bring your entire interior together. Replace your cracked and faded originals

Year	Description	Part No.	List
64	Black, generator	C4ZZ-3600-BK	\$174. ⁹⁵ EA
64	Blue, generator	C4ZZ-3600-BL	\$174. ⁹⁵ EA
64	Red, generator	C4ZZ-3600-RD	\$174. ⁹⁵ EA
64	White, generator	C4ZZ-3600-WT	\$174. ⁹⁵ EA
65-66	Black	C5ZZ-3600-BK	\$164. ⁹⁵ EA
65	Blue	C5ZZ-3600-BL	\$164. ⁹⁵ EA
65	Bright red	C5ZZ-3600-BR	\$164. ⁹⁵ EA
65	Palamino	C5ZZ-3600-PA	\$164. ⁹⁵ EA
65-66	White	C5ZZ-3600-WT	\$164. ⁹⁵ EA
66	Aqua	C6ZZ-3600-AQ	\$164. ⁹⁵ EA
66	Dark red	C6ZZ-3600-DR	\$164. ⁹⁵ EA
66	Light blue	C6ZZ-3600-LB	\$164. ⁹⁵ EA
66	Parchment	C6ZZ-3600-PR	\$164. ⁹⁵ EA
67	Black	C7ZZ-3600-BK	\$174. ⁹⁵ EA
67	Blue	C7ZZ-3600-BL	\$174. ⁹⁵ EA
67	Dark red	C7ZZ-3600-DR	\$174. ⁹⁵ EA
67	Ivy Gold	C7ZZ-3600-IG	\$174. ⁹⁵ EA
67	Light Parchment	C7ZZ-3600-PR	\$174. ⁹⁵ EA
68-69	Black 2 spoke	C8ZZ-3600-BK	\$199. ⁹⁵ EA

Steering

WE PROUDLY FEATURE AUTHENTIC MUSTANG REPRODUCTIONS FROM SCOTT DRAKE!



MUSTANG HORN RING BUTTON



Excellent concours reproduction made by Scott Drake. Diecast construction features acrylic plastic center emblem, chrome plated main assembly and painted recesses. 1964-66 fully assembled and ready to install. Horn Spring not included.



Year	Part No.	List
65-66	C5ZZ-13A805-B	\$104. ⁹⁵ EA
64	C5ZZ-13A805-C	\$104. ⁹⁵ EA

HORN RING BUTTON



65-67: Deluxe, for wood wheel, no emblem, 3 spoke
C70Z-13A805-ER

List
\$56.⁹⁵ EA



67: Standard, no emblem, 3 spoke
C7ZZ-13A805-A

List
\$89.⁹⁵ EA



68-69: Standard, no emblem, 2 spoke Satin
C9AZ-13A805-B

List
\$64.⁹⁵ EA

HORN RING CENTER PAD



Soft padded urethane. Not painted but molded urethane so color will not wear off. Features our chrome trim ring and center emblem.



Year	Description	Part No.	List
67	Black	C7ZZ-3623-BK	\$84. ⁹⁵ EA
67	Aqua	C7ZZ-3623-AQ	\$84. ⁹⁵ EA
67	Blue	C7ZZ-3623-BL	\$84. ⁹⁵ EA
67	Ivy Gold	C7ZZ-3623-IG	\$84. ⁹⁵ EA
67	Parchment	C7ZZ-3623-PR	\$84. ⁹⁵ EA
67	Red	C7ZZ-3623-RD	\$84. ⁹⁵ EA
67	Saddle	C7ZZ-3623-SA	\$84. ⁹⁵ EA

STEERING WHEEL EMBLEM

The most authentic and best looking emblems available.



67: Running horse
C7ZZ-3649-A



List
\$24.⁹⁵ EA



68: Running horse
C8ZZ-3649-AR



List
\$29.⁹⁵ EA



69-70: Shelby Cobra
C9MS-3649-A



List
\$22.⁹⁵ EA



69-73: For use on 2-spoke wheel
C9ZZ-3649-S



List
\$18.⁹⁵ EA

DELUXE 3-SPOKE STEERING WHEEL EMBLEM



Features ABS injection with a crystal clear lense, and a highly detailed Mustang logo. This is the center emblem for 3-spoke style.



Year	Description	Part No.	List
69	For 1969 3-spoke style steering wheel	C9ZZ-3649-B	\$21. ⁹⁵ EA
70-73	Deluxe emblem	D0ZZ-3649	\$23. ⁹⁵ EA

HORN PANEL BEZEL KIT



Everything you need including the plastic injection and chrome plated bezel; horn panel pad; Mustang tri-bar logo horn button; and horn panel bezel buttons.



Year	Part No.	List
68-69	C8ZZ-3D572-KIT	\$104. ⁹⁵ EA

HORN PANEL BEZEL



Plastic injection and chrome plated. Fits in center of steering wheel, holds vinyl pad and buttons.

Year	Part No.	List
68-69	C8ZZ-3D572-AR	\$21. ⁹⁵ EA

HORN PANEL BEZEL BUTTONS

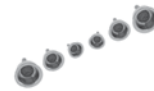

Chromed Plastic buttons with textured black centers. Set of 6. Standard interior only.

Year	Description	Part No.	List
68-69	Set of 6	C8ZZ-3600-AR	\$28. ⁹⁵ SE

STEERING WHEEL HUB TRIM



This is the chrome trim ring that goes on the steering wheel hub. 4 3/8" diameter. Installation note: warm up foam hub with hot air, apply solution of dish washing soap & water, then press firmly. Start at one end pressing firmly while rotating (like a bicycle tire).

Year	Part No.	List
67	C7ZZ-3656-A	\$11. ⁹⁵ EA

STEERING WHEEL HUB AND EMBLEM TRIM



Great kit for complete steering wheel restoration.



Year	Part No.	List
67	C7ZZ-3649/56-K	\$32. ⁹⁵ KI

HORN PANEL PAD



Year	Description	Part No.	List
68	Black, standard interior	C8AZ-3629-BK	\$21. ⁹⁵ EA
68	Parchment, standard interior	C8AZ-3629-N	\$21. ⁹⁵ EA



Year	Description	Part No.	List
69	Black deluxe 3 spoke	C9ZZ-3623	\$84. ⁹⁵ EA
70-73	Black deluxe 3 spoke	D0ZZ-3623-A	\$149. ⁹⁵ EA



Year	Description	Part No.	List
70-73	Black standard	D0ZZ-13915	\$84. ⁹⁵ EA

RIM BLOW HORN PAD COVER



Complete assembly (21 pcs) that installs over the top of the horn pad. Emblem sold separately.

Year	Part No.	List
69	C9ZZ-3752	\$119.95 ^{EA}

DELUXE STEERING WHEEL ASSEMBLY



Reproduction of Pony interior simulated wood wheel. Includes horn ring, contact plates and hardware. This wheel was also optional on standard interior cars. Horn center cap sold separately. We also offer the wheel separately for those who wish to re-use their horn ring, etc...

Year	Description	Part No.	List
65-66	Woodgrain, Assembly	CSZZ-3600-NK*	\$374.95 ^{SET}
65-66	Woodgrain, wheel only	CSZZ-3600-N	\$219.95 ^{EA}
67	Woodgrain, Assembly	C70Z-3600-NK	\$379.95 ^{SET}
69	Woodgrain, Rim blow steering wheel	C9AZ-3600-BK	\$659.95 ^{EA}

* Also correct for 1966 Shelby

STEERING WHEEL CENTER

Deluxe wheel only. Pressure die cast with quality chrome plating. Includes lens, rim, spring steel snap ring.

65-66: Concoors, Made in the USA
CSZZ-3623-A



List
\$99.95^{EA}

65-66: Economy, Import
CSZZ-3623-AR

List
\$58.95^{EA}

66: Shelby, Made in the USA
S2MS-3623-A



List
\$99.95^{EA}

DELUXE STEERING WHEEL UPPER COLLAR



Year	Description	Part No.	List
67	Deluxe	C70Z-3656-A	\$39.95 ^{EA}

DELUXE STEERING WHEEL COLLAR



Mounts on bottom of original deluxe wheel. Die cast construction like original. Concoors plating.

Year	Part No.	List
65-66	CSZZ-3491-A	\$45.95 ^{EA}
67	C70Z-3491-A	\$64.95 ^{EA}

HORN LENS INSULATOR



This foam pad goes between the lens and body of the center cap on the deluxe steering wheel.

Year	Description	Part No.	List
65-66	Deluxe	CSZZ-13A816-A	\$2.95 ^{EA}

STEERING WHEEL INSULATOR HARDWARE KIT



15 piece kit.

Part No.	Year	Description	List
CSZZ-13A890/1MK	65-67	Deluxe	\$19.95 ^{KT}

STEERING WHEEL INSULATOR KIT



Plastic injection, exact copies of these hard to find originals. Fits on both horn contact rings. Insulates mounting screws from contact rings. Pony interiors and deluxe wood wheels only.

Year	Part No.	List
65-67	CSZZ-13A890/1-A	\$14.95 ^{KI}

STEERING WHEEL HORN CONTACT PLATE



Deluxe Wood Wheel Horn Contact Plate.

Year	Part No.	List
65-66	CSZZ-13A808/9	\$69.95 ^{PR}

HORN CONTACT INSULATOR



Replace that broken insulator with this new part.

Year	Description	Part No.	List
67	Excluding wood wheels	C7AZ-13A903-B	\$3.50 ^{EA}

HORN RING CONTACT KIT



Exact reproduction horn ring contact components for the standard horn button.

Year	Part No.	List
65-66	CSZZ-13A821	\$10.95 ^{KI}
67	C7AZ-13A821	\$18.95 ^{KI}
68-69	C8AZ-13A821	\$19.95 ^{KI}

HORN RING RETAINER



Correct original design. Plastic injected nylon is more wear and crack resistant. Standard wheels only.

Year	Desc	Part No.	List
64	Generator	C2DZ-13A809-A	\$2.00 ^{EA}
65-66	Alternator	D1TZ-13A809-A	\$1.95 ^{EA}

HORN BUTTON RUBBER SPRING PAD



This is the oe rubber pad that is typically smashed in the horn button. Standard wheels only.

Year	Part No.	List
64-67	CODZ-13A813-A	\$2.95 ^{EA}

HORN BUTTON SPRING



Wire spring used with horn ring. Painted. Not used on 65-67 deluxe wood wheel or 69 rim blow wheel.

Year	Part No.	List
65-69	CODZ-13A807-B	\$4.95 ^{EA}

Steering

WE PROUDLY FEATURE AUTHENTIC MUSTANG REPRODUCTIONS FROM SCOTT DRAKE!



RIM BLOW HORN SWITCH



The switch that goes inside the rim of the steering wheel to actuate the horn.

Year	Description	Part No.	List
69	Switch	C9AZ-13A875-C	\$134. ⁹⁵ EA
70-73	Switch	D1AZ-13A875-A	\$119. ⁹⁵ EA

HORN SWITCH



Part No.	Year	List
D2AZ-13875	70-73	\$98. ⁹⁵ EA

HORN SWITCH TRIM PLATE



Wood grain plate for deluxe 2 spoke wheel.

Year	Description	Part No.	List
71-73	Wood grain	D1ZZ-13932	\$40. ⁹⁵ EA

HORN CONTACT SPRING



2 required per car.

Year	Description	Part No.	List
64	Original style	C2OZ-13A821-A	\$7. ⁹⁵ EA

TILT AWAY STEERING VACUUM CANISTER



Mounts to rear passenger side fender apron. Hold vacuum pressure to operate tilt away switch when car is turned off.

Year	Description	Part No.	List
67-69	1 port	C7ZZ-3E547-A	\$94. ⁹⁵ EA
67-69	2 ports	C7ZZ-3E547-B	\$99. ⁹⁵ EA

GRANT STEERING WHEEL



Aluminum frame aftermarket steering wheel with Mustang center emblem on horn center. Choose from real wood or black foam. Adapter required.



Year	Description	Part No.	List
64-73	Wood, 15"	966	\$184. ⁹⁵ EA
65-73	Black foam, 15"	968	\$134. ⁹⁵ EA
65-73	Wood, 13-1/2"	963	\$179. ⁹⁵ EA



Signature series also available. Features include: genuine mahogany grips, polished aluminum spokes, machined billet trim rings, horn button

and hub cover. Requires either hub or adapter kit for installation.

Year	Description	Part No.	List
65-73	Grant signature series, 15"	1170	\$249. ⁹⁵ EA
65-73	Grant signature series, 15" With simulated rivets	1175	\$309. ⁹⁵ EA

GRANT STEERING WHEEL ADAPTER



Mounting and contact adapter required for each Grant wheel. **Note: Do not use with Flaming River aftermarket columns.**

Year	Description	Part No.	List
68-73		3249	\$26. ⁹⁵ EA
64		3285	\$26. ⁹⁵ EA
65-70	Flaming River	CSZZ-3514-GMA	\$26. ⁹⁵ KIT

GRANT HUB KIT

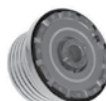

These kits are fully assembled for easy installation and are available in either a highly polished mirror finish or anodized in deep, black luster finish. Year 1170 and 1175 wheels only.

Part No.	Year	Description	List
5249	68-73	Black	\$71. ⁹⁵ EA
5249-1	68-73	Highly polished, Alum	\$71. ⁹⁵ EA

GRANT HORN BUTTON

Optional button to customize your Grant steering wheel.



64-73: Grant 966, 968 and 963 wheels 5847



List
\$34.⁹⁵ EA



64-73: Chrome, fits 1170 and 1175 5875



List
\$44.⁹⁵ EA



65-73: Ford blue, fits 1170 and 1175 5665



List
\$24.⁹⁵ EA



64-73: Horn button, 0 fits 1170 and 1175 5668



List
\$24.⁹⁵ EA

CORSO FEROCCE SHELBY STEERING WHEEL



This new Corso Feroce steering wheel is a stunning replica of the wood rimmed steering wheel originally equipped on the 1967 Shelby GT350 and GT500s. It features a beautifully finished real solid wood with proper finger indents on the back and a black band around the bottom surface just like the originals. The sporty 3 spoke design is brushed stainless steel with 4 chamfered holes per spoke and unique black rubber finger guards. The main center hub is CNC machined aluminum with a satin finish. Concours correct GT350 and GT500 horn button assemblies are available. We also have a Mustang Horn Button option as well. Each wheel comes equipped with a 65-67 mounting hub. 68-73 Adapter Kit coming soon.

Year	Description	Part No.	List
65-67	Shelby GT500	S7MS-3600-A	\$349. ⁹⁵ EA

CORSO FEROCCE STEERING WHEEL 9 HOLE



This beautiful Corso Feroce Steering Wheel was handcrafted with pride. Featuring polished aluminum spokes. This black leather wheel has been hand stitched onto a fully padded rim for a truly luxurious feeling. Column Adapter, Mustang or Cobra Emblem are sold separately.



Year	Description	Part No.	List
65-73	Leather, 15" 9 Hole	S1MS-3600-BK	\$149. ⁹⁵ EA



Scott Drake's beautiful Corso Feroce Steering Wheels are the perfect choice for that Classic Cobra, Mustang, or Shelby look. Featuring polished aluminum spokes and made from hand rubbed marine mahogany, Includes stainless steel mounting screws and polished retaining ring for installation. Column Adapter, Horn Button and Mustang or Cobra Emblems are sold separately.

Year	Description	Part No.	List
65-73	Genuine wood, 14" 9 Hole	S1MS-3600-WG-14	\$149. ⁹⁵ EA
65-73	Genuine wood, 15" 9 Hole	S1MS-3600-WG	\$209. ⁹⁵ EA

CORSO FEROCCE STEERING WHEEL 6 HOLE



This black leather steering wheel by Corso Feroce closely resembles an original 1965 GT350 Steering Wheel. The Corso Feroce wheel features a functional horn button unlike the original. Column Adapter, Horn Button and Emblems sold separately.

Year	Description	Part No.	List
65-73	Black leather, 15" 6 Hole	S1MS-3600-BK-6	\$159. ⁹⁵ EA



Scott Drakes, beautiful Corso Feroce Steering Wheels are the perfect choice for that clean factory look as seen on original 1965 GT350 Shelby's. Although ours closely resembles the original, we made one big improvement in the fact that ours accepts our functional Horn Button (sold separately). This wheel also features polished aluminum spokes and made from hand rubbed marine mahogany, these 15" diameter wood wheels are handcrafted with pride. Column Adapter, Horn Button and Mustang or Cobra Emblems are sold separately.

Year	Description	Part No.	List
65-73	Genuine wood, 14" 6 Hole	S1MS-3600-WG146	\$219. ⁹⁵ EA
65-73	Genuine wood, 15" 6 Hole	S1MS-3600-WG-6	\$219. ⁹⁵ EA

CORSO FEROCCE COLUMN ADAPTER 9 HOLE



Hub to adapt the Corso Feroce steering wheels. Now with adjustable collar. Required to mount Corso Feroce wheel.

Year	Description	Part No.	List
65-66	Billet, 9 hole	S1MS-3511-P	\$84. ⁹⁵ EA
68-73	Billet, 9 hole	S7MS-3511-P	\$84. ⁹⁵ EA

CORSO FEROCCE COLUMN ADAPTER 6 HOLE



Hub to adapt the Corso Feroce steering wheels. Now with adjustable collar. Required to mount Corso Feroce wheel.

Year	Description	Part No.	List
65-67	Billet, 6 hole	S1MS-3511-P-6	\$89. ⁹⁵ EA
68-73	Billet, 6 hole	S8MS-3511-P-6	\$89. ⁹⁵ EA

CORSO FEROCCE SHELBY HORN BUTTON



This concours quality reproduction is made just like the originals on the 1967 Shelby's. Features Stamped Steel Show Quality Chrome plated Bezel

with Vacuum Metalized Acrylic lens with raised Aluminum Emblem. Choose from an authentic GT350 or GT500 versions or our Classic Tri-Bar Running Horse Emblem. Fully functional Horn Button assembly compatible with original Shelby Wheels or our S7MS-3600-A Corso Feroce Wheel.



Year	Description	Part No.	List
65-73	Shelby GT500 horn button	S7MS-3623-GT500	\$199. ⁹⁵ EA
65-73	Shelby GT350 horn button	S7MS-3623-GT350	\$199. ⁹⁵ EA
65-73	Mustang horn button	S7MS-3623-MG	\$149. ⁹⁵ EA

CORSO FEROCCE HORN BUTTON 9 HOLE



This horn button assembly features chrome plated plastic injected center cap with clear acrylic domed lens house. 1 of 2 optional emblems. **Emblems sold separately.**



Year	Description	Part No.	List
65-73	9 Hole	S1MS-3623-A	\$15. ⁹⁵ EA

Steering

**WE PROUDLY FEATURE AUTHENTIC MUSTANG
REPRODUCTIONS FROM SCOTT DRAKE!**



CORSO FEROCO HORN BUTTON 6 HOLE



This horn button assembly features chrome plated plastic injected center cap with clear acrylic domed lens. Houses 1 of 2 optional emblems. **Emblems sold separately.**

Year	Description	Part No.	List
65-73	6 Hole	S1MS-3623-A-6	\$21. ⁹⁵ EA

COBRA HORN BUTTON EMBLEM 6 HOLE



This horn button assembly features chrome plated plastic injected center cap with clear acrylic domed

lens made especially for our 6 hole Corso Feroce steering wheel. The center houses our beautifully detailed Cobra emblem.



Year	Description	Part No.	List
65-73	6 Hole	S1MS-3623-COBRA	\$39. ⁹⁵ EA

HORN BUTTON EMBLEMS

This fits the horn button to change center emblem to Cobra or Mustang. Fits both 6 and 9 hole wheels. **See Key Fobs in "Accessories" section for other available emblems.**



65-73: Cobra
S1MS-3649-C



List
\$13.⁹⁵ EA



65-73: Mustang,
Plastic injection,
Back painted
3D emblem
C7ZZ-65044A90-M



List
\$19.⁹⁵ EA

SUSPENSION

PROGRESSIVE RATE COIL SPRINGS



These springs allow your Classic Mustang to take advantage of the latest suspension technology and perform more

like a modern sports car. They really do give you the best of both worlds. A fairly stock smooth ride during normal driving, but as the springs compress under load (primarily during braking and cornering) they progressively become firmer very quickly to offer the handling characteristics similar to our 600 pound performance springs, but without sacrificing ride comfort. These progressive rate springs are suitable for long pleasant family road trips as well as a variety of autocross and race courses. These are a little more money, but well worth it if you are looking for the best money can buy. Made exclusively for us in the USA by a premier OEM supplier (for strictly race car applications we still recommend our Performance Springs). Our Progressive Rate Coil Springs feature: Hot wind from SAE5160H, oil quench, temper, water quench, shot peen, preset, 100% load test, ground flat and black powder coating. These springs will sit your vehicle slightly lower than our Stock Coil Springs, actual drop will vary with overall car weight. These are not lowering springs. Springs can be trimmed if necessary. We do not recommend big block springs on small block cars.

Year	Description	Part No.	List
64-66	V8 400-550 #	C5ZZ-5310-PR	\$169. ⁹⁵ PR
67-70	289,302,351, 400-525 #	C7ZZ-5310-SB-PR	\$174. ⁹⁵ PR
67-73	67-70: 390, 428 71-73: 351C 460-600 #	C7ZZ-5310-BB-PR	\$179. ⁹⁵ PR

PERFORMANCE COIL SPRING



These springs are custom wound for the performance oriented customer. They feature 600-pound/inch rating and will lower the car approximately one inch from original stock height. Made in the USA exclusively for Scott Drake. Features black powder coating.

Year	Description	Part No.	List
64-66	High performance	C5ZZ-5310-P	\$89. ⁹⁵ PR
67-73	High performance	C7ZZ-5310-P	\$89. ⁹⁵ PR

GT COIL SPRING



These springs were original equipment on 1965 - 1966 GT Mustangs. Firmer than stock but offer a softer ride than our 600 pound racing springs.

Ideal for anyone looking for improved handling without sacrificing ride comfort. These springs sit approximately 1/4" - 1/2" lower than stock springs. Made in the USA exclusively for Scott Drake. Features black powder coating.

Year	Description	Part No.	List
65-66	Original GT	C5ZZ-5310-E	\$89. ⁹⁵ PR

STOCK COIL SPRING



Replace your old worn out springs with these quality aftermarket replacements, made in the U.S.A. Features black powder coating.

Part No.	Year	Description	List
C5ZZ-5310-A	64-66	6 cyl.	\$74. ⁹⁵ PR
C5ZZ-5310-B	64-66	V8 w/ AC	\$76. ⁹⁵ PR
C5ZZ-5310-C	64-66	V8 w/out AC	\$76. ⁹⁵ PR
C7ZZ-5310-A	67-70	6 cyl.	\$79. ⁹⁵ PR
C7ZZ-5310-B	67-73	Small Block	\$79. ⁹⁵ PR
C7ZZ-5310-C	67-70	Big block w/ AC	\$79. ⁹⁵ PR
C7ZZ-5310-D	67-70	390 w/out AC, or 351C w/ AC & PS	\$79. ⁹⁵ PR

RUBBER SPRING INSULATOR



Year	Description	Part No.	List
64-73	Rubber - original 1/8" thick	C4DZ-5415-AR	\$4. ⁹⁵ EA

POLYURETHANE COIL SPRING

INSULATOR



Scott Drake added another improved part to the Classic Mustang product line with these new and improved Coil

Spring Insulators. The inner lip is now thicker to prevent tearing and taller to keep it centered in the spring. It also has an added spring indexing stop to help prevent it from moving and allow the spring to seat properly. These coil spring insulators are made from long lasting polyurethane so they last longer than standard rubber ones. 1" version does not have indexing stop.

Year	Description	Part No.	List
64-73	Black polyurethane, 1/8" thick	C4DZ-5415	\$22 ⁹⁵ PR
64-73	Black polyurethane - 3/8" thick	C4DZ-5415-UR	\$22 ⁹⁵ PR
64-73	Black polyurethane, 1" thick	C4DZ-5415-URT	\$26 ⁹⁵ PR

COIL SPRING PERCH BUSHING



This critical bushing takes a lot of abuse from the extra weight and pressure of the coil spring. High-

performance polyurethane replacement bushings.

Year	Part No.	List
64-73	C4DZ-3388-PB	\$28 ⁹⁵ SE

HIGH PERFORMANCE COIL SPRING PERCH



These Performance Springs Perches offer a very affordable upgrade to stock Spring Perches with rubber bushings. These are made with Synthetic Elastomer Bushings which are similar to Polyurethane in performance and longevity but will not squeak like Polyurethane. Perch can rotate a full 360 degrees on shaft, which allows front suspension to articulate freely. This feature also eases installation of Coil Spring. Zerk grease fitting installed and locking nuts included.

Year	Description	Part No.	List
64-73	HiPo	C4DZ-3388-HP	\$59 ⁹⁵ EA

COIL SPRING PERCH



Features quality stamped steel construction, bushings, nuts, anti-squeak coil protector pads. Excellent quality OEM design.

Part No.	Year	Description	List
C4DZ-3388-RI	64-73	Individually packaged	\$27 ⁹⁵ EA

POLYURETHANE FRONT SUSPENSION BUMPER



Stops suspension travel damage.

Year	Description	Part No.	List
64-73	Polyurethane	C3DZ-3020-P	\$28 ⁹⁵ PR

RUBBER FRONT SUSPENSION BUMPER



Stops suspension travel damage.

Year	Desc	Part No.	List
65-66	Rubber	C3DZ-3020-A	\$4 ⁹⁵ EA
67-69	Rubber	C6OZ-3020-A	\$6 ⁹⁵ EA
69-73	Rubber	C9OZ-3020	\$7 ⁹⁵ EA

UPPER CONTROL ARMS



These upper control arms are the finest reproductions available. Not rebuilt, all new. Riveted ball joint as original. They come

complete with shaft, bushings, ball joint, nut with cotter key, 90 degree zerk, washers and locking nuts. Upper.

Year	Description	Part No.	List
64-66	Black, gray	C4DZ-3082-RI	\$27 ⁹⁵ EA
67-73	Black, gray	C7DZ-3082-A	\$27 ⁹⁵ EA
67-73	Black	C7DZ-3082-RI	\$27 ⁹⁵ EA

UPPER BALL JOINT KIT



These are the best available. Includes ball joint, rubber boot and mounting hardware.

Year	Description	Part No.	List
64-73	4 bolt, import	C7OZ-3049-A	\$18 ⁹⁵ EA
64-73	4 bolt, USA	C7OZ-3049-AR	\$38 ⁹⁵ EA
64-73	3 bolt, import	D0OZ-3049-A	\$17 ⁹⁵ EA
64-73	3 bolt, USA	D0OZ-3049-AR	\$34 ⁹⁵ EA

UPPER CONTROL ARM SHAFT KIT



Complete kit with shaft, bushings, grease seals, bolts, and zerk fittings. Fits original Ford control arms only.

Year	Part No.	List
64-66	C3DZ-3047-AR	\$69 ⁹⁵ EA
67-73	C6OZ-3047-AR	\$89 ⁹⁵ EA

UPPER CONTROL ARM ZERK FITTING

Our special extended zerk grease fittings are designed so that cutting shock towers for access will not be necessary. This kit makes lubing upper arms a snap, and can be installed while arm is on the car! Plated to prevent corrosion. Standard 90 degree included with upper control arms.



64-73: 90 degree
374714-S

List

\$2⁹⁵ KI



64-73: Extended version w/ tool
374714-SK

List

\$15⁹⁵ KI

SCOTT DRAKE'S

LOWER CONTROL ARMS

These These lower control arms are authentic reproductions. 1964-67 feature the original riveted design, lower jacking tabs and 2-tone paint. Comes complete with balljoint, pressed in bushing, grease seal, zerk fitting, washer, nut and cotter key. Painted black and natural steel grey.



Year	Description	Part No.	List
64-66	Black, gray	C4DZ-3078-A	\$27 ⁹⁵ EA



67: Black, gray w/ jacking tabs
C7OZ-3078-A

List

\$59⁹⁵ EA



68-73: Black, gray w/out jacking tabs
C8OZ-3078-A

List

\$62⁵⁰ EA

WE PROUDLY FEATURE AUTHENTIC MUSTANG REPRODUCTIONS FROM SCOTT DRAKE!





68-69: Black/gray, w/ jacking tabs
C80Z-3078-B

List
\$64.⁹⁵ EA

68-73: Black w/out jacking tabs
D7DZ-3078-A

List
\$51.⁹⁵ EA

LOWER CONTROL ARM

These lower control arms are authentic reproductions. Comes complete with balljoint, pressed in bushing, grease seal, zerk fitting, washer, nut and cotter key.



64-66: Black, USA made
C4DZ-3078-AR

List
\$67.⁵⁰ EA



67: Black, USA made
C70Z-3078-AR

List
\$72.⁹⁵ EA



68-73: Black, USA made
D7DZ-3078-AR

List
\$66.⁹⁵ EA

LOWER CONTROL ARM BUSHING



All bushings are graphite impregnated polyurethane. Only fits USA made control arms.

Year	Description	Part No.	List
64-66		4-3101	\$21. ⁹⁵ PR
67-73	1 7/16" outside diameter, black	4-3102	\$24. ⁹⁵ PR
67-73	1 9/16" outside diameter, black	4-3106	\$14. ⁹⁵ PR

LOWER CONTROL ARM BOLTS

Concours correct lower control arm bolts. 67-73 adjustable version pictured.



Year	Part No.	List
64-66	373142-S	\$12. ⁹⁵ KT
67-73	C60A-3B236-K	\$19. ⁹⁵ KT

RUBBER STRUT ROD BUSHINGS



64-66: OEM, rubber, 10 piece kit
Concours correct bushings & washers, not generic
C4DZ-3A187-AR

List
\$29.⁹⁵ KI



64-66: OEM, rubber, Set of 4
Concours correct bushings
C4DZ-3A187-A

List
\$23.⁹⁵ SE



67-73: OEM, rubber, set of 4
Concours correct bushings
C60Z-3A187-A

List
\$24.⁹⁵ SE



67-73: OEM, rubber, 10 piece kit
Concours correct bushings & washers, not generic
C60Z-3A187-AR

List
\$39.⁹⁵ KI

POLYURETHANE STRUT ROD BUSHING

Each kit comes neatly packaged for display.



64-66: Polyurethane, Set of 4
4-7111

List
\$23.⁹⁵ SE



67-73: Polyurethane, 6 piece kit
4-7112

List
\$25.⁹⁵ SE

HEAVY-DUTY STRUT ROD BUSHINGS

These premium bushings are made from Synthetic Elastomer that provides very similar handling performance and longevity when compared to Polyurethane but without the squeaking. This modern material is firmer than OEM Rubber but has a slightly softer durometer than traditional Polyurethane which will improve overall ride quality by eliminating some of the harshness associated with Polyurethane. A great compromise that allows you to get both comfort and performance at the same time. Steel Sleeves and correct Washers included if required. The correct 11/16x18 Nuts available under part # 380460-S for 67-73.



Year	Description	Part No.	List
64-66	HD strut rod bushing kit. Heavy Duty synthetic elastomer bushing	C4DZ-3A187-HD	\$34. ⁹⁵ KI



Year	Description	Part No.	List
67-73	HD strut rod bushing kit. Heavy Duty synthetic elastomer bushings	C60Z-3A187-HD	\$45. ⁹⁵ KI

STRUT ROD NUTS



Scott Drake is now offering these very hard to find nuts. The threads are not standards and cannot be purchased at your average automotive or hardware store. Our 64-66 version resemble originals. 67-73 concours.

Year	Part No.	List
64-66	34426-S	\$0. ⁵⁸ PR
67-73	380460-S	\$5. ⁹⁵ PR

STRUT RODS

Forged heavy-duty construction. If your car has been in an accident, check this part for damage.



Year	Description	Part No.	List
64-66	LH or RH, fits 6 cyl & V8	CSZZ-3468-B	\$69.95 EA
67	LH or RH, w/ nuts, fits 6 cyl & V8	C70Z-3468-A	\$69.95 EA
68-73	RH, w/ nut, fits 6 cyl & V8	C9ZZ-3468-C	\$49.95 EA
68-73	LH, w/ nut, fits 6 cyl & V8	C9ZZ-3468-D	\$49.95 EA

STRUT ROD BRACKET



High quality steel, painted black. Welding required for install.

Part No.	Year	Description	List
CSZZ-6503487-L	64-66	LH	\$44.95 EA
CSZZ-6503487-R	64-66	RH	\$44.95 EA
C7ZZ-6503487-L	67-70	LH, lower	\$49.95 EA
C7ZZ-6503487-R	67-70	RH, lower	\$49.95 EA

MONTE CARLO BARS



This bar was originally developed by Carroll Shelby to stop shock tower flex and maintain proper wheel alignment during hard cornering. This extra support also helps prevent shock tower stress cracks. Copied from the original design, our bars feature a new thicker diameter tube and improved fender brackets. We have also stamped square holes in the top of each fender bracket to allow for the use of lower profile carriage bolts. We have a variety of finishes to match the look of any engine compartment, and all our bars are individually packaged to protect the finish.

Satin: Our satin powder coat is a perfect match for any billet aluminum under the hood, while retaining the strength of steel.

Black: Our black powder coat has a beautiful finish to compliment the rest of the engine compartment.

Chrome: Our chrome finish has a very bright shine to give your engine compartment some extra pop.

Stainless Steel: Our stainless steel bars will never rust and are so highly polished they look like chrome.

All of our Monte Carlo bars are available in straight or curved versions.

1964-66			
Year	Description	Part No.	List
64-66	Straight, black	CSZZ-16A052-ARB	\$20.95 EA
64-66	Straight, chrome	CSZZ-16A052-ARC	\$29.95 EA
64-66	Straight, satin	CSZZ-16A052-ARM	\$24.95 EA
64-66	Straight, Stainless	CSZZ-16A052-ARS	\$44.95 EA
64-66	Curved, black	CSZZ-16A052-BRB	\$26.95 EA
64-66	Curved, chrome	CSZZ-16A052-BRC	\$34.95 EA
64-66	Curved, satin	CSZZ-16A052-BRM	\$29.95 EA

1967-68			
Year	Description	Part No.	List
67-68	Straight, black	C7ZZ-16A052-ARB	\$22.95 EA
67-68	Straight, chrome	C7ZZ-16A052-ARC	\$30.95 EA
67-68	Straight, satin	C7ZZ-16A052-ARM	\$24.95 EA
67-68	Curved, black	C7ZZ-16A052-BRB	\$25.95 EA
67-68	Curved, chrome	C7ZZ-16A052-BRC	\$35.95 EA

1969-70			
Year	Description	Part No.	List
69-70	Straight, black	C9ZZ-16A052-ARB	\$22.95 EA
69-70	Straight, chrome	C9ZZ-16A052-ARC	\$35.95 EA
69-70	Curved, black	C9ZZ-16A052-BRB	\$30.95 EA
69-70	Curved, chrome	C9ZZ-16A052-BRC	\$36.95 EA

1971-73			
Year	Description	Part No.	List
71-73	Straight, black	D1ZZ-16A052-A	\$41.95 EA

RACE MONTE CARLO BAR WITH HEIM JOINTS



We took Carroll Shelby's original, great idea one step further by making it

fully adjustable to fit all car widths. There are a lot of variations due to initial assembly, shock tower fatigue or previous accident. With the adjustable heim joints, install is a breeze. This style also allows for bar to be removed easily for engine repairs.

Year	Description	Part No.	List
65-66	Curved, black	CSZZ-16A052-BJB	\$79.95 EA
65-66	Curved, Stainless	CSZZ-16A052-BJS	\$99.95 EA
67-68	Curved, black	C7ZZ-16A052-BJB	\$79.95 EA
67-68	Curved, Stainless	C7ZZ-16A052-BJS	\$99.95 EA

KYB LOW-PRESSURE GAS SHOCK



This KYB gas shock improves handling without sacrificing ride comfort. A very good choice for the daily driver wanting a

smooth ride with the response of a gas shock.

Year	Description	Part No.	List
65-70	Front	KYB343146	\$34.95 EA
71-73	Front	KYB343156	\$44.95 EA
64-73	Rear	KYB343219	\$31.95 EA

KYB HIGH-PRESSURE GAS-A-JUST SHOCK



KYB Gas-a-just shocks are America's best selling performance gas shock. It's monotube design features a higher gas pressure

which helps to hold the tire to road surface during severe driving conditions. N2 gas helps eliminate shock fading due to aeration and foaming. This shock is the perfect choice for the performance oriented Mustang.

Year	Description	Part No.	List
64-70	Gas-A-Just, Front	KG-4517	\$50.95 EA
64-73	Gas-A-Just, Rear	KG-5517	\$50.95 EA
71-73	Gas-A-Just, Front	KG-4504	\$50.95 EA

HIGH PERFORMANCE SHOCK ABSORBERS



Get improved handling and control for your classic Mustang with Scott Drake performance tuned shock absorbers. The highly efficient design of these shocks delivers superior performance. These shocks were developed specifically for the classic Mustang owner that is seeking sporty handling without a punishing ride. High quality rubber bushings and locking nuts are included. Like all Scott Drake products, these are backed by the Scott Drake 100% satisfaction guarantee. 1971-73 front shocks will be available in early 2016.

Year	Description	Part No.	List
64-70	FRONT Performance	CSZZ-18124-HP	\$39.95 EA
64-73	REAR Performance	CSZZ-18125-HP	\$39.95 EA
71-73	FRONT Performance	C3DZ-18124-HP	\$39.95 EA

WE PROUDLY FEATURE AUTHENTIC MUSTANG REPRODUCTIONS FROM SCOTT DRAKE!



BILLET SHOCK TOWER CAPS



CNC machined from 6061-T6 billet aluminum, with a clear anodized finish. This is also a perfect replacement solution for stripped

out shock mounting threads on the original caps. Includes stainless steel Allan head hardware with external star locking washers. Sold in pairs..

Year	Description	Part No.	List
64-66	Billet Aluminum	CSZZ-18A017-BL	\$99.95 ^{PR}
67-70	Billet Aluminum	C7ZZ-18A017-BL	\$99.95 ^{PR}

SHOCK TOWER CAP



These precision crafted, steel stamped reproductions are perfect replacements for broken, bent or ugly originals.

Each cap contains both front shock nuts pressed into place.

See "Hardware" section for special bolts and nut required to install.

Part No.	Year	Description	List
CSZZ-18A017-A	64-66	Black	\$18.95 ^{EA}
CSZZ-18A017-C	64-66	Chrome	\$24.95 ^{EA}
C7ZZ-18A017-A	67-70	Black	\$18.95 ^{EA}
C7ZZ-18A017-C	67-70	Chrome	\$24.95 ^{EA}

SHOCK TOWER BRACE



Very nice reproductions. Stamped and formed steel, ready for paint or chrome finish.

Year	Part No.	List
67-68	C7ZZ-16A052-PR	\$46.95 ^{PR}
69-70	C9ZZ-16A052-PR	\$46.95 ^{PR}
71-73	D1ZZ-16A052/3	\$74.95 ^{PR}

EXPORT BRACE



We made these export braces from the Ford print. Heavier than other reproductions. Exact details

with correct deep draw stamping. Available in 3 finishes to compliment any engine compartment. Our export braces fit without drilling, prying and jumping on the front end. Greatly reduces twisting of the chassis. Also strengthens the front end and helps reduce shock tower fatigue and cracking.

Year	Description	Part No.	List
64-70	Chrome	CSZZ-16A052-C	\$79.95 ^{EA}
64-70	Black	CSZZ-16A052-E	\$59.95 ^{EA}
64-70	Satin	CSZZ-16A052-S	\$79.95 ^{EA}

AUTHENTIC EXPORT BRACE



Correct for all authentic Shelby's and Fords built for oversea's export. Same quality as our extra-strength export braces. These feature equal mounting hole spacing where brace attaches to firewall.

Year	Description	Part No.	List
65-66	Shelby, chrome	S1MS-16A052-C	\$174.95 ^{EA}
65-66	Shelby, black	S1MS-16A052-E	\$144.95 ^{EA}

EXPORT BRACE MOUNTING PLATE



Reinforcement plate that mounts on cowl.

Year	Description	Part No.	List
64-66		CSZZ-16A052-MP	\$31.95 ^{EA}
67-70		C7ZZ-16A052-MP	\$31.95 ^{EA}
65-66	Shelby - even spaced holes	S1MS-16A052-MP	\$79.95 ^{EA}

COWL BRACE TO COWL HARDWARE

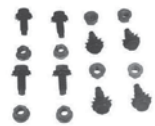

These are the real thing, not just generic nuts and bolts.

Year	Part No.	List
64-68	CSZB-260	\$18.95 ^{KI}

FRONT SWAY BAR



Front sway bars minimize body lean when cornering.

Year	Description	Part No.	List
64-66	1"	S1MS-5482-A	\$114.95 ^{KI}
64-66	1 1/8"	S1MS-5482-B	\$124.95 ^{EA}
67-70	1", small block	C7ZZ-5482-A	\$114.95 ^{KI}
67-70	1 1/8", small block	C7ZZ-5482-B	\$132.95 ^{KI}
67-70	1", big block, clears oil filter	C7ZZ-5482-BB	\$118.95 ^{KI}
71-73	1"	D1ZZ-5482-A	\$112.95 ^{KI}
71-73	1 1/8"	D1ZZ-5482-B	\$120.95 ^{KI}

ADJUSTABLE SWAY BAR END LINK



This allows quick secure adjustments of sway bar. Teflon lined rodbearing also makes steering response instantaneous.

Part No.	Year	List
CSZZ-5A486-ADJ	65-73	\$58.95 ^{PR}

POLYURETHANE SWAY BAR END

LINK KIT



Our End Link kits include high performance polyurethane bushings. Use

polyurethane bushings to eliminate deflection losses at the ends of the sway bar. Kit includes 2 links.

Year	Description	Part No.	List
64-66	Black polyurethane	CSZZ-5A486-K	\$23.95 ^{KI}
67-73	Black polyurethane	C7ZZ-5A486-K	\$24.95 ^{KI}

POLY SWAY BAR BUSHING KIT



Our special polyurethane bushings reduce deflection at the bar mounts to quicken the action of stock or aftermarket

sway bars. Available in a wide range of sizes, with matching mount brackets. Includes lubrication groove to prevent squeaking.

Year	Description	Part No.	List
64-73	Black, 5/8"	CSZZ-5486-A	\$23.95 ^{KI}
64-73	Black, 11/16"	CSZZ-5486-B	\$23.95 ^{KI}
64-73	Black, 3/4"	CSZZ-5486-H	\$23.95 ^{SE}
64-73	Black, 13/16"	CSZZ-5486-C	\$23.95 ^{KI}
64-73	Black, 7/8"	CSZZ-5486-D	\$23.95 ^{KI}
64-73	Black, 15/16"	CSZZ-5486-E	\$23.95 ^{KI}
64-73	Black, 1"	CSZZ-5486-F	\$23.95 ^{KI}
64-73	Black, 1 1/8"	CSZZ-5486-G	\$23.95 ^{KI}

RUBBER SWAY BAR BUSHING



Our black rubber bushings are exact copies of the original. Features correct shoulder and split for easy

installation. Sold in pairs. Some sway bar brackets may not accommodate the raised anti-slip shoulder, trimming with razor blade may be required.

Year	Description	Part No.	List
64-66	5/8"	C4DZ-5493-B	\$12.95 ^{PR}
65-66	7/8", GT, concours without anti-slip shoulder	CSZZ-5493-A	\$14.95 ^{PR}
64-73	11/16"	C60Z-5493-A	\$12.95 ^{PR}
64-73	3/4"	C60Z-5493-B	\$12.95 ^{PR}
64-73	7/8"	C60Z-5493-E	\$19.95 ^{PR}
64-73	15/16"	C60Z-5493-I	\$19.95 ^{PR}
64-73	1"	C60Z-5493-J	\$12.95 ^{PR}

RUBBER SWAY BAR END LINK KIT



Our End Link kits include rubber bushings and plated hardware. Kit includes 2 links.

Year	Description	Part No.	List
64-67	Rubber	C0DZ-5A486-BR	\$10 ⁹⁵ SE
68-73	Rubber	C2OZ-5A486-AR	\$10 ⁹⁵ SE

REAR SWAY BAR

Rear sway bars minimize body lean when cornering.



64-73: 3/4" adjustable
C5ZZ-5486-ADJ

List

\$116⁹⁵ KI



64-66: 3/4" non-adjustable
C5ZZ-5486

List

\$125⁹⁵ KI



67-70: 3/4"
C7Z-5486

List

\$124⁹⁵ KI

ORIGINAL 4-LEAF REAR SPRINGS

These premium springs are made using high-quality spring steel to assure a smooth, stable ride that will last for years. Features OEM style clamps, correct "hot cupped" ends, anti-squeak pads, front eye bushing installed and OEM 4 leaf design. They will also help lift that sagging rear end. Ford originally listed more than 24 different part numbers for the Mustang between 1964-73. The parts varied only slightly, depending on body style, options, engine size, handling options, and transmission. Scott Drake has chosen 2 different springs as the most universal and one of these should meet most customers' needs. Choose from either C5ZZ-5560 which has a slightly stiffer rate and higher arch. But it may raise your car higher than it's original stock height depending on total weight of the vehicle. This is especially true on early model 6-cylinder cars. Still this is the more popular spring as most customers do not like the traditional slightly lower in the rear look that Mustangs are infamous for. But if an original lower ride height is more what you are after we also offer a Light Duty version under part number C5ZZ-5560-S.

Although we make absolutely no guarantees about actual ride height on your particular car, as there are many variables to contend with, please find the below comparison we did between the two springs to give you an approximate idea of ride heights you can expect. The test was done on a 67-68 coupe and measured at the top center of the rear

wheel arch. (Note: 64-66, 69-70 and 71-73 wheel arches are not exactly the same so their measurement would vary. The test car had 215-70-14 tires on it. On the test car our C5ZZ-5560 measured 26.75" and the C5ZZ-5560-S measured 26". Once again, these measurements will vary from car to car depending on tire size, tire pressure, full or empty tank, and overall weight; but you can expect your car to sit about 3/4" higher with C5ZZ-5560 over C5ZZ-5560-S.



C5ZZ-5560-S
64-68: 4 leaf, light duty, stock height

List

\$89⁹⁵ EA



C5ZZ-5560
64-73: 4 leaf, standard, stock height

List

\$89⁹⁵ EA

PERFORMANCE REAR LEAF

SPRINGS

We offer a large selection of performance leaf springs in both 4.5 and 5 leaf versions to suit any driver, and any application on or off the track and at any ride height. These premium springs are made using high-quality spring steel to assure a smooth stable ride that will last for years. Painted detail gray to look as good as they perform. 1" and 2" lowering versions refer to drops compared to standard eye heavy-duty 5 leafs which may sit slightly higher than original depending on year and original options your car was equipped with.



64-73: 4.5 leaf, mid eye, lowers 1"
C5ZZ-5560-4ME

List

\$106⁹⁵ EA



64-73: 5 leaf, standard eye, heavy duty
C5ZZ-5560-HD

List

\$104⁹⁵ EA



64-73: 5 leaf, mid eye, lowers 1"
C5ZZ-5560-HPME

List

\$109⁹⁵ EA



64-73: 5 leaf, Reverse eye, lowers 2"
C5ZZ-5560-RE

List

\$119⁹⁵ EA

CONCOURS UNDER RIDE

TRACTION BARS



New concours reproduction under-ride traction bars for 64-66 Mustangs are now made by Scott Drake. These are reproductions of the traction bars originally installed on 66 Shelby GT350s by the factory to eliminate axle wrap and wheel hop. They feature authentic details to perfectly match the appearance of the originals. The heavy-wall tubular bars have cast ends with correct "M-1" markings. The unique 3-bolt cast axle mount brackets have accurate "10-70" markings just like they did in 1966. The original bars were made from thin wall tubing and are prone to bending. Scott Drake traction bars are made to handle more power with super strong .187 wall tubing that is twice the thickness of the competition. Each kit is finished in a durable semi-gloss black powder coating for a lasting show quality appearance. Rubber bushings, alignment spacers and zinc plated grade 8 hardware are included. **1967-70 axle mount brackets are fabricated just like the originals.**



Unique 3-bolt cast axle mount brackets feature authentic "10-70" markings.



Heavy-wall tubular traction bars feature cast ends with the correct "M-1" markings.



Precision frame mount brackets are contoured to mate with the frame and finished in copper paint.



Rubber Bushings & Zinc Plated Grade 8 Hardware Included

Year	Part No.	List
64-66	TM-1068-C	\$159 ⁹⁵ PR
67-70	TM-1069-C	\$159 ⁹⁵ PR

WE PROUDLY FEATURE AUTHENTIC MUSTANG REPRODUCTIONS FROM SCOTT DRAKE!



PERFORMANCE UNDER RIDE

TRACTION BAR



Get improved acceleration and handling with new Scott Drake Performance Under-Ride Traction bars for 64-70 Mustangs. These traction bars work to eliminate axle wrap and wheel hop on high performance applications. They have robust features like heavy-wall tubular bars with cast ends and 4-bolt cast axle mount brackets to help control rear axle movement. **1967-70 axle mount brackets are fabricated just like the originals.**

Year	Part No.	List
64-66	TM-1068-R	\$119 ⁹⁵ SE
67-70	TM-1069-R	\$114 ⁹⁵ SE

SUB FRAME CONNECTOR



These connectors join front and rear frame rails to make the uni-body much more rigid. This greatly improves handling by reducing body flex allowing the suspension to react quicker. Black powder coated. These can be bolted in, but welding is recommended.

Year	Description	Part No.	List
64-70	Coupe and Fastback	CSZZ-5479-A	\$149 ⁹⁵ PR

AXLE BUMPER



Injected molded rubber. Protects floor, and stops 3rd member from contacting floor.

Year	Description	Part No.	List
65-70	Outer rear, mounts on frame	C3DZ-4730	\$7 ⁹⁵ EA
65-70	Center rear, mounts above 3rd member	CSZZ-4730	\$8 ⁹⁵ EA

LEAF SPRING PLATE



This is the plate that secures the rear spring U-bolts to the differential, it also is the mounting point for the rear shock absorber.

Year	Description	Part No.	List
64-66	RH	CSZZ-5798-R	\$26 ⁹⁵ EA
64-66	LH	CSZZ-5799-L	\$26 ⁹⁵ EA
67-70	RH, except Boss & CJ	C6DZ-5796-A	\$26 ⁹⁵ EA
67-70	LH, except Boss & CJ	C6DZ-5796-B	\$26 ⁹⁵ EA

CONCOURS AXLE U BOLT



Made by Drake, these Axle U Bolts are now concours correct! No longer a generic U-Bolt, these feature proper flattened area for a more secure fitment to axle housing. Also includes concours correct flanged locking nuts. All of this for almost the same affordable price as the old, generic versions.

Year	Description	Part No.	List
64-66	6 or 8 cyl	CSZZ-5705-K	\$7 ⁹⁵ EA
67	6 or 8 cyl, silver nuts	C7ZZ-5705-K*	\$7 ⁹⁵ EA
68-73	6 or 8 cyl (except 428), red nuts	C8ZZ-5705-A	\$7 ⁹⁵ EA
68-69	428, not concours	C8ZZ-5705-K	\$7 ⁹⁵ EA

* will fit 68-73

REAR END LOWERING KIT



Don't heat your springs or remove leaves. Now its easier and safer to lower the rear end. This kit includes cast aluminum lowering blocks, U bolts with nylock nuts. Not a universal kit but specially designed for the Mustang.

Year	Description	Part No.	List
64-66	1" drop	CSZZ-5705-LK1	\$44 ⁹⁵ EA
67-70	1" drop	C7ZZ-5705-LK1	\$44 ⁹⁵ KI

ADJUSTABLE SHACKLE KIT



These extreme shackles feature heavy duty 1/4" thick plates and polyurethane bushings with special grooves which allow lubrication. Adjustments allow a 3/8" inch lift from stock position.

Year	Description	List
64-73	Adjustable	\$54 ⁹⁵ KI

STAINLESS STEEL SHACKLE KIT



Beautiful parts with details like originals. Available in a variety of styles & designs. 1" longer version will raise rear of car 1/2" higher if rear springs are in new condition. GT design allows more exhaust clearance, plus are easier to install.

Year	Description	Part No.	List
64-73	9/16" rods, GT dual exhaust	CSZZ-5776-GTSS	\$27 ⁹⁵ EA
64-73	Dual exhaust, 1" longer	CSZZ-5776-GTSSL	\$27 ⁹⁵ EA

SHACKLE KIT WITH DETAIL GRAY FINISH



Beautiful parts with details like originals. Available in a variety of styles & designs. 1" longer version will raise rear of car 1/2" higher if rear springs are in new condition. GT version was originally used on 65-66, but will work on all cars as it allows more exhaust clearance, plus are easier to install.

Year	Description	Part No.	List
64-65	9/16" rods, standard, gray	CSZZ-5776-K	\$16 ⁹⁵ KI
66-73	1/2" rods, standard, gray	C6ZZ-5776-K	\$16 ⁹⁵ KI



Year	Description	Part No.	List
64-65	9/16" rods, dual exhaust, gray	CSZZ-5776-GT	\$19 ⁹⁵ EA
64-73	Dual exhaust, 1" longer, gray	CSZZ-5776-GTL	\$19 ⁹⁵ EA
66-73	1/2" rods, dual exhaust, gray	C6ZZ-5776-GT	\$19 ⁹⁵ EA

POLYURETHANE LEAF SPRING BUSHING KIT



Includes eye bushings and shackle bushings.

Year	Part No.	List
64-73	CSZZ-5630/5781B	\$69 ⁹⁵ KI

POLYURETHANE LEAF SPRING SHACKLE BUSHING



A set of eight polyurethane shackle bushings. These have a 1/2 inch bore.

Year	Description	Part No.	List
66-73	1/2" hole, black polyurethane	C6ZZ-5781-BP	\$26 ⁹⁵ SE

LEAF SPRING EYE BUSHING



Year	Part No.	List
64-73	CSZZ-5630-R	\$13 ⁹⁵ EA

RUBBER LEAF SPRING SHACKLE BUSHING



Sets include 8 rubber, leaf spring shackle bushings.

Year	Description	Part No.	List
64-65	9/16" hole, rubber	C5ZZ-5781-BR	\$15.95 ^{SE}
66-73	1/2" hole, rubber	C6ZZ-5781-BR	\$15.95 ^{SE}

LEAF SPRING EYE BOLT



Grade 8 Hardened bolt kit includes two bolts and two nuts.

Year	Part No.	List
64-67	C5ZZ-5781-A	\$11.95 ^{SE}
68-73	C7ZZ-5781-A	\$11.95 ^{KI}

TRANSMISSION

ORIGINAL MANUAL SHIFTER KNOB

Truly a fine reproduction made from the same material as the originals.



64-66: Black, original Bakelite plastic, 4 speed
C5ZZ-7213-A

List

\$16.95^{EA}



64-67: Black, original Bakelite plastic, 3 speed, 1/2"x20 threads
C5ZZ-7213-H

List

\$16.95^{EA}



67-68: Black, original Bakelite plastic, 3 speed, 7/16"x20 threads
C80Z-7213-B

List

\$16.95^{EA}



65-67: Black, original Bakelite plastic, 5 speed 1/2"x20 threads
C5ZZ-7213-T5

List

\$32.95^{EA}



65-67: Black, original Bakelite plastic, 5 speed 12mmx1.75 threads
E5ZZ-7213-T5

List

\$29.95^{EA}



67-68: Black, original Bakelite plastic, 4 speed
C7ZZ-7213-A

List

\$16.95^{EA}



67-68: Black, original Bakelite plastic, 5 speed 1/2"x20 threads
C7ZZ-7213-T5

List

\$32.95^{EA}



68-69: Woodgrain, deluxe, plastic injection copy of original, 4 speed
C80Z-7213-A

List

\$31.95^{EA}



68-69: Woodgrain, deluxe, plastic injection, 1/2"x20 threads
C80Z-7213-T5

List

\$29.95^{EA}

SHIFT KNOB RETAINING NUT



68-69: Deluxe woodgrain shift knob retaining nut (Chrome)
1/2"x20
C80A-7C404-A

List

\$14.95^{EA}

BILLET MANUAL SHIFTER KNOB

A variety of shift knobs to put a nice touch on your shifter.



64-73: Mustang logo, 4 Speed, 1/2"x20
C5ZZ-7213-BL

List

\$34.95^{EA}



64-66: Black, 4 speed, 1/2" x20
B-7213-A

List

\$- EA



64-66: Satin, 4 speed, 1/2"x20
B-7213-AC

List

\$29.95^{EA}



68-69: Satin, deluxe, 4 speed, 1/2"x20
B-7213-CC

List

\$29.95^{EA}



64-66: Satin, 5 speed, 12 mm threads
B-7213-E5AC

List

\$29.95^{EA}



65-70: Satin, 4 speed, Hurst threads, 3/8"x16
B-7213-HC

List

\$29.95^{EA}

MANUAL SHIFTER



Factory detailing and triple chrome plating distinguish our tubular shift handles from the rest. Cable and T-lever included.

Year	Description	Part No.	List
65-67	4-speed	C5ZZ-7210-M	\$169.95 ^{EA}
65-67	5-speed	C5ZZ-7210-T	\$144.95 ^{EA}
68	4-speed	C8ZZ-7210-A	\$169.95 ^{EA}

SHIFTER BRACKET



This previously hard to find part comes complete with proper retaining pin.

Year	Description	Part No.	List
65-67	3 and 4 speed	C5ZZ-7210-D	\$49.95 ^{EA}

SUPER SHIFT LEVER REBUILD KIT



This kit is used to keep tension on the shifter where it connects to the shift

linkage. A sign that this kit is needed is a wobbly, loose shift lever. Kit includes shoulder bolts. 3-speed pictured.

Part No.	Year	Description	List
C5ZZ-7208-AK	64-68	4 speed	\$24.95 ^{KI}
C5ZZ-7208-BK	64-68	3 speed	\$27.95 ^{KI}

SHIFT LEVER REBUILD KIT



This kit is used to keep tension on the shifter where it connects to the shift linkage. A sign that this kit is needed is a wobbly, loose shift lever.

Part No.	Year	Description	List
C5ZZ-7208-A	64-68	4 speed	\$18.95 ^{KI}
C5ZZ-7208-B	65-68	3 speed	\$23.95 ^{KI}

SHIFT LEVER SHOULDER BOLT



Not always included in shifter rebuild kits, but necessary for a complete shifter rebuild. These are

NOT generic bolts, they are exact copies. High grade zinc plated bolts. Correct shoulders and nylon lock.

Year	Part No.	List
65-68	379818-S	\$3.95 ^{EA}

WE PROUDLY FEATURE AUTHENTIC MUSTANG REPRODUCTIONS FROM SCOTT DRAKE!



SHIFT LEVER SHOULDER BOLT SHIFT LEVER GROMMET



Replace those worn out or missing shift lever grommets to fix that sloppy shift lever.

Year	Description	Part No.	List
64-70	Bulk	379998-S	\$2.50 ^{EA}
64-73	Pair, packaged	379998-SK	\$5.00 ^{PR}

RUBBER SHIFTER BOOT

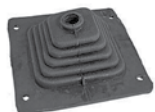

An exact copy of the original. Compression molded E.P.D.M. rubber. Features a textured skin that

matches the original appearance exactly. Ours has a steel insert just like the originals.

Year	Description	Part No.	List
64-68	3 and 4 speed	C5ZZ-7277-B	\$9.95 ^{EA}
69-70	3 and 4 speed	C9ZZ-7277-A	\$20.95 ^{EA}
70	Hurst, 4 speed	D0ZZ-7277-B	\$22.95 ^{EA}

GENUINE LEATHER SHIFTER BOOT



These leather shift boots look great! Our 64-73 boots feature draw string at the neck and rubber insulated metal mounting plate.

Year	Description	Part No.	List
64-68	Leather w/ draw string	C5ZZ-7277-L	\$32.50 ^{EA}
69-73	Leather w/ draw string	C9ZZ-7277-L	\$32.50 ^{EA}

LOWER SHIFTER BOOT



This rubber boot mounts on the shifter housing underneath the shift boot. Most cars are missing this important part. It was designed to keep dirt and

moisture out of the shifter box and reduce noise coming through the shifter hole. An excellent reproduction.

Year	Description	Part No.	List
65-68	3 speed	C6ZZ-7138-B	\$27.95 ^{EA}
65-68	4 speed, small block	C6ZZ-7138-C	\$27.95 ^{EA}
69	4 speed	C9ZZ-7138-B	\$47.95 ^{EA}
70	4 speed hurst	D0GZ-7138	\$52.95 ^{EA}

SHIFTER BOOT RETAINER

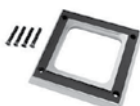

These pieces really dress up the area around the shifter.

Year	Description	Part No.	List
64-68	Chrome, Deluxe, 3 and 4 speed, without console, rare factory option	C4ZB-7262-B	\$34.95 ^{EA}
64-68	Satin, Deluxe, 3 and 4 speed, without console	C4ZB-7262-S	\$34.95 ^{EA}



64-68: Chrome, manual trans
Without console
C5ZZ-7262-C

List

\$10.95^{EA}



69-70: Chrome, manual trans
C9ZZ-7262-C

List

\$27.95^{EA}

HURST COMPETITION/PLUS SHIFTER



The industry standard for over 30 years, this shifter offers state of the art transmission control for popular 4-speed manual transmissions. Dedicated applications assure a custom

fit to a wide variety of vehicles having factory consoles without any floor pan modifications • Race track proven design and reliability • Heat treated linkage rods and arms for added strength and durability • Adjustable gear stops prevent overshifts and prolong transmission life • Bolt-on chrome-plated stick with attractive custom white knob • Complete with all hardware *SHIFTER AND INSTALLATION KITS ARE SOLD SEPARATELY*

Year	Description	Part No.	List
64-73	4 speed, Shifter only (for T-10 or Toploader)	H-3913180	\$359.95 ^{EA}
64-73	4-speed Toploader install kit for SB	H-3737637	\$204.95 ^{KT}

SHIFTER LINKAGE



4 speed top loader linkage includes 3 rods, 3 arms, 6 washers and 6 pins. Fits Mustang and Cougar only.

Fits factory linkage only.

Year	Part No.	List
64-68	C5ZZ-7285-LRK	\$84.95 ^{KI}

SHIFTER LINKAGE RETAINING CLIP



Heat treated wire clip that secures shift linkage rod. Automatic or manual transmission.

Year	Part No.	List
64-73	352358-S	\$1.50 ^{PR}

4-SPEED SHIFTER INTERLOCK

WASHER



Fits inside the shifter box between shift levers. This washer is made from the original Ford print for a perfect fit. Features heat-treated steel with a zinc finish.

Year	Part No.	List
64-69	C5ZZ-7C318-A	\$14.95 ^{EA}

SHIFTER MOUNT PLATE



Plate mounts the shifter to the transmission. Top loader only.

Year	Description	Part No.	List
64-73	4 speed	C5ZZ-7E046-T	\$26.95 ^{EA}

SHIFTER MOUNTING PLATE EXTENSION



This conversion plate allows the use of a Falcon, Fairlane or Torino 4 speed toploader to be installed into a Mustang. Relocates shifter rearward to correct position.

Year	Description	Part No.	List
64-73	4 speed	C5ZZ-7E046-A	\$28.95 ^{EA}

CLUTCH

CLUTCH PEDAL



Exact reproductions of the originals. Made in the U.S.A.

Year	Description	Part No.	List
65-66	6 and V8	C6ZZ-7519-A	\$138.95 ^{EA}
67-68	6 and V8, requires minor modification for 68	C7ZZ-7519-A	\$139.95 ^{EA}

AFTERMARKET CLUTCH PEDAL

These clutch pedals feature an improved design (removable pin) for easier installation. Compatible with existing hanger assembly even in automatics.

Year	Description	Part No.	List
65-66	W/removable pin	C6ZZ-7519-AR	\$174. ⁹⁵ EA
67-68	W/removable pin	C7ZZ-7519-AR	\$174. ⁹⁵ EA
69-70	W/removable pin	C9ZZ-7519-B	\$174. ⁹⁵ EA
71-73	W/removable pin	D1ZZ-7519-B	\$179. ⁹⁵ EA

CLUTCH PEDAL PAD

These reproduction pads are high quality replacements for worn or missing original pads.

Year	Part No.	List
65-68	C5ZZ-7A624-B	\$4. ⁹⁵ EA
69-73	C9ZZ-7A624-A	\$8. ⁹⁵ EA

CLUTCH PEDAL PAD TRIM

Replacement clutch pedal pad trim. Stainless steel construction.

Year	Part No.	List
65-68	C5ZZ-7B544-A	\$8. ⁹⁵ EA
69-73	C9ZZ-7B544-A	\$12. ⁹⁵ EA

CLUTCH PEDAL ROLLER BEARING MASTER REBUILD KIT

This kit uses roller bearings to reduce pedal pressure and will last for years. 1969 through 1973 may require

modification to the pedal bracket assembly so bushing will fit. 13 piece kit includes instructions.

Year	Part No.	List
64-73	C5ZZ-2478-RBMK	\$51. ⁹⁵ KI

CLUTCH PEDAL REPAIR SHAFT

Includes machined pedal shaft, washer and special pin.

Year	Part No.	List
64-70	C5ZZ-2478-AK	\$14. ⁹⁵ KI

CLUTCH PEDAL SUPPORT ROLLER BEARING REPAIR KIT

These bearings will reduce pedal pressure and last for years. 1969 through 1973 may require modification to the pedal bracket assembly so bushing will fit. 10 piece kit includes instructions.

Year	Part No.	List
64-73	C5ZZ-2478-RB	\$39. ⁹⁵ KI

CLUTCH PEDAL SUPPORT BUSHING REPAIR KIT

An easy fix for sloppy or worn clutch pedal support bushings. Includes 2 machined bushings, 4 plastic bushings and 2 snap rings. 1969 through 1973 may require modification to the pedal bracket assembly so bushing will fit. 8 piece kit includes instructions.

Year	Part No.	List
64-73	378200-K	\$18. ⁹⁵ KI

BRAKE & CLUTCH PEDAL/PEDAL SUPPORT REBUILD KIT

This kit has everything you need to repair your clutch and brake pedal and pedal support in one easy kit.

Includes 378200-K, C5ZZ-2478-AK and 2 additional B7AZ-2471-A.

Year	Part No.	List
64-70	C5ZZ-2478-MK	\$34. ⁹⁵ KI

CLUTCH PEDAL RETURN SPRING

Heat treated to match original resistance.



64-68: Painted black
C2AZ-7534-A

List

\$15.⁹⁵ EA



69-73: Includes nylon bushings
C80Z-7534-B

List

\$29.⁹⁵ EA

CLUTCH PEDAL SPRING INSULATOR

Injection molded plastic stops underdash squeaking from clutch pedal return spring. 2 required per car.

Part No.	Year	List
C1DZ-7A630-A	64-68	\$5. ⁵⁰ EA

CLUTCH PEDAL RETURN SPRING BRACKET

Now available from Scott Drake. Made of heavy gauge steel with a satin black painted finish. Correct threads and hole patterns.

Year	Part No.	List
64-66	C5ZZ-7535-A	\$27. ⁹⁵ EA
67-68	C7ZZ-7535-B	\$29. ⁹⁵ EA
69-70	C9ZZ-7535-A	\$31. ⁹⁵ EA

CLUTCH PEDAL STOP

Good copy of original, fabric web cushion.

Year	Part No.	List
64-66	C20Z-7A630-A	\$25. ⁹⁵ EA

CLUTCH PEDAL BUMPER

This rubber bumper installs into the clutch pedal. Helps prevent "clunk" when pedal

returns back, and properly aligns clutch pedal height.

Part No.	Year	List
C7ZZ-7583	67-68	\$3. ²⁵ EA
D0ZZ-7583	69-70	\$3. ²⁵ EA

CLUTCH EQUALIZER BAR TO PEDAL ROD

This is the rod that attaches to the clutch pedal, goes through the firewall, and connects to the equalizer bar.

Year	Description	Part No.	List
65		C5ZZ-7521-A	\$18. ⁹⁵ EA
66	13 3/4"	C6ZZ-7521-D	\$29. ⁹⁵ EA
67-68	12 1/2"	C7ZZ-7521-A	\$31. ⁹⁵ EA
69-70	12 1/2"	C9ZZ-7521-C	\$23. ⁹⁵ EA

CLUTCH ROD BUSHING

Nylon plastic injected. Correct original design. Protects clutch and equalizer rods and removes excess play.

Year	Part No.	List
64-73	COAZ-7526-B	\$3. ²⁵ PR

WE PROUDLY FEATURE AUTHENTIC MUSTANG REPRODUCTIONS FROM SCOTT DRAKE!



CLUTCH ROD TO FIREWALL SEAL

Molded rubber, mount in firewall. 71-73 version is a combination of steering column and clutch rod seal.

Year	Part No.	List
64-66	CSZZ-7A533-AR	\$11.95 ^{EA}
67-70	C60Z-7A533-C	\$13.95 ^{EA}
71-73	D1ZZ-3513-A	\$24.95 ^{EA}

CLUTCH EQUALIZER BAR

Quality fabricated metal stamping. Precision welded. High performance version was used on all 289 HiPo

“K” cars and Shelby’s. Required when running HiPo manifolds.

Year	Description	Part No.	List
64-65	V8, 5-bolt	C4ZZ-7528-B*	\$84.95 ^{EA}
65-66	289 except high performance, 6-bolt	CSZZ-7528-E*	\$74.95 ^{EA}
64-65	High Performance, 5-bolt	C4ZZ-7528-C*	\$109.95 ^{EA}
65-66	High Performance, 6-bolt	CSZZ-7528-D*	\$139.95 ^{EA}
65-66	289, 302, 351W For use with Borge-son PS Conversion kits only	CSZZ-7528-PSC	\$95.95 ^{EA}
67-70	Big block	C7ZZ-7528-B	\$115.95 ^{EA}
67-70	289, 302, except Boss	C7ZZ-7528-G*	\$74.95 ^{EA}
69	351W	C9ZZ-7528	\$111.95 ^{EA}

CLUTCH EQUALIZER PIVOT BRACKET

This bracket bolts to the frame and acts as the inner pivot point for the clutch equalizer bar.

Year	Description	Part No.	List
64-70	All except big block	CSZZ-7507-A	\$18.95 ^{EA}
67-70	Big block, frame side	C7ZZ-7507-BR	\$26.95 ^{EA}
67-70	Big block, engine side	C7ZZ-7A572-BR	\$31.95 ^{EA}
71-73	302, 351, engine side	C7ZZ-7A572-BR	\$31.95 ^{EA}

CLUTCH EQUALIZER REPAIR KIT

A must for all manual transmissions. Includes felt washers, nylon ball bushings, washer and clevis clips. Improves clutch operation.

Year	Desc.	Part No.	List
67-73	Big block	C1AA-7543-KIT	\$16.95 ^{KI}
64-73	6 cyl., small block	C1DD-7543-KIT	\$13.95 ^{KI}

CLUTCH EQUALIZER BAR MOUNT KIT

This kit includes an engine pivot mount. We include bushings, clips and felt washers for both engine and frame side.

Year	Description	Part No.	List
64-70	6 cyl., 260, 289 5 bolt	C20Z-7A531-K	\$17.95 ^{KI}
65-70	289 6 bolt, 302, 351W	CSZZ-7A531-K	\$17.95 ^{KI}

CLUTCH EQUALIZER SOCKET

Year	Part No.	List
71-73	CODD-7517-A	\$12.50 ^{PR}

CLUTCH EQUALIZER SOCKET RETAINER

Year	Part No.	List
71-73	CSAZ-7B545-A	\$3.50 ^{EA}

CLUTCH EQUALIZER BAR FELT WASHER

This felt washer is the correct thickness to replace the missing washers in your equalizer bar. Two required per bar.

Year	Description	Part No.	List
64-70	Small block, 6 cyl.	351517-5	\$1.95 ^{EA}

CLUTCH ROD

Machined to match originals, plated to resist rust. Equalizer to clutch fork. Big block version requires adapter listed below.

Year	Description	Part No.	List
65-66	289	C6ZZ-7521-E	\$14.95 ^{EA}
67-68	289, 302	C7ZZ-7521-L	\$23.95 ^{EA}
67-70	390, 428	C8ZZ-7521-AR	\$45.95 ^{EA}
69-70	302, 351	C90Z-7521-A	\$15.95 ^{EA}

CLUTCH ROD ADAPTER

Our adapter is case hardened to OEM specifications and plated for years of service.

Year	Description	Part No.	List
67-71	Big block	C80Z-7B535-A	\$19.95 ^{EA}

CLUTCH LEVER DUST BOOT

Molded EPDM-neoprene blend. Resists damage from grease and dirt.

Year	Description	Part No.	List
65	6 cyl.	C30Z-7513-A	\$22.95 ^{EA}
65-71	SB, V8	C60Z-7513-C	\$21.95 ^{EA}
66-70	6 cyl.	C6GY-7513-A	\$23.95 ^{EA}
67-70	390, 427, 428	C60Z-7513-A	\$26.95 ^{EA}
71-73	1971 351 & 429; 1972-73 All	CSAZ-7513-A	\$34.95 ^{EA}

CLUTCH FORK

The fork that houses the clutch release bearing. C50Z-7515-B requires C6AZ-7562-A

Year	Description	Part No.	List
65-68	289, 3 or 4 speed trans, 9 1/4"	C50Z-7515-B	\$62.95 ^{EA}
68-69	Small block, clip on	C80Z-7515-A	\$72.95 ^{EA}
68-69	390	C80Z-7515-B	\$104.95 ^{EA}
68-69	428	C80Z-7515-D	\$119.95 ^{EA}

CLUTCH FORK PIVOT

Heavy duty, Hardware included. B9AZ version may require use of a machine shop for proper install.

Year	Description	Part No.	List
65-67	Small block, 289	B9AZ-7522-B	\$18.95 ^{EA}
68-72	Small block, 6 cyl.	C8AZ-7522-B	\$23.95 ^{EA}

CLUTCH ANTI-RATTLE SPRING

Anti-rattle spring for the clutch lever.

Year	Part No.	List
65-68	C6AZ-7562-A	\$5.95 ^{EA}

CLUTCH SPRING

Spring quality and load matches original.

Year	Description	Part No.	List
65-66	260, 289, 14 1/4" long	CSZZ-7523-A	\$6.95 ^{EA}
69-70	200, 302, 351 Upper, 4 1/2" long	C6ZZ-7591-A	\$8.95 ^{EA}
69-70	200, 302, 351 Upper, 4 1/2" long	C9ZZ-7523-A	\$8.95 ^{EA}
67-70	390, 428, Lower	C7ZZ-7591-A	\$10.95 ^{EA}
69-70	200, 250, 302, 351, Lower	C9ZZ-7591-A	\$13.95 ^{EA}
67-68	200, 289, 302, Upper	C7ZZ-7523-A	\$9.95 ^{EA}
69-70:	390-428, Upper	C9ZZ-7523-B	\$10.95 ^{EA}

CLUTCH PILOT BUSHINGS

A source of vibration in the drivetrain is sometimes a badly worn or cracked clutch pilot bushing.

Year	Description	Part No.	List
64-66	6 cyl.	CODD-7600-A	\$7.95 ^{EA}
64-68	289	C2OZ-7600-A	\$8.50 ^{EA}
67-73	302, 351 Roller bearing	C7AZ-7600-A	\$8.95 ^{EA}
67-71	Big block	C7AZ-7600-B	\$7.95 ^{EA}

6-CYLINDER, COMPLETE CLUTCH KIT

Previously nearly impossible to find we are pleased to announce these New 6cyl Complete Clutch Kits both in the early 8.5"

Versions and later 9" Versions. These are made by a well respected clutch manufacturer to provide a trouble free installation and long service life.

Year	Description	Part No.	List
64-66	1964-early 66, 6-cyl, 8.5" clutch	C4DZ-7563-KIT	\$304.95 ^{EA}
66	Late 66, 6-cyl, 9" Clutch	C6DZ-7563-KIT	\$329.95 ^{KT}

PERFORMANCE CLUTCH SETS

Excellent upgrade clutch set up. A must for towing or high performance applications. All new components

include pressure plate, clutch disc, throwout bearing and alignment tool.

Year	Description	Part No.	List
64-73	High performance, 10 1/2" HDX	CSZZ-7563-ZHPK	\$409.95 ^{KI}
64-73	High performance, 10"	CSZZ-7563-ZK	\$324.95 ^{KI}
67-73	High perf., 11", except 13/8" input	C7ZZ-7563-ZK	\$399.95 ^{KI}

STOCK CLUTCH SETS

Quality clutch sets. Includes clutch disc, pressure plate, throw out bearing & alignment tool. All new parts.

Part No.	Year	Description	List
CSZZ-7563-K	64-73	V8, 10"	\$189.95 ^{SE}
C7ZZ-7563-K	67-73	351, 390, 11"	\$214.95 ^{SE}

TRANSMISSION COMPONENTS**TRANSMISSION FLYWHEEL**

Year	Description	Part No.	List
64-68	157 teeth, 289, 3 and 4 speed	C3AZ-6375-J	\$184.95 ^{EA}
64-73	164 teeth, 302, 351 For 28 ounce externally balanced engines Will not fit Late Model 5.0 engines	C6TZ-6375-C	\$189.95 ^{EA}

TRANSMISSION RING GEAR

Made by a premier manufacturer in the U.S.A. All are top quality. Easily replaces those missing or damaged teeth on flywheels.

Year	Description	Part No.	List
64-68	157 teeth, 260, 289	C2OZ-6384-B	\$28.95 ^{EA}
68-73	164 teeth, 302, 351	CSAZ-6384-D	\$28.95 ^{EA}
67-70	184 teeth, 390, 428	CSAZ-6384-A	\$29.95 ^{EA}

MANUAL TRANSMISSION SPACER PLATE

Plate that is required to give proper spacing for flywheel and starter, also used to reinforce starter mounting.

Year	Description	Part No.	List
64-65	Small block, 5 bolt	C4DZ-7007-A	\$49.95 ^{EA}
65-68	289, 6 bolt, 157 teeth	C5DZ-7007-A	\$49.95 ^{EA}
68-73	302, 351, 164 teeth	C9DZ-7007-A	\$49.95 ^{EA}

TRANSMISSION FLYWHEEL BOLTS

Fits all manual transmission flywheels and will work on automatic transmission flexplates when factory reinforcement plate is used. 15/16" long.

Year	Part No.	List
64-73	B8AZ-6379-A	\$14.95 ST

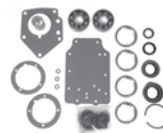
MANUAL TRANSMISSION MASTER REBUILD KIT

Master rebuild kits include brass synchro rings, input and output oil seals, tailshaft bushing, input and output bearings and all paper gaskets. Most also include thrust washers, needle bearings and small parts kit. Please refer to photo for contents of each kit.

Year	Description	Part No.	List
64-66	3 speed, 2.77 ratio, 6 cyl.	C3DZ-7005-R3	\$102.50 ^{KI}
64-73	3 speed, 64-73 V8, 67-73 6 cyl.	CSZZ-7005-R3	\$107.95 ^{KI}
64-65	Borg Warner T-10 4 speed, V8	CSZZ-7005-R4B	\$149.95 ^{KI}
64-73	4 speed Toploader, V8 except 427, 428, 429	CSZZ-7005-R4T	\$134.95 ^{KI}
67-73	4 speed Toploader w/ 1 3/8" input, Big block	C7ZZ-7005-R4T	\$159.95 ^{KI}

MANUAL TRANSMISSION OVERHAUL KIT

These kits are the same as Master Rebuild Kits except they do not include brass synchro rings.

Year	Description	Part No.	List
64-66	3 speed, 2.77 ratio, 6 cyl.	C3DZ-7005-OH3	\$87.50 ^{KI}
64-73	3 speed, 64-73 V8, 67-73 6 cyl.	CSZZ-7005-OH3	\$- ^{KI}
64-65	Borg Warner T-10 4 speed, V8	CSZZ-7005-OH4B	\$99.95 ^{KI}
64-73	4 speed Toploader, V8, except 427, 428, 429	CSZZ-7005-OH4T	\$99.95 ^{KI}
67-73	4 speed Toploader W/ 1 3/8" input, Big block	C7ZZ-7005-OH4	\$134.95 ^{KI}

WE PROUDLY FEATURE AUTHENTIC MUSTANG REPRODUCTIONS FROM SCOTT DRAKE!



TRANSMISSION MAINSHAFT

Made in U.S.A. Quality built.

Year	Description	Part No.	List
64-66	25 spline, 3 speed, 6 cyl.	C20Z-7061-B	\$204. ⁹⁵ EA

TRANSMISSION SYNCHRONIZER

All made from name brand suppliers. All U.S.A. Limited Supply.

Year	Description	Part No.	List
64-73	1st gear and reverse, 3 speed 64-73: V8 67-73: 6 cyl.	C6AZ-7124-B	\$149. ⁹⁵ EA
64-73	1st and 2nd gear, w/ reverse, 4 speed Toploader	C4AZ-7124-B	\$169. ⁹⁵ EA
64-73	3rd and 4th gear, 4 speed Toploader	C4AZ-7107-D	\$159. ⁹⁵ EA
64-66	3rd and 4th gear, Borg Warner T-10 4 speed	C2AZ-7124-C	\$149. ⁹⁵ EA

TRANSMISSION SYNCHRONIZER**FORK**

Year	Description	Part No.	List
64-73	1st and 2nd gear, 4 speed Toploader	C4AZ-7230-B	\$64. ⁹⁵ EA
64-66	1st-4th gear, Borg Warner T-10 4 speed	C2AZ-7230-A	\$40. ⁹⁵ EA

TRANSMISSION CLUSTER GEAR

Aftermarket U.S. brand.

Year	Description	Part No.	List
65-66	3 speed, 200	C50Z-7113-A	\$154. ⁹⁵ EA
64-73	4 speed Toploader, 2.32 ratio	C4AZ-7113-B	\$199. ⁹⁵ EA
64-66	4 speed Toploader, 2.78 ratio	C4DZ-7113-B	\$189. ⁹⁵ EA

TRANSMISSION GEAR

Made in the U.S. Premium brand. Limited Supply

Year	Description	Part No.	List
64-66	Reverse idler gear, 3 speed, 6 cyl.	C1DR-7141-A	\$44. ⁹⁵ EA
64-73	Reverse idler gear, 3 spd 64-73: V8 67-73: 6 cyl	C5AZ-7141-C	\$104. ⁹⁵ EA
64-66	Reverse idler gear, Borg Warner T-10 4 speed	C2AZ-7141-B	\$139. ⁹⁵ EA
64-73	1st gear, 32 teeth, 4 speed Toploader	C4AZ-7A209-A	\$134. ⁹⁵ EA
64-73	2nd gear, 28 teeth, 4 speed Toploader	C4AZ-7102-D	\$149. ⁹⁵ EA
64-66	2nd gear, 31 teeth, 4 speed Toploader	C4DZ-7102-A	\$144. ⁹⁵ EA
64-73	3rd gear, trans w/ 2.32 1st gear ratio, 4 speed Toploader	C4AZ-7B340-C	\$144. ⁹⁵ EA
64-66	3rd gear, trans w/ 2.78 1st gear ratio, 4 speed Toploader	C4DZ-7B340-B	\$139. ⁹⁵ EA
65-66	3rd gear, 28 teeth, Borg Warner T-10 4 speed	C30Z-7B340-B	\$172. ⁵⁰ EA
65-73	4SPD T/L REVERSE IDLER GEAR	C4DZ-7D223-B	\$77. ⁹⁵ EA

TRANSMISSION COUNTERSHAFT**PIN**

Quality machined pin, aftermarket brand.

Year	Description	Part No.	List
64-73	4 speed Toploader, 10 1/8" long, .8920" diameter	C4AZ-7111-A	\$44. ⁹⁵ EA

CLUTCH CABLE KIT

Kits include adjustable bracket that bolts to stock clutch pedal, firewall support plate and a "tool free" cable adjuster.

Compatible with most brake boosters and works on T5, Tremec and T56 applications with late model bell housings.

Year	Description	Part No.	List
64-66	T-5 and Tremec	CSZZ-CCK	\$264. ⁹⁵ KT
67-68	T-5 and Tremec	C7ZZ-CCK	\$264. ⁹⁵ KT
69-70	T-5 and Tremec	C9ZZ-CCK	\$264. ⁹⁵ KT
71-73	T-5 and Tremec	D1ZZ-CCK	\$264. ⁹⁵ KT

CLUTCH CABLE

Replacement for our clutch cable kit above.

Year	Description	Part No.	List
64-70	Cable only	CSZZ-CCK-CABLE	\$174. ⁹⁵ EA

TRANSMISSION SPACER PLATE CONVERSION KIT

Allows you to retain your original 6-bolt bellhousing when using a 1985-1993 T5 5-speed transmission. Requires drilling 2 holes into bellhousing.

Part No.	Year	Description	List
T5-PLATE-KIT6	65-70	T-5 V8, 6 bolt	\$171. ⁹⁵ EA

T5 CONVERSION KIT

These conversion kits makes it easy to install a late model V8 T5 transmission in a 1965-70 Mustang. T5 transmissions will increase gas mileage and top end speed. No cutting of the floor pan required. Bell housing modification required. Bell housing not included.

Year	Description	Part No.	List
65-66	T-5 bellhousing	T5-65-KIT	\$362. ⁹⁵ KI
65-66	Original 6-bolt bellhousing, 289, 302	T5-650E-KIT	\$414. ⁹⁵ KI
67-70	T-5 bellhousing	T5-67-KIT	\$304. ⁹⁵ KI
67-70	Original bellhousing, 289, 302	T5-670E-KIT	\$409. ⁹⁵ KI

TRANSMISSION FULCRUM



This is required to convert a late model T-5 bell housing to accept the early Mustang clutch fork. Available for

65-67 spring type clutch forks and for 68-70 prong type clutch forks.

Year	Description	Part No.	List
65-67	Spring type	T5-FSB-KIT-A	\$48. ⁹⁵ KI
68-70	Prong type	T5-FSB-KIT-B	\$50. ⁹⁵ KI

T5 TRANSMISSION CROSSMEMBER BAR



This is required to convert your car to a T5 five speed transmission. 65-66 version

includes parking brake bracket.

Year	Description	Part No.	List
65-66	T-5, V8	T5-BAR-A	\$124. ⁹⁵ EA
67-70	T-5, V8	T5-BAR-B	\$124. ⁹⁵ EA

TRANSMISSION CROSSMEMBER BAR



This is the bar that bolts to the transmission hump and supports the transmission.

67-68 version will not work on Big Blocks or FMX's.

Year	Description	Part No.	List
64-66	170, 200, 260, 289	CSZZ-6A203-A	\$52. ⁹⁵ EA
67-68	200, 289, 302	C7ZZ-6A203-A	\$52. ⁹⁵ EA
67-70	C6 Auto	C7ZZ-7A383-B	\$129. ⁹⁵ EA

TRANSMISSION MOUNT BOLTS



Year	Part No.	List
64-73	372821-S	\$5. ⁹⁵ PR

TRANSMISSION CROSSMEMBER BAR MOUNTING BOLTS



A pair of concours correct bolts with flanged locking nuts. Will not fit 67-70.

Year	Part No.	List
64-66	372993-S	\$9. ⁹⁵ PR
67-70	356682-S	\$9. ⁹⁵ PR

TRANSMISSION MOUNT



Perfect replacement for your broken tranny mount. Also can be used when converting to T-5

Year	Description	Part No.	List
64-73	All	C4DZ-6068-A	\$14. ⁹⁵ EA



U-JOINT

Quality aftermarket replacements.

Year	Description	Part No.	List
64-66	6 cyl., front, inside snap rings	CSZZ-4635-FA	\$27. ⁹⁵ EA
64-66	V8, front, inside snap rings	CSZZ-4635-FB	\$27. ⁹⁵ EA
64-66	6 cyl., rear, inside snap rings	CSZZ-4635-RA	\$27. ⁹⁵ EA
64-66	V8, rear, inside snap rings	CSZZ-4635-RB	\$37. ⁹⁵ EA
65-66	V8, rear, outer snap rings	CSZZ-4635-RC	\$21. ⁹⁵ EA
67-73	Front, 3" outside diameter yoke span	C7ZZ-4635-FA	\$21. ⁹⁵ EA
67-73	Front, 3 7/8" outside diameter yoke span	C7ZZ-4635-FB	\$21. ⁹⁵ EA
67-73	V8, rear, 3" outside diameter yoke span	C7ZZ-4635-RA	\$37. ⁹⁵ EA
67-73	V8, rear, 3 7/8" outside diameter yoke span	C7ZZ-4635-RB	\$21. ⁹⁵ EA

U-JOINT BOLT KIT



Kit includes 2 concours correct U-Bolts and 4 locking nuts.

Year	Description	Part No.	List
64-73	V8	C1AZ-4529-AK	\$8. ⁹⁵ KT

YOKE



Year	Description	Part No.	List
64-73	V8, C-4, 3 or 4 speed, 28 spline	C3AZ-4841-D	\$104. ⁹⁵ EA
65-73	Small block, inside snap rings	C5DZ-4841-A	\$104. ⁹⁵ EA
65-70	V8, T-5	T5-YOKE	\$159. ⁹⁵ EA

CLUTCH

SPEEDOMETER CABLE



Quality aftermarket copies. Attaches from rear of speedometer to transmission. Now come

with correct firewall grommet, a Scott Drake exclusive! 64-68 versions include retaining bracket just like originals. 69-73 Retaining Bracket sold separately.

Year	Description	Part No.	List
64-66	Auto trans & 3 speed, 60" long	C5DZ-17260-A	\$24. ⁹⁵ EA
64-66	4 speed, 68" long	C50Z-17260-A	\$24. ⁹⁵ EA
67-68	Auto trans & 3 speed, 68" long	C7ZZ-17260-A	\$24. ⁹⁵ EA
67-68	4 speed	C7ZZ-17260-B	\$24. ⁹⁵ EA
69-73	Automatic trans & 3 speed	C9ZZ-17260-A	\$24. ⁹⁵ EA
69-70	4 speed, except drag pack	C9ZZ-17260-B	\$28. ⁹⁵ EA

SPEEDOMETER CABLE RETAINER



1969-73 Mustang Speedometer Cable To Transmission Retainer. This is an exact copy of Retaining

Bracket used on 69-73 Mustangs, Cougars and misc other Fords to hold the Speedo Cable into the Transmission Housing. Fits Automatic and Manual Transmissions. Silver Zinc Plated.

Year	Description	Part No.	List
69-73	All	B9TZ-17264-A	\$7. ⁵⁰ EA

SPEEDOMETER CABLE RETAINER



Snaps into floor pan support to keep cable away from shift linkage, parking brake, and exhaust.

Year	Description	Part No.	List
64-70	Will not fit 4-speed	373829-S	\$4. ⁹⁵ EA

SPEEDOMETER GEAR RETAINING CLIP



Secures speedometer cable gear to the end of the cable.

Year	Part No.	List
64-73	C1DZ-17292-A	\$3. ⁹⁵ EA

WE PROUDLY FEATURE AUTHENTIC MUSTANG REPRODUCTIONS FROM SCOTT DRAKE!



SPEEDOMETER GEAR

Injection molded nylon. Please confirm teeth count and teeth direction. Note: 4 speed toploaders have reversed tooth direction. 4-speed T-10 uses same as

automatic. Also note: color matching does not guarantee correct gear. Note: not returnable if package is opened.

Year	Description	Part No.	List
64-73	16 teeth, auto trans & 3 speed	CODZ-17271-A	\$13.95 ^{EA}
64-73	16 teeth, 4 spd Toploader (orange)	C2DZ-17271-J	\$13.95 ^{EA}
64-73	17 teeth, auto trans & 3 speed	CODZ-17271-C	\$13.95 ^{EA}
64-73	17 teeth, 4 spd Toploader (purple)	C2DZ-17271-G	\$12.50 ^{EA}
64-73	18 teeth, auto trans & 3 spd (yellow)	CODD-17271-B	\$13.95 ^{EA}
64-73	18 teeth, 4 speed Top-Loader	C2DZ-17271-A	\$13.95 ^{EA}
64-73	19 teeth, auto trans & 3 spd (pink)	CODZ-17271-B	\$13.95 ^{EA}
64-73	19 teeth, 4 speed Toploader	C2DZ-17271-B	\$13.95 ^{EA}
64-73	20 teeth, auto trans & 3 spd (black)	C1DZ-17271-A	\$13.95 ^{EA}
64-73	20 teeth, 4 speed Toploader	C2DZ-17271-C	\$13.95 ^{EA}
64-73	21 teeth, auto trans & 3 speed	CODZ-17271-D	\$13.95 ^{EA}
64-73	21 teeth, 4 speed Toploader	C2DZ-17271-D	\$13.95 ^{EA}

INTERNAL SPEEDOMETER GEAR

Year	Description	Part No.	List
64-73	7 teeth, 4 speed Toploader (black)	C4DZ-17285A	\$23.95 ^{EA}
64-66	6 teeth, 4 speed Toploader (pink)	C5ZZ-17285A	\$19.95 ^{EA}

AUTOMATIC SHIFTER**SHIFTER BUTTON**

C5ZZ-7C488-C features plastic injection. C8OZ-7C488-A features die-cast zinc construction and chrome plating..

Year	Description	Part No.	List
64-73	Black	C5ZZ-7C488-C	\$5.95 ^{PR}
68-71	Chrome plated, LH	C8OZ-7C488-A	\$28.95 ^{EA}
69-73	Black	C9ZZ-7C488-C	\$6.95 ^{SE}

AUTOMATIC SHIFTER HANDLE

Scott Drake offers the most extensive line of Automatic Shift Handles. Several we are exclusive on. Most Vendors traditionally have sold

C5ZZ-7213-F as being correct for 1964-1973. Although it does fit all years it is only Concours Correct for 1965-1968 Cars. Early 64 cars had a slightly smaller Handle that is not available. However we do now offer the Concours Correct 69-73 Standard Interior Automatic Shift Handle under part # C9OZ-7213-B which is different in overall shape to the C5ZZ-7213-F. 69-73 Owners on a Budget can still use C5ZZ-7213-F. We also offer 67-73 Deluxe Interior Automatic Shift Handles in assorted Colors. Although not original for those that like the feel of Leather over Plastic we offer a Black Leather covered version as well.

Part No.	Year	Description	List
C5ZZ-7213-F	65-68	Chrome, concours	\$18.00 ^{EA}
C9OZ-7213-B	69-73	Chrome, concours	\$24.95 ^{SE}
C5ZZ-7213-F	64 69-73	Chrome, Not concours	\$18.00 ^{EA}
C8OZ-7213-BK	67-73	Black, deluxe	\$59.95 ^{EA}
C8OZ-7213-BKL	67-73	Black, leather, deluxe	\$59.95 ^{SE}
C8OZ-7213-BL	67-69	Dark blue, deluxe	\$64.95 ^{EA}
C8OZ-7213-MR	68-69	Maroon, deluxe	\$64.95 ^{EA}
C8OZ-7213-PR	67-68	Parchment, deluxe	\$64.95 ^{EA}
C8OZ-7213-SA	67-68	Saddle, deluxe	\$64.95 ^{EA}

AUTOMATIC VR™ SHIFTER HANDLE

Add custom high performance styling with the new Scott Drake VR™ automatic shifter handle. This precision die

cast handle features exclusive V-rated rubber tire tread grips and a slightly larger than stock shape for a more comfortable feel and precise shifter control. Each unit is polished and chrome plated for years of lasting good looks. Original black plastic push buttons are included.

Year	Description	Part No.	List
64-73	AutoShift Handle w/Tire Tread Grip	C5ZZ-7213-TT	\$84.95 ^{EA}

AUTOMATIC SHIFTER SELECTOR LEVER

Chrome plated lever with new cable, bushings and internal mechanisms.

Year	Description	Part No.	List
64-68	64-66: All / 67-68: w/out console	C5ZZ-7210-A	\$84.95 ^{EA}
69-73	69-73: All	C9ZZ-7210-A	\$84.95 ^{EA}

CONSOLE AUTOMATIC SHIFTER ASSEMBLY

This is a complete shifter including the shift knob. Great chrome and sturdy construction.

Year	Description	Part No.	List
67-68	Console cars only	C7ZZ-7210-KIT	\$189.95 ^{EA}

CONSOLE SHIFTER SELECTOR ROD

This is the rod that connects the shifter to the indicator in the console for automatic transmissions.

Year	Part No.	List
67-68	C7ZZ-7E148-A	\$14.95 ^{EA}

SHIFTER CABLE

Repair cable for shifter lever.

Year	Description	Part No.	List
65-73	Automatic trans	C5ZZ-7D246-A	\$27.95 ^{EA}

SHIFTER BUSHING

Year	Description	Part No.	List
64-73	Automatic trans shifter	C5ZZ-7A133-A	\$1.25 ^{EA}
65-67	Automatic trans, 6 pc kit, Linkage rod	B9AZ-7343-A	\$6.95 ^{SE}

SHIFTER COVER ASSEMBLY W/OUT CONSOLE

Quality chrome finish over zinc die cast. Features correct details and paint. Seal & Dial included. For 64-68 Mounting Screws order part #52720-SK.



64: Concours, w/out arrows
C4ZZ-7D394

List
\$39.95^{EA}

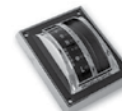

65-66: Concours
C5ZZ-7D394

List
\$39.95^{EA}

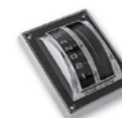

67-68: Not exact copy
C7ZZ-7D394

List
\$39.95^{EA}

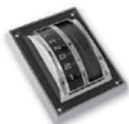

67-68: Concoors
C7Z-7D394-P

List
\$44. ⁹⁵ EA



69-70: Concoors, will also fit 1971-73 for an upgraded look
C9Z-7D394

List
\$69. ⁹⁵ EA



71
D1Z-7D443-A

List
\$62. ⁵⁰ EA

SHIFTER COVER ASSEMBLY AND HANDLE KIT



Includes shift handle, cover assembly, new bushings and mounting hardware.

Year	Part No.	List
64-66	KIT-TRN-1	\$59. ⁹⁵ KI
67-68	KIT-TRN-2	\$59. ⁹⁵ KI

SHIFTER COVER RETAINING PLATE

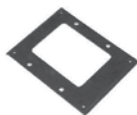

Painted black steel stamping. Fits under the shift bezel, on top of the shift lever bucket.

Year	Description	Part No.	List
64-68	w/out Console	C5Z-7B233-A	\$5. ⁹⁵ EA

SHIFTER DIAL

Precision molded clear plastic with black or clear background under red arrows and white letters.



64: Early 64, Black, no arrows, non-console
C4Z-7A213-A

List
\$9. ⁹⁵ EA



65-66: Black, non-console
C5Z-7A213-A

List
\$9. ⁹⁵ EA



64-66: Black, for center console
C5Z-7A213-D

List
\$12. ⁰⁰ EA



67-68: Black, non-console
C7Z-7A213-A

List
\$9. ⁹⁵ EA



69-70: Clear, no arrows, All
C9Z-7E271-A

List
\$12. ⁰⁰ EA

AUTOMATIC SHIFT INDICATOR



Year	Part No.	List
69-73	C9Z-7A110-A	\$8. ⁹⁵ EA

CONSOLE SHIFTER PLATE ASSEMBLY



Precision stamped steel construction, painted black, includes shift dial, selector slide and proper hardware.

Year	Part No.	List
65-66	C5Z-7D350-K	\$39. ⁹⁵ KI

CONSOLE SHIFT SIDE SEAL



Die cut from a tough, wear resistant material which matches the original. Automatic transmissions only.

Year	Part No.	List
64-66	C5Z-7C445-A	\$2. ⁵⁰ EA
67-68	C7Z-7C445-A	\$2. ⁵⁰ EA

SHIFTER SEAL

High quality rubber molded around a flexible steel insert. Insert is cadmium plated to prevent rust.



64-68: Non-console
C5Z-7D351

List
\$4. ⁰⁰ EA



69-73: All
D1Z-7D351-A

List
\$9. ⁹⁵ EA

SHIFTER HOUSING TO FLOOR SEAL



Die-cut rubber.

Year	Part No.	List
65-68	C5Z-7370	\$2. ⁹⁵ EA
69-73	C9Z-7370	\$2. ⁹⁵ EA

SHIFTER LINKAGE ROD



Our linkage rod includes the connector that is often worn and not included with the competitions linkage rod.

Dark grey finish to prevent rust.

Year	Description	Part No.	List
64-66	C-4	C5Z-7326-A	\$39. ⁹⁵ EA
67-68	C-4 and C6	C7Z-7326-A	\$39. ⁹⁵ EA

SHIFTER LINKAGE RETAINING CLIP



Heat treated wire clip that secures shift linkage rod. Automatic or manual transmission.

Year	Part No.	List
64-73	352358-S	\$1. ⁵⁰ PR

TRANSMISSION KICK DOWN CABLE KIT



A 9-piece kit, our Transmission Kick Down Cable Kit includes our cable, lever, spring & bracket, along with all the hardware for simple installation.

Year	Part No.	List
66-68	C60Z-7A187-KIT	\$35. ⁹⁵ KT

TRANSMISSION KICK DOWN CABLE



10.2" long Kick Down Cable.

Year	Part No.	List
66-68	C60Z-7A187-D	\$10. ⁹⁵ EA

KICKDOWN LEVER



Stamped steel construction with welded machined stud.

Year	Description	Part No.	List
67-68	6 and V8	C60Z-7D026	\$17. ⁹⁵ EA

WE PROUDLY FEATURE AUTHENTIC MUSTANG REPRODUCTIONS FROM SCOTT DRAKE!



NEUTRAL SAFETY SWITCH HARNESS



Very nice, authentic reproduction. Features correct molded connectors.

Year	Part No.	List
64-65	CSZZ-7A240-NS	\$26. ⁹⁵ EA
66	C6ZZ-7A240-NS	\$28. ⁹⁵ EA

NEUTRAL SAFETY SWITCH



These Neutral Safety Switches were unexpectedly made obsolete by Motorcraft and availability was getting scarce, but they are now made

by Scott Drake and available once again! Our Classic Mustang neutral safety switches are high quality reproduction parts made from original Ford prints.

Year	Description	Part No.	List
64-67	C-4, before 12-15-66	C4AZ-7A247-C	\$49. ⁹⁵ EA
67-69	C-4, C-6, after 12-15-66	C9ZZ-7A247-B	\$49. ⁹⁵ EA
70-72	C-4	DOZZ-7A247-B	\$59. ⁹⁵ EA
69-73	FMX	D2ZZ-7A247-B	\$108. ⁹⁵ EA

TRANSMISSION OIL

CONCOURS C-4 TRANSMISSION PAN

Stamped steel construction.

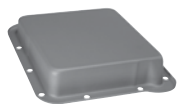

64-73: C-4, natural gray
CSZZ-7A194-S

List
\$20.⁹⁵ EA



64-73: C-4, chrome
CSZZ-7A194-C

List
\$28.⁹⁵ EA



64-73: C-4, chrome w/ drain plug, aftermarket
CSZZ-7A194-A

List
\$26.⁹⁵ EA

C-6 TRANSMISSION PAN

Steel stamped construction.



Year	Description	Part No.	List
67-73	C-6, chrome w/ drain plug	C7ZZ-7A194-A	\$33. ⁹⁵ EA

DEEP C-4 TRANSMISSION PAN



Stamped steel construction. These are 1" deeper than stock depth. Allows you to run approximately 1.5 to 2 quarts more fluid to keep your transmission cooler and extend your transmission's life.

Year	Description	Part No.	List
64-73	C-4, 1" deeper, chrome	CSZZ-7A194-CD	\$25. ⁹⁵ EA
64-73	C-4, 1" deeper, natural gray	CSZZ-7A194-SD	\$21. ⁹⁵ EA

TRANSMISSION DIP STICK



All dip sticks have correct markings for accurate readings.

Year	Description	Part No.	List
64-73	C-4, zinc	C6AZ-7A020-B	\$14. ⁹⁵ EA
64-73	C-4, chrome	C6AZ-7A020-C	\$16. ⁵⁰ EA

TRANSMISSION DIP STICK TUBE



Year C4 transmissions.
O-ring included

Year	Description	Part No.	List
64-73	289, 302, C-4, black	C60Z-7A228-B	\$16. ⁹⁵ EA
64-73	289, 302, C-4, chrome	C60Z-7A228-C	\$24. ⁹⁵ EA

TRANSMISSION FILTER



Clean filters are essential for proper transmission function and longevity.

Year	Description	Part No.	List
64	C-4, w/ gaskets	C4ZZ-7A098-F	\$11. ⁹⁵ KI
65-69	C-4, w/ gaskets	CSZZ-7A098-F	\$11. ⁹⁵ KI
67-73	C-6, w/ gaskets	C7ZZ-7A098-F	\$11. ⁹⁵ KI
69-73	FMX, w/ gaskets	C9ZZ-7A098-F	\$12. ⁹⁵ KI
70-73	C-4, w/ gaskets	DOZZ-7A098-F	\$11. ⁹⁵ KI

TRANSMISSION OIL COOLER FITTING



Brass fitting which screws into radiator oil cooler.

Year	Part No.	List
67-73	MOCF01	\$7. ⁹⁵ PR

TRANSMISSION OIL COOLER HOSE KIT



Connects transmission oil cooler lines to transmission oil cooler in radiator. Includes hoses, fittings and post clamps.

Year	Description	Part No.	List
64-65	6 cyl. or V8	MOC001	\$12. ⁹⁵ KI

TRANSMISSION OIL COOLER LINE



Quality precision bent lines. Runs from oil cooler in radiator to transmission.

Does not include rubber hoses or clamps on 1964-1965 models. Each pair does include two retainer clips.

Year	Description	Part No.	List
64-65	6 cyl., steel	MOL001	\$46. ⁹⁵ PR
67-70	C-4, V8, steel	MOL002	\$46. ⁹⁵ PR
67-70	C-4, V8, Stainless	MOL002S	\$77. ⁰⁰ PR
64-65	V8, steel	MOL003	\$46. ⁹⁵ PR
64-65	V8, Stainless	MOL003S	\$77. ⁰⁰ PR
66	6 cyl., steel	MOL004	\$46. ⁹⁵ PR
66	6 cyl., Stainless	MOL004S	\$- PR
66	V8, steel	MOL005	\$46. ⁹⁵ PR
66	V8, Stainless	MOL005S	\$77. ⁰⁰ PR
67-70	C-6, 390, 428, steel	MOL006	\$46. ⁹⁵ PR
67-70	C-6, 390, 428, Stainless	MOL006S	\$77. ⁰⁰ PR
69-70	FMX, 351, steel	MOL007	\$46. ⁹⁵ PR
69-70	FMX, 351, Stainless	MOL007S	\$77. ⁰⁰ PR
71-73	C-4, 302, steel	MOL008	\$46. ⁹⁵ PR
71-73	C-4, 302, Stainless	MOL008S	\$77. ⁰⁰ PR
71-73	C-6, 351C, steel	MOL009	\$49. ⁵⁰ PR
71-73	C-6, 351C, Stainless	MOL009S	\$82. ⁵⁰ PR
67-70	C-4, 6 cyl., steel	MOL010	\$46. ⁹⁵ PR
67-70	C-4, 6 cyl., Stainless	MOL010S	\$77. ⁰⁰ PR
71	FMX, steel	MOL011	\$49. ⁵⁰ EA
71-73	FMX, Stainless	MOL011S	\$82. ⁵⁰ PR

TRANSMISSION OIL LINE BRACKET



Mounts to front right hand side of engine, holds transmission cooler lines in place to prevent damage.

Part No.	Year	Description	List
MTLB01	64-66	V8	\$7. ⁹⁵ EA

TRANSMISSION OIL LINE RETAINER CLIP



These retainer clips were specially tooled up, not a generic clip. Holds transmission lines together.

Made from spring steel, black oxide finish.

Year	Part No.	List
64-73	LRC101	\$3.95 ^{PR}

AUTOMATIC TRANSMISSION COMPONENTS

AUTOMATIC TRANSMISSION MASTER REBUILD KIT



These kits include everything necessary to rebuild your tired and leaking automatic

transmission. Parts included are all paper gaskets, pan gasket, rubber O rings, rubber lip seals, metal clad seals, sealing rings, friction clutches, steel clutch plates, filter, clutch band, and bushings. Vacuum modulator sold separately. C5ZZ- kit pictured, refer to www.ScottDrake.com for pictures of each kit.

Year	Description	Part No.	List
64-69	C-4	C5ZZ-7005-MK	\$99.95 ^{KI}
67	C-6	C7ZZ-7005-MK	\$152.95 ^{KI}
68-73	C-6	C8ZZ-7005-MK	\$184.95 ^{KI}
69-73	FMX	C9ZZ-7005-MK	\$109.95 ^{KI}
70-73	C-4	DOZZ-7005-MK	\$92.50 ^{KI}

AUTOMATIC TRANSMISSION OVERHAUL KIT



This kit includes all paper gaskets, pan gasket, rubber O rings, rubber lip seals, metal clad seals, sealing rings & friction clutches.

Vacuum modulator sold separately.

Part No.	Year	Description	List
C5ZZ-7005-K	64-69	C-4	\$74.95 ^{KI}
C7ZZ-7005-K	67-73	C-6	\$98.95 ^{KI}
C9ZZ-7005-K	69-73	FMX	\$97.50 ^{KI}
DOZZ-7005-K	70-73	C-4	\$48.95 ^{KI}

AUTOMATIC TRANSMISSION SHIFT KIT



These shift kits are a must for anybody wishing to improve economy, performance and durability of their automatic

transmission. Shift kits firm up 1-2 and 2-3 shifts and improve passing gear response.

Year	Description	Part No.	List
65-66	C-4, Cruise-o-matic, basic kit	C5ZZ-7A100-SK	\$37.50 ^{KI}
67-69	C-4, Select-o-matic, reprogramming kit	C7ZZ-7A100-RPK	\$104.95 ^{KI}
67-69	C-4, Select-o-matic, basic kit	C7ZZ-7A100-SK	\$39.95 ^{KI}
67-73	C-6, basic kit	C8ZZ-7A100-SK	\$32.95 ^{KI}
69-73	FMX, basic kit	C9ZZ-7A100-SK	\$63.95 ^{KI}
70-73	C-4, Select-o-matic, reprogramming kit	DOZZ-7A100-RPK	\$- ^{KI}
70-72	C-4, basic kit	DOZZ-7A100-SK	\$36.95 ^{EA}
73-80	C-4 and C-5, basic kit	D3ZZ-7A100-SK	\$32.95 ^{EA}

VACUUM MODULATOR



American made. Premium aftermarket brand.

Year	Description	Part No.	List
64-71	64-71 C-4, 66-72 C-6	C4AZ-7A377-B	\$22.95 ^{EA}

VACUUM MODULATOR LINE



Runs from intake manifold to modulator on transmission. Includes rubber attaching hose on each end..

Year	Description	Part No.	List
65-66	C-4, steel	MVT001	\$22.00 ^{EA}
65-66	C-4, Stainless	MVT001S	\$28.50 ^{EA}
64-65	C-4, V8, steel	MVT002	\$22.00 ^{EA}
64-65	C-4, V8, Stainless	MVT002S	\$28.50 ^{EA}
64-68	6 cyl., steel	MVT003	\$26.95 ^{EA}
64-68	6 cyl., Stainless	MVT003S	\$36.95 ^{EA}
67-69	C-4, V8, steel	MVT004	\$22.00 ^{EA}
67-69	C-4, V8, Stainless	MVT004S	\$22.00 ^{EA}
71-73	C-4, V8, steel	MVT005	\$24.00 ^{EA}
71-73	C-4, V8, Stainless	MVT005S	\$29.95 ^{EA}
71-73	C-6, 351, steel	MVT006	\$24.00 ^{EA}
71-73	C-6, 351, Stainless	MVT006S	\$28.50 ^{EA}
68-69	C-6, V8, steel	MVT007	\$22.00 ^{EA}
68-69	C-6, V8, Stainless	MVT007S	\$22.00 ^{EA}

AUTOMATIC TRANSMISSION TORQUE CONVERTER NUTS



Set of 4 unique flanged lock nuts. Fits all automatic applications. Concours correct.

Year	Description	Part No.	List
64-73	Set of 4	377704-S	\$3.50 ST

AUTOMATIC TRANSMISSION FLEX PLATE



All new, not rebuilt. Precision welded and balanced. Includes new ring gear.

Year	Description	Part No.	List
64-72	C-4, 157 teeth, 289, 302	C3AZ-6375-L	\$51.95 ^{EA}
67-70	C-6, 184 teeth, 390	C7AZ-6375-B	\$69.95 ^{EA}
68-70	428, non SCJ	C8AZ-6375-C	\$118.95 ^{EA}
68-73	C-4 and FMX, 164 teeth, 302, 351W	C9AZ-6375-A	\$61.95 ^{EA}

AUTOMATIC TRANSMISSION SPACER PLATE



Stamped steel spacer plate goes between engine and bell housing. Some early 302's were 157T.

Year	Description	Part No.	List
65-68	C-4, 289, 6 bolt, 157T	C5ZZ-7007/7986	\$52.95 ^{PR}
68-73	C-4, 302, 351 164T	C9DZ-7007/7986	\$44.00 ^{PR}

AUTOMATIC TRANSMISSION SPACER PLATE



A nice reproduction of a commonly missing part. Helps keep dirt and debris out of the bell housing.

Year	Description	Part No.	List
64-73	C-4, zinc	C5DZ-7986-B	\$10.95 ^{EA}
64-73	C-4, chrome	C5DZ-7986-C	\$14.95 ^{EA}
66-70	C-6, black	C6AZ-7986-A	\$36.95 ^{EA}

BACKING PLATE AXLE GASKET



Authentic reproduction gasket.

Year	Description	Part No.	List
64-73	Inner	C5ZZ-1001-I	\$4.95 ^{EA}
64-73	Outer	C5ZZ-1001-O	\$4.95 ^{EA}

**WE PROUDLY FEATURE AUTHENTIC MUSTANG
REPRODUCTIONS FROM SCOTT DRAKE!**



REAR WHEEL BEARING

High quality part made in the U.S.A. See "Wheel" section for all bearings.

Year	Description	Part No.	List
64-73	V8, 8 & 9" rear end, 28 spline	CSZZ-1225-A	\$35.95 ^{EA}
65-70	6 cyl., 24 spline	CSZZ-1225-B	\$35.95 ^{EA}

DIFFERENTIAL REBUILD KIT

Includes crush sleeve, pinion depth shims, pinion seal, gasket, pinion nut, ring gear bolts, carrier side shims, rear pinion bearing and race, front pinion bearing, and race, carrier bearings and races.



C5ZZ-4141-RK
64-73: 8" rear end

List
\$124.95^{KI}



C7ZZ-4141-RKO28
65-73: 9", 28 spline, non traction lock

List
\$154.95^{KT}

REAR AXLE SEAL

High quality part made in the U.S.A.

Year	Description	Part No.	List
64-66	8 Cylinder, 28 Spline, 8" Rear End	CSZZ-1177-A	\$26.95 ^{EA}
64-66	6 Cylinder	CSZZ-1177-B	\$24.95 ^{EA}
64-66	31 Spline, 9" Rear End	CSZZ-1177-C	\$9.95 ^{EA}
67-73	8 Cylinder, 28 Spline, 8" Rear End	C7ZZ-1177-A	\$16.95 ^{EA}
67-73	6 Cylinder, 28 Spline, 8" Rear End	C7ZZ-1177-B	\$23.95 ^{EA}

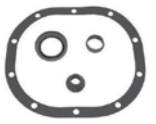
DIFFERENTIAL SEAL KIT

Includes crush sleeve, pinion depth shims, pinion seal and gasket. 9" version pictured. Note: 8" version does not come with actual gasket.

Tube of form-a-gasket included.

Year	Description	Part No.	List
64-73	V8, 8" rear end	CSZZ-4141-SK	\$38.95 ^{KI}
64-73	V8, 9" rear end	C7ZZ-4141-SK	\$38.95 ^{KI}

DIFFERENTIAL GASKET

Stop those driveway spots with a new differential gasket.

Year	Description	Part No.	List
64-73	8"	CSZZ-4035-A	\$8.95 ^{EA}
69-73	9"	E3TZ-4035-B	\$6.95 ^{EA}

REAR END VENT HOSE KIT

Rubber hose that allows rear end to breath. Runs from brake junction block up to body. Includes attaching hardware.

Year	Part No.	List
64-70	MVH001	\$9.95 ^{KI}

DRIVELINE SAFETY LOOP

Mounts at seat belt holes to eliminate the need for drilling or welding. Prevents drive shaft from dropping to ground when u-joints fail. A must for all high performance vehicles.

Year	Part No.	List
64-73	CSZZ-4602-L	\$15.00 ^{EA}

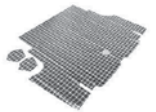
TRUNK**STANDARD DUTY TRUNK MAT**

These precision cut mats are manufactured in the U.S. using the most correct material available. They fit perfectly. In addition, they are printed with the correct plaid or speckle print. Felt backed.

Year	Description	Part No.	List
65-66	CP & CV, plaid	TM-FM-CPCV-65P	\$27.95 ^{EA}
65-66	CP & CV, speckled	TM-FM-CPCV-65-S	\$28.95 ^{EA}
67-68	CP & CV, plaid	TM-FM-CPCV-67P	\$27.95 ^{EA}
67-68	CP & CV, speckled	TM-FM-CPCV-67-S	\$28.95 ^{EA}
69-70	CP & CV, plaid	TM-FM-CPCV-69P	\$27.95 ^{EA}
69-70	CP & CV, speckled	TM-FM-CPCV-69-S	\$28.95 ^{EA}
71-73	CP & CV, plaid	TM-FM-CPCV-71P	\$27.95 ^{EA}
71-73	CP & CV, speckled	TM-FM-CPCV-71-S	\$28.95 ^{EA}
65-66	FB, plaid	TM-FM-FB-65-P	\$27.95 ^{EA}
65-66	FB, speckled	TM-FM-FB-65-S	\$28.95 ^{EA}
67-68	FB, plaid	TM-FM-FB-67-P	\$27.95 ^{EA}
67-68	FB, speckled	TM-FM-FB-67-S	\$28.95 ^{EA}
69-70	FB, plaid	TM-FM-FB-69-P	\$27.95 ^{EA}
69-70	FB, speckled	TM-FM-FB-69-S	\$28.95 ^{EA}
71-73	FB, plaid	TM-FM-FB-71-P	\$27.95 ^{EA}
71-73	FB, speckled	TM-FM-FB-71-S	\$28.95 ^{EA}

STANDARD DUTY SPARE TIRE COVER

Available in Plaid or Speckled patterns. Sewn vinyl construction.

Year	Description	Part No.	List
64-73	Black, 14"	TC-BLK-14V	\$19.95 ^{EA}
64-73	Black, 15"	TC-BLK-15V	\$19.95 ^{EA}
69-73	Space saver, black	TC-BLK-SS	\$19.95 ^{EA}
64-73	Plaid, 13"	TC-PLD-13V	\$19.95 ^{EA}
64-73	Plaid, 14"	TC-PLD-14V	\$19.95 ^{EA}
64-73	Plaid, 15"	TC-PLD-15V	\$19.95 ^{EA}
64-73	Speckled, 13"	TC-SPK-13V	\$20.95 ^{EA}
64-73	Speckled, 14"	TC-SPK-14V	\$20.95 ^{EA}
64-73	Speckled, 15"	TC-SPK-14V	\$20.95 ^{EA}

HEAVY DUTY SPARE TIRE COVER

Available in Plaid or Speckled patterns. Specially manufactured to match patterns on the "Heavy Duty Trunk Mat". Thick vinyl construction.

Year	Description	Part No.	List
64-70	Plaid, 14"	TC-PLD-14	\$44.95 ^{EA}
64-70	Plaid, 15"	TC-PLD-15	\$44.95 ^{EA}
64-70	Speckled, 14"	TC-SPK-14	\$44.95 ^{EA}
64-70	Speckled, 15"	TC-SPK-15	\$44.95 ^{EA}

HEAVY DUTY TRUNK MAT

Incredibly tough rubber-like mats made to our specifications. Just like the original Ford mats. Much more durable than felt-backed vinyl mats. Formed to fit trunk floor. Fits coupes and convertibles with no trimming. Fastback installations require slight trimming.

Year	Description	Part No.	List
64-66	Plaid	CSZZ-6545456CAB	\$75.95 ^{EA}
65-68	Plaid	C7ZZ-6545456CAB	\$75.95 ^{EA}
69-70	Speckled	C9ZZ-6545456CAB	\$85.95 ^{EA}
71-73	Plaid, heavy duty	D1ZZ-6545456CAB	\$75.95 ^{EA}

JACK BAG

Organized way to keep the jack clean and help reduce quarter panel damage from jack hitting the interior.

Year	Description	Part No.	List
64-73	Black	JB-FM-BK	\$8.95 ^{EA}
64-73	Plaid (matches standard duty)	JB-FM-PLD	\$8.95 ^{EA}
64-73	Speckled	JB-FM-SPK	\$8.95 ^{EA}
64-70	Plaid, matches heavy duty	JB-PLD-HD	\$13.95 ^{EA}

BURTEX TRUNK MAT



Original type construction Burtex. We found the best Burtex manufacturer in the country. Excellent fit. Order our Heavy Duty Tire Covers for best match.

Year	Description	Part No.	List
65-67	Fastback, speckled	C5ZZ-6345456-B	\$149. ⁹⁵ EA
64-68	Coupe & Convertible, speckled	C5ZZ-6545456-B	\$149. ⁹⁵ EA
67	Fastback, plaid	C7ZZ-6345456-B	\$149. ⁹⁵ EA
67	Coupe & Convertible, plaid	C7ZZ-6545456-B	\$149. ⁹⁵ EA
68	Fastback, speckled	C8ZZ-6345456-B	\$149. ⁹⁵ EA
69-70	Coupe & Convertible, speckled	C9ZZ-6545456-B	\$149. ⁹⁵ EA
69-70	Fastback, speckled	C9ZZ-6345456-B	\$149. ⁹⁵ EA
71-73	Fastback, speckled	D1ZZ-6345456-B	\$149. ⁹⁵ EA

LARGE TOTE BAG



Heavy duty vinyl sewn storage bag. Carry handles with large zipper opening. Available in all Black, Plaid or Speckled. Matches standard duty. Large tote bags are 21"x9"x9". Also available four Cougar and Falcon.



Year	Description	Part No.	List
64-73	Black, w/ emblem	TB-FM-BK-E*	\$26. ⁹⁵ EA
64-73	Black, no emblem	TB-L-BK-NE	\$26. ⁹⁵ EA
64-73	Plaid, w/ emblem	TB-FM-L-PLD*	\$26. ⁹⁵ EA
64-73	Plaid, no emblem	TB-L-PLD-NE	\$26. ⁹⁵ EA
64-73	Speckled, w/ emblem	TB-FM-L-SPK*	\$26. ⁹⁵ EA
64-73	Speckled, no emblem	TB-L-SPK-NE	\$26. ⁹⁵ EA

SMALL TOTE BAG



There is a full line of Trunk accessories to match our trunk mats. All made with the same high quality material in the U.S. Check out our tire covers, tote bags and booster cable bag. Small tote bags are 17"x8"x8". Also available four Cougar and Falcon.



Year	Description	Part No.	List
64-73	Black, w/ emblem	TB-FM-BK-ES*	\$22. ⁹⁵ EA
64-73	Black, no emblem	TB-S-BK-NE	\$22. ⁹⁵ EA
64-73	Plaid, w/ emblem	TB-FM-S-PLD*	\$22. ⁹⁵ EA
64-73	Plaid, no emblem	TB-S-PLD-NE	\$22. ⁹⁵ EA
64-73	Speckled, w/ emblem	TB-FM-S-SPK*	\$22. ⁹⁵ EA
64-73	Speckled, no emblem	TB-S-SPK-NE	\$22. ⁹⁵ EA

TOOL KIT BAG



Vinyl storage for common emergency tools, inside has felt lining. Matches standard duty.

Year	Description	Part No.	List
64-73	Plaid	TK-FM-PLD	\$12. ⁹⁵ EA
64-73	Speckled	TK-FM-SPK	\$12. ⁹⁵ EA

CONVERTIBLE TOP BOOT BAG



Large envelope used to hold top boot, helps keep boot clean and damage free. Matches standard duty.

Year	Description	Part No.	List
64-73	Black	BB-FM-BK	\$14. ⁹⁵ EA
64-73	Plaid	BB-FM-PLD	\$14. ⁹⁵ EA
64-73	Speckled	BB-FM-SPK	\$14. ⁹⁵ EA

JUMPER CABLE BAG



Nice storage device to hold jumper cables, protects cables and trunk interior. Matches standard duty.

Part No.	Year	Description	List
BC-BK	64-73	Black	\$19. ⁹⁵ EA
BC-PLD	64-73	Plaid	\$19. ⁹⁵ EA
BC-SPK	64-73	Speckled	\$19. ⁹⁵ EA

TRUNK CARPET KIT



This kit includes everything to carpet the entire trunk area and is made of 100% nylon. All edges are bound to keep the carpet from fraying. The side panels are made with fiberboard to make a clean professional installation.

Year	Description	Part No.	List
65-66	Coupe, black	TMK-CP-65-BK	\$249. ⁹⁵ KT
67-68	Coupe, black	TMK-CP-67-BK	\$249. ⁹⁵ KT
65-66	Fastback, black	TMK-FB-65-BK	\$249. ⁹⁵ KT
67-68	Fastback, black	TMK-FB-67-BK	\$249. ⁹⁵ KT
70	Fastback, black	TMK-FB-70-BK	\$249. ⁹⁵ KT

TRUNK UNDERLAYMENT



Installs over fuel tank and under trunk mat. Helps to reduce trunk noise and protect top of fuel tank. Thick rubber material.

Year	Description	Part No.	List
65-68	Trunk	UL-5	\$16. ⁹⁵ EA

TRUNK FILLER BOARD



Mounts in left side of trunk to cover the hole between the quarter panel skin and the trunk floor. Made of heavy duty fiberboard or black chipboard.

Year	Description	Part No.	List
64-66	Fiber board	C5ZZ-6511228-A	\$5. ⁹⁵ EA
67-68	Black chipboard	C7ZZ-6511228-A	\$6. ²⁵ EA
69-70	Black chipboard	C9ZZ-6511228-A	\$7. ⁵⁰ EA

TRUNK FILLER BOARD SCREWS



Concours correct. Zinc plated.

Year	Part No.	List
64-67	379120-S	\$4. ²⁵ PR

REAR SEAT DIVIDER



Separates the interior from the trunk space. Mounts behind the rear seat back rest. Reduces noise and insulates the interior from trunk heat.

Year	Description	Part No.	List
64-66	Coupe and Convertible	C5ZZ-6545728	\$18. ⁹⁵ EA
67-68	Coupe, gray felt	C7ZZ-6545728	\$34. ⁹⁵ EA
67-68	Convertible	C7ZZ-7645728	\$16. ⁹⁵ EA

TAIL LIGHT FILLER BOARD

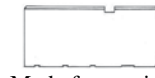

Fits into the trunk compartment and protects the tail lamp housings. Made from original type black oil paper board.

Part No.	Year	Description	List
S8MS-65403A25-A	68	Shelby and California Special	\$20. ⁹⁵ PR
S9MS-65403A25-A	69-70	Shelby	\$20. ⁹⁵ PR

SPARE TIRE MOUNTING KIT

Complete hardware kit to replace the factory mounting pieces. Includes correct cadmium plated wing nut, zinc plated mounting bolt, and painted hold-down plate with correct tabs. Exact reproductions of the originals.



64-65: Carriage bolt
C4ZZ-14244862-K

List

\$8.⁹⁵ KI



65-67: Hook bolt
C5ZZ-14244862-K

List

\$8.⁹⁵ KI

WE PROUDLY FEATURE AUTHENTIC MUSTANG REPRODUCTIONS FROM SCOTT DRAKE!



SPARE TIRE HOLD DOWN PLATE



Mounting plate to hold your spare securely.

Year	Description	Part No.	List
64-67	Black, standard wheels	CSZZ-1424-A	\$3.95 ^{EA}
64-67	Black, styled steel wheels	CSZZ-1424-B	\$7.50 ^{EA}
64-67	Chrome, styled steel wheels	CSZZ-1424-C	\$8.95 ^{EA}

SPARE TIRE WING NUT



Spare tire wingnut. Nice copies of the originals. Zinc plated like originals for extra corrosion protection.

Year	Desc	Part No.	List
64-67	Zinc	B9AZ-1462-A	\$3.95 ^{EA}
68-73	Zinc	C8AZ-1462-B	\$3.95 ^{EA}

SPARE TIRE MOUNTING BOLT

Exact copies of the bolts used by Ford. Zinc plated.



64-65: Carriage bolt
CSZZ-1448-B

List
\$2.50 ^{EA}



65-67: Hook bolt
C60Z-1448-A

List
\$3.95 ^{EA}



69-73: Hook bolt, 1/2" - 13 x 10 3/4"
C9ZZ-1448-B

List
\$12.00 ^{EA}

SPARE TIRE JACK PAD

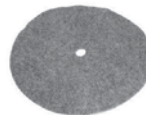

This extra thick felt pad protects rim from scratches and eliminates rattles caused by the jack.

Year	Part No.	List
69-73	C9ZZ-17A092-A	\$14.95 ^{EA}

SPACE SAVER MOUNTING BRACKET



Kit that allows mounting a space saver tire in the trunk.

Year	Part No.	List
69-70	C9ZZ-1424-K	\$74.95 ^{KI}

GLOVE BOX AND TRUNK LOCK



This kit allows the use of one key for the glovebox and trunk lock. Original Ford option.

Year	Part No.	List
67-68	C6DZ-6506072-K	\$34.95 ^{SE}
69-70	C9ZZ-6506072-K	\$34.95 ^{SE}

TRUNK LATCH STRIKER



Exact detail made from heavy gauge steel. 65-66 available in silver zinc or bright chrome. 67-70 painted black.

Year	Description	Part No.	List
64-66	Zinc	C40B-6243252	\$10.95 ^{EA}
64-66	Chrome	C40B-6243252-C	\$12.95 ^{EA}
67-68	Black	C7ZZ-6243252	\$14.95 ^{EA}
69-70	Black	C9ZZ-6243252	\$14.95 ^{EA}

TRUNK LATCH



Heavy duty steel stamped construction with a bright zinc plated finish.

Year	Part No.	List
64-66	C20Z-6243200-B	\$34.95 ^{EA}
67-73	C5AZ-6243200-A	\$42.95 ^{EA}

TRUNK RELEASE



High quality chrome with improved cable. Includes chrome base, lever cable, and all mounting hardware. (Note: 67-70

release only works on cars that come factory equipped with this option. All others refer to electronic version)

Year	Description	Part No.	List
64-66	All	C4AZ-62432A00-A	\$54.95 ^{KI}
67-70	Manual remote	C7AZ-62432A00-A	\$54.95 ^{KI}

ELECTRONIC TRUNK RELEASE



We combined the classic look of the original remote trunk release with a chrome release lever and a strong electric

solenoid driven latch with a modern micro switch release. Now, with a light finger pull the trunk lid opens. No cables to stretch or corrode. Simple 30 minute installation with no modifications to the car. All mounting hardware and connectors are included. Fits Coupe, Fastback and Convertible.

Part No.	Year	List
C5AZ-6243200-EL	64-66	\$99.95 ^{KI}
C7AZ-6243200-EL	67-70	\$99.95 ^{KI}

WIRELESS TRUNK RELEASE



This kit is an upgrade to our Electronic Trunk Release. Kit includes two wireless remotes that open your trunk with the push

of a button. Check for availability.

Part No.	Year	List
C5Z-6243200-WR	65-70	\$49.95 ^{KI}

TRUNK LID PROP ROD



Our steel prop rod is zinc plated for years of service. We include the storage clip and the retaining clip for a

quick and complete installation. A must when using a rear spoiler.

Year	Part No.	List
69-70	C9ZZ-6344206	\$29.95 ^{SE}

FEATURED ITEM

FIRE EXTINGUISHER & LIGHT MOUNT



NHRA approved, the Drake fire extinguisher mount is machined from 6061-T6 billet aluminum with a black anodized finish and laser etched logo. Features also include a red anodized quick release knob and versatile mounting options. Year various sizes of automobile fire extinguishers



This universal Flash Light Mount is machined from 6061-T6 billet aluminum with a black anodized finish to match our

popular Fire Extinguisher Mount part # FIREX-MNT-DAG. Features include a red anodized quick release knob and versatile mounting options. This mount has been engineered to accept the most popular Flashlights.

Description	Part No.	List
Mount	LIGHT-MNT-DOR	\$64.95 ^{EA}

FIRE EXTINGUISHER MOUNT CLAMPS



Heavy Duty T-Bar style band clamps. Each set comes with 4 clamps: 2 for securing your fire extinguisher to our Drake

Fire Extinguisher Mount (FIREX-MNT-DAG), and 2 for securing the mount to a roll bar in your vehicle. These clamps fit MaxOut fire extinguishers (MX100R or MX250R).

Description	Part No.	List
Large	FIRE-CLMP-L-DAG	\$18.95 ^{SE}
Small	FIRE-CLMP-S-DAG	\$18.95 ^{SE}

*Clamps sold separately (below). Fire Extinguisher not included.

FEATURED ITEM

WHEELS



Wheels



Charcoal / Machined Finish

LEGENDARY STYLED ALLOY WHEELS

Inspired by the timeless classic look of the original styled steel wheel - this fresh cast aluminum design establishes the new standard of classic Mustang styling. With a bold 5 spoke composition, precision machined details and a deep stepped lip - the new Styled Alloy wheel will compliment your car and turn heads on the street. Finish the look of your dream car with one of 11 different die-cast center cap designs. Center caps and lugnuts sold separately.



Size	Bolt Pattern	Backspace	Finish	Part No.	List
15" x 7"	5x4.5	4.25	Charcoal / Machined	LW20-50754B	\$169. ⁹⁵ EA
16" x 8"	5x4.5	4.5	Charcoal / Machined	LW20-60854B	\$169. ⁹⁵ EA

WE PROUDLY FEATURE AUTHENTIC MUSTANG REPRODUCTIONS FROM SCOTT DRAKE!





LEGENDARY MAGNUM 500 ALLOY WHEEL

The Legendary Magnum 500 alloy wheel is the ultimate expression of the nostalgic muscle car attitude. This iconic design is enhanced with precision aluminum alloy construction and CNC machined details for a show winning look. Available in 15" x 7" and 16" x 8" with a gloss black and machined finish for a more traditional look or a satin finish for that custom hot rod look. Center caps and lugnuts sold separately.



Gloss Black / Machined Finish

Satin Black / Satin Finish



Wheels shown with center cap LW-HC004 (sold separately)

Size	Bolt Pattern	Backspace	Finish	Part No.	List
15" x 7"	5 x 4.5	4.25	Gloss Black / Machined	LW50-50754A	\$169.95 EA
16" x 8"	5 x 4.5	4.5	Gloss Black / Machined	LW50-60854A	\$179.95 EA
15" x 7"	5 x 4.5	4.25	Satin Black / Satin	LW50-50754D	\$169.95 EA
16" x 8"	5 x 4.5	4.5	Satin Black / Satin	LW50-60854D	\$179.95 EA

LEGENDARY MAGNUM 400 ALLOY WHEEL

Finally and attractive performance oriented Wheel for Classic Fords with 4 Lug Bolt Pattern. This 15 x 6" Magnum 400 Rim allows you to run larger diameter 15" Tires which gives you multiple performance tire choices not available in 14" Tires anymore. Our practical 6" width allows you to run wider tires than stock but help eliminate the clearance issues associated with wider 7" Rims on these cars where most were originally equipped with 14 x 5" rims.

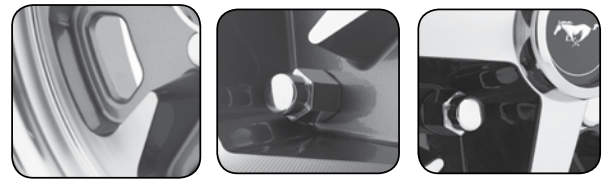

Wheels shown with center cap LW-HC004 (sold separately)

Size	Bolt Pattern	Backspace	Finish	Part No.	List
15" x 6"	4 x 4.5	4	Gloss Black / Machined Finish	LW40-50644A	\$164.95 EA
15" x 6"	4 x 4.5	4	Charcoal / Machined Finish	LW40-50644B	\$179.95 EA



Charcoal / Machined Finish

Gloss Black / Machined Finish

SHOW QUALITY DIE-CAST CENTER CAPS

Legendary Wheel Company center caps are die-cast with precision for a perfect fit and a show quality finish. Each emblem is its own work of art with unparalleled detail and correct accent colors. They utilize an easy to install mounting system designed to work exclusively on Legendary wheels that eliminates the risk of caps being lost or stolen. Legendary caps are interchangeable and will work on all Legendary Wheels.

NOTE: Will not work on steel wheels.



Red Mustang
LW-HC001



Black Mustang
LW-HC002



Blue Mustang
LW-HC003



Black Pony / Satin Bezel
LW-HC004-F



Black Pony / Chrome Bezel
LW-HC004



Red Ford Crown
LW-HC006



Black Ford Crown
LW-HC007



Blue Cougar
LW-HC010



Black Cougar
LW-HC011



Mercury
LW-HC008



GT-350
LW-HC005

Description	Part No.	List
Red Mustang Tri-bar	LW-HC001	\$24. ⁹⁵ EA
Black Mustang Tri-bar	LW-HC002	\$24. ⁹⁵ EA
Blue Mustang Tri-bar	LW-HC003	\$24. ⁹⁵ EA
Black Pony / Chrome Bezel	LW-HC004	\$29. ⁹⁵ EA
Black Pony Satin Bezel	LW-HC004-F	\$29. ⁹⁵ EA
GT-350	LW-HC005	\$34. ⁹⁵ EA
Red Ford Crown	LW-HC006	\$34. ⁹⁵ EA
Black Ford Crown	LW-HC007	\$34. ⁹⁵ EA
Mercury	LW-HC008	\$34. ⁹⁵ EA
Blue Cougar	LW-HC010	\$34. ⁹⁵ EA
Black Cougar	LW-HC011	\$34. ⁹⁵ EA

Description	Part No.	List
Chrome Lug Nut - E/T Conical, 1/2", 13/16" Hex	LW-LN002	\$1. ⁹⁵ EA
Installation Kit 5-lug, 1/2" w/ Valve Stems	LW-LN002-20	\$39. ⁹⁵ EA
Chrome Lug Nut - E/T Conical, 1/2", 3/4" Hex	LW-LN003	\$1. ⁹⁵ EA



Wheel Installation Kit
LW-LN002-20



Chrome Lug Nut 1/2"
LW-LN002



Alloy Wheel 3/4" Hex
Chrome Lug Nut 1/2"
LW-LN003



**WE PROUDLY FEATURE AUTHENTIC MUSTANG
REPRODUCTIONS FROM SCOTT DRAKE!**



STYLED STEEL WHEELS

Great Precise assembly to ensure a true and balanceable rim • Triple chrome plating • Attractive and informative double-wall shipping boxes • Correct charcoal painted recesses baked • on for durability • Simulated rivets on stock sizes for concours judging • Correct clearance for original 1965-67 4-piston disc brake calipers.

Year	Description	Part No.	List
65	14" x 5", chrome, charcoal inserts	CSZZ-1007-A	\$169. ⁹⁵ EA
64	14" x 5", chrome, argent inserts	CSZZ-1007-ARG	\$169. ⁹⁵ EA
65-67	14" x 6", chrome	CSZZ-1007-D	\$174. ⁹⁵ EA
65-67	14" x 7", chrome	CSZZ-1007-B	\$174. ⁹⁵ EA
65-67	15" x 7", chrome	CSZZ-1007-C	\$184. ⁹⁵ EA
66	14" x 5", black rim	C6ZZ-1007-A	\$169. ⁹⁵ EA
67	14" x 5 1/2", black rim	C7ZZ-1007-A	\$169. ⁹⁵ EA

WHEEL BEAUTY RING

Great reproductions of the original parts. Polished stainless steel. Original style beauty ring.

Part No.	Year	Description	List
C6ZZ-1210-AR	66		\$29. ⁹⁵ EA
C6ZZ-1210-AS	66	Set of 4	\$118. ⁹⁵ SE
C7ZZ-1210-AR	67		\$29. ⁹⁵ EA
C7ZZ-1210-AS	67	Set of 4	\$118. ⁹⁵ SE

SHORT CHROME VALVE STEMS

These Valve Stems make a great compliment to our Styled Steel Wheels. Look much better than tall black rubber ones used by tire shops. Also fits 68-69 Style Steel Wheels and Magnums. Not for use with beauty rings.

Part No.	Year	Description	List
ACC-CVS	64-73	Set of 4	\$5. ⁹⁵ SE

VALVE STEM CAPS

Chrome hex shaped valve stem caps with various logos.



Year	Description	Part No.	List
64-73	Tiffany	ACC-5030181	\$17. ⁹⁵ EA
64-73	GT	ACC-5030670	\$17. ⁹⁵ EA
64-73	Cobra	ACC-5033205	\$17. ⁹⁵ EA
64-73	Blue oval logo	ACC-5033260	\$17. ⁹⁵ EA
64-73	Tri-bar	ACC-5033270	\$17. ⁹⁵ EA

STYLED STEEL HUB CAPS

Scott Drake Mustang Hub Caps feature show-quality chrome plating, perfectly detailed lenses, and correct accent colored backgrounds. Our new and improved retaining system now makes them easier to install and prevents them from falling off or being stolen. These are the finest reproductions on the market at very competitive prices. Choose original colors: Red for 64-66 and blue for 67, or customize your car with a color better suited for your Mustang. NOTE: Will not work on Legendary alloy wheels.

Year	Description	Part No.	List
65-66	Red	CSZZ-1130-W	\$24. ⁹⁵ EA
65-66	Red, set of 4	CSZZ-1130-WR	\$99. ⁹⁵ SE



Year	Description	Part No.	List
65-66	Black	CSZZ-1130-BK	\$24. ⁹⁵ EA
65-66	Black, set of 4	CSZZ-1130-WB	\$99. ⁹⁵ SE



Year	Description	Part No.	List
65-66	Blue	CSZZ-1130-BL	\$24. ⁹⁵ EA
65-66	Blue, set of 4	CSZZ-1130-WBL	\$99. ⁹⁵ SE

STYLED STEEL HUB CAPS

Year	Description	Part No.	List
67	Blue	C7ZZ-1130-A	\$31. ⁹⁵ EA
67	Blue, set of 4	C7ZZ-1130-AK	\$127. ⁹⁵ SE



Year	Description	Part No.	List
67	Black	C7ZZ-1130-A	\$31. ⁹⁵ EA
67	Black, set of 4	C7ZZ-1130-AK	\$127. ⁹⁵ SE



Year	Description	Part No.	List
67	Red	C7ZZ-1130-R	\$31. ⁹⁵ EA
67	Red, set of 4	C7ZZ-1130-RK	\$127. ⁹⁵ SE



Description	Part No.	List
Red, Falcon/Fairlane	C6BZ-1130-S	\$34. ⁹⁵ EA
Red, Falcon/Fairlane Set of 4	C6BZ-1130-W	\$139. ⁹⁵ SE



Description	Part No.	List
Black, Falcon/Fairlane	C6BZ-1130-BK	\$34. ⁹⁵ EA
Black, Falcon/Fairlane Set of 4	C6BZ-1130-BK4	\$139. ⁹⁵ SE

STYLED STEEL WHEEL COVER

Gives the illusion of real styled steel wheels at one third of the price. Constructed from heavy duty A.B.S. plastic. Also features correct charcoal painted recessed area's and chrome simulated lugnuts. Now even 6 cylinders can have an 8 cylinder look. Center cap not included.

Year	Description	Part No.	List
65-67	14"	CSZZ-1007-HC	\$39. ⁹⁵ EA
64-67	14", set of 4	CSZZ-1007-HCS	\$134. ⁹⁵ SE

STYLED STEEL WHEEL COVER HUB CAP

These caps are gorgeous. Designed to fit our plastic styled steel wheel covers.

Year	Description	Part No.	List
64-66	Black, set of 4	CSZZ-1130-BKL	\$99. ⁹⁵ SE
65-66	Red, each	CSZZ-1130-WL	\$24. ⁹⁵ EA

MAGNUM 500 WHEEL



Does not include center cap. Beautiful chrome plating. Concours correct hubcap & lugnuts sold separately.

Year	Description	Part No.	List
69-73	14" x 7", 2 1/8" center hole	D1ZZ-1007-B	\$189. ⁹⁵ EA
69-73	15" x 7", 2 1/8" center hole	D1ZZ-1007-A	\$189. ⁹⁵ EA
69-73	15" x 8", 2 1/8" center hole	D1ZZ-1007-C	\$199. ⁹⁵ EA
69	15" x 7", 2" center hole	C9ZZ-1007-B	\$199. ⁹⁵ EA

MAGNUM HUB CAPS



These beautiful hub caps feature our high quality chrome bezels. Designed to fit Steel Magnum 500 wheels. Improved anti-theft retainers! **NOTE:**

Will not work on Legendary alloy wheels.



Year	Description	Part No.	List
69	Fits 2" center hole	C9ZZ-1130-E	\$34. ⁹⁵ EA
69-70	2 1/8" hole, 0.66" tall	D0ZZ-1130-A	\$32. ⁹⁵ EA
71-73	Fits 2 1/8" hole, 1" tall	D1ZZ-1130-GR	\$29. ⁹⁵ EA



These New from Scott Drake is our Magnum 500 Hub Cap in black. This beautiful part features a show quality chrome plated

zinc die cast hub cap with our very detailed Ford Crest emblem. This cap is designed to work with Magnum 500 Wheels with 2 1/8th center holes. Great hub cap alternative for other Ford cars using Magnum 500 wheels



Year	Description	Part No.	List
69-73	Black 2 1/8" hole, 0.66" tall	C9OZ-1130-BLACK	\$32. ⁹⁵ EA
69-73	Red 2 1/8" hole, 0.66" tall	C9OZ-1130-RED	\$32. ⁹⁵ EA



69-73: Spinner (fits Magnum Wheels)
D1ZZ-1141-A

List
\$129.⁹⁵ SE



65-66: G.T.350 cobra logo (fits Magnum wheels)
S2MS-1130-B



List
\$34.⁹⁵ EA

1968-69 STYLED STEEL WHEEL



These wheels were standard equipment on GT's and Mach 1's but were also a commonly ordered option for many cars. Originally

they were 14x6 with a beauty ring. We also offer with a chrome rim as well as larger sizes.

Year	Description	Part No.	List
68-69	14" x 6", black rim	C8OZ-1007-A	\$179. ⁹⁵ EA
68-69	14" x 6", all chrome	C8OZ-1007-B	\$179. ⁹⁵ EA
68-69	14" x 7", all chrome	C8OZ-1007-C	\$184. ⁹⁵ EA
68-69	15" x 7", all chrome	C8OZ-1007-D	\$189. ⁹⁵ EA

68-69 STYLED STEEL HUBCAP



68-69: GT
C8OZ-1130-C

List
\$32.⁹⁵ EA



68-69: Plain, no logo
C8OZ-1130-G

List
\$29.⁹⁵ EA

1968-69 STYLED STEEL HUB CAP

EMBLEM



68-69: GT
C8OZ-1141-A

List
\$15.⁹⁵ EA

1968-69 STYLED STEEL WHEEL

ACCENT



Features include a bright-chrome finish and simple snap-in installation. These were a rare option offered

by Ford. These wheel accents really dress up argent or body-color painted rims! 50 piece set does 4 wheels.

Year	Part No.	List
68-69	C9ZZ-1A079-A	\$99. ⁹⁵ SE

LUG NUT

Multiple styles of lugnuts are available to finish off the look of your wheels.



64-73: Standard
COAZ-1012-A

List
\$0.⁷⁵ EA



65-67: Styled steel, show quality, chrome
CSZZ-1012-A

List
\$2.⁵⁰ EA



69-73: Magnum 500, Show quality, chrome
C9ZZ-1012-B

List
\$2.⁹⁵ EA

1968-69 STYLED STEEL WHEEL

ACCENT



Protect your expensive rims and tires from theft. Our locks are made to re-assemble factory lugnuts for a cleaner appearance. This kit includes four chrome, keyed lugnuts and matching key.

Year	Part No.	List
64-73	CSZZ-1012-LOCK	\$20. ⁹⁵ SE

LOCKING LUG NUT KIT



Set includes 16 chrome lug nuts, 4 locking chrome lug nuts, key lock and 4 chrome valve stems. These lug nuts match our Classic Wheels (S1MS-1007- part numbers).

Year	Part No.	List
64-73	S1MS-1007-LUGKIT	\$44. ⁹⁵ EA

WHEEL SPACER



Aluminum spacer to off-set custom wheels. This hard to find thin spacer is sometimes required to clear upper control arm when running oversized tires on our style steel rim. Does not require longer studs as recommended with more common 1/4" spacers.

Year	Description	Part No.	List
65-73	1/8" thick	SP601-S	\$5. ⁹⁵ EA

WE PROUDLY FEATURE AUTHENTIC MUSTANG REPRODUCTIONS FROM SCOTT DRAKE!



SHELBY STYLED WHEEL



Shelby 10-Spoke Wheels for early Mustangs! These wheels feature cast and machined-textured surfaces, which provide a beautiful contrast under a clear-coat, protective finish. Aftermarket center caps included.

Year	Description	Part No.	List
65-73	15"x7", original option on 67-68 Shelby's	S7MS-1007-A	\$239. ⁹⁵ EA

SHELBY HUB CAP

Our hub caps feature perfect detail. Attaching hardware included.



66-67: CS logo, fits 10 spoke Shelby wheel
S2MS-1130-C



List
\$19.⁹⁵ EA



67-68: Fits 10 spoke Shelby wheels
S7MS-1130-A



List
\$29.⁹⁵ EA



69-70: Cobra logo (Made from Original Ford Tooling)
S9MS-1130-D



List
\$54.⁹⁵ EA

BILLET HUB CAP



High quality billet to give your Torq Thrust or Vintage wheels a finishing touch. Also available plain with no logo. Hole spacing

on vintage caps is 2-1/16" and on Torq Thrust spacing is 2-1/4".



Year	Description	Part No.	List
64-73	Cobra logo, Torq Thrust D wheel, set of 4	B-1130-COBRA-T	\$139. ⁹⁵ SE
64-73	Cobra logo, vintage wheel, set of 4	B-1130-COBRA-V	\$139. ⁹⁵ SE
64-73	GT logo, Torq Thrust D wheel, set of 4	B-1130-GT-T	\$139. ⁹⁵ SE
64-73	GT logo, vintage wheel, set of 4	B-1130-GTV	\$139. ⁹⁵ SE
64-73	Horse logo, Torq Thrust D wheel, set of 4	B-1130-H-T	\$139. ⁹⁵ SE
64-73	Horse logo, vintage wheel, set of 4	B-1130-HV	\$139. ⁹⁵ SE
64-73	No logo, Torq Thrust D wheel, set of 4	B-1130-P-T	\$99. ⁹⁵ SE
64-73	No logo, vintage wheel, set of 4	B-1130-PV	\$99. ⁹⁵ SE

WHEEL COVER

Center emblem not included. Stock replacement wheelcovers. Can be modified to accept knock off spinners.



C5ZZ-1130-J
65: 14"

List

\$69.⁹⁵ EA



C6ZZ-1130-A
66: 14"

List

\$69.⁹⁵ EA

CLASSIC WHEEL



Scott Drake is proud to offer these licensed reproductions* of this classic 1960's wheel design, at an affordable price. Built with today's modern technology, these

wheels are available in Chrome, Polished or Anthracite and all come with Chrome Logoed Cap. Available in sizes from 15x6 to 17x8. Lug nuts sold separately under part # S1MS-1007-LUGKT which includes 16 Chrome lug nuts, 4 locking Chrome lug Nuts, Key Lock and 4 Chrome Valve Stems. * The wheel designs are registered trade marks of "AMERICAN RACING EQUIPMENT, LLC" Licensed to "REV WHEEL, LLC"

Year	Description	Part No.	List
64-73	Anthracite, 15 x 6, 3.5" Backspace	S1MS-1007-156	\$139. ⁹⁵ EA
64-73	Chrome, 15 x 6, 3.5" Backspace	S1MS-1007-156C	\$219. ⁹⁵ EA
64-73	Polished, 15 x 6, 3.5" Backspace	S1MS-1007-156P	\$158. ⁹⁵ EA
64-73	Anthracite, 15 x 7, 4" Backspace	S1MS-1007-157	\$137. ⁹⁵ EA
64-73	Chrome, 15 x 7, 4" Backspace	S1MS-1007-157C	\$225. ⁹⁵ EA
64-73	Polished, 15 x 7, 4" Backspace	S1MS-1007-157P	\$155. ⁹⁵ EA
64-73	Anthracite, 15 x 8, 4.5" Backspace	S1MS-1007-158	\$143. ⁹⁵ EA
64-73	Chrome, 15 x 8, 4.5" Backspace	S1MS-1007-158C	\$225. ⁹⁵ EA
64-73	Polished, 15 x 8, 4.5" Backspace	S1MS-1007-158P	\$158. ⁹⁵ EA
64-73	Anthracite, 17 x 7, 4" Backspace	S1MS-1007-177	\$157. ⁹⁵ EA
64-73	Chrome, 17 x 7, 4" Backspace	S1MS-1007-177C	\$262. ⁹⁵ EA

Year	Description	Part No.	List
64-73	Polished, 17 x 7, 4" Backspace	S1MS-1007-177P	\$190. ⁹⁵ EA
64-73	Anthracite, 17 x 8, 4.5" Backspace	S1MS-1007-1784	\$160. ⁹⁵ EA
64-73	Anthracite, 17 x 8, 5" Backspace	S1MS-1007-1785	\$160. ⁹⁵ EA
64-73	Chrome, 17 x 8, 4.5" Backspace	S1MS-1007-178C4	\$264. ⁹⁵ EA
64-73	Chrome, 17 x 8, 5" Backspace	S1MS-1007-178C5	\$264. ⁹⁵ EA
64-73	Polished, 17 x 8, 4.5" Backspace	S1MS-1007-178P4	\$200. ⁹⁵ EA
64-73	Polished, 17 x 8, 5" Backspace	S1MS-1007-178P5	\$200. ⁹⁵ EA

WHEEL COVER EMBLEM

Fits our standard wheel covers.



65
C5Z-11C30

List

\$18.⁹⁵ EA



66
C6ZZ-11C30

List

\$18.⁹⁵ EA



1967 WHEEL COVER EMBLEM



Previously unavailable. Exact copy of original to replace this commonly cracked and

faded lens.



Year	Part No.	List
67	C7ZZ-11C30*	\$24. ⁹⁵ EA

KNOCK OFF HUB CAP

Die cast construction with show car chrome.



65
C5Z-1141-A

List

\$44.⁹⁵ KI



66
C6Z-1141-A

List

\$44.⁹⁵ KI

KNOCK OFF HUB CAP EMBLEM

These are the center emblems for our knock off hub caps.



65: Spinner, standard
C5ZZ-1141-E



List

\$24.⁹⁵ EA



66: Spinner, standard
C6ZZ-1141-E



List

\$24.⁹⁵ EA

WIRE SPOKE CENTER CAP



Fits wire spoked wheel covers.

Year	Description	Part No.	List
65-66	Spinner, blue, Ford crest	C5AZ-1141-A*	\$34. ⁹⁵ EA
67-68	Red, Mustang	C7ZZ-1141-E*	\$59. ⁹⁵ EA

WIRE SPOKE WHEEL COVER



Spinner and emblem sold separately. 14" polished stainless steel.

Year	Part No.	List
65-68	C5AZ-1130	\$99. ⁹⁵ EA

BRAKE HUB GREASE CAP



Stamped steel with gold dichromate finish.

Year	Description	Part No.	List
64-69	V8	B5A-1131-A	\$6. ⁹⁵ EA
64-66	6 cyl.	C3DZ-1131-A	\$10. ⁹⁵ EA

FRONT WHEEL BEARING AND RACE



Year	Description	Part No.	List
64-69	Inner, V8	B5A-1201-A	\$16. ⁹⁵ EA
64-69	Outer, V8	B5A-1216-A	\$14. ⁵⁰ EA
64-66	Inner, 6 cyl., drum brakes	C5ZZ-1201-A	\$14. ⁵⁰ EA
64-66	Outer, 6 cyl., drum brakes	C5ZZ-1216-A	\$14. ⁵⁰ EA
70-73	Inner	D0ZZ-1201-A	\$18. ⁹⁵ EA
70-73	Outer	D0ZZ-1216-A	\$16. ⁹⁵ EA

FRONT WHEEL GREASE SEAL



Made in the U.S. to ensure high quality and reliability.

Year	Description	Part No.	List
64-70	V8	B5AZ-1190-A	\$6. ⁵⁰ EA
65-66	6 cyl., drum brakes	C5ZZ-1190-A	\$20. ⁹⁵ EA
69	Boss disc brakes	C9ZZ-1190-A	\$16. ⁹⁵ EA

REAR WHEEL BEARING



Year	Description	Part No.	List
64-73	V8, 8 & 9" rear end, 28 spline	C5ZZ-1225-A	\$35. ⁹⁵ EA
65-70	6 cyl., 24 spline	C5ZZ-1225-B	\$35. ⁹⁵ EA

REAR AXLE WHEEL SEAL



Made in the U.S. to ensure high quality and reliability.

Year	Description	Part No.	List
64-66	V8, 8" rear end, 28 spline	C5ZZ-1177-A	\$26. ⁹⁵ EA
64-66	6 cyl.	C5ZZ-1177-B	\$24. ⁹⁵ EA
65-73	9" rear end, 31 spline	C5ZZ-1177-C	\$9. ⁹⁵ EA
67-73	V8, 8 & 9" rear end, 28 spline	C7ZZ-1177-A	\$16. ⁹⁵ EA

BACKING PLATE AXLE GASKET



Authentic reproduction gasket.

Year	Description	Part No.	List
64-73	Inner	C5ZZ-1001-I	\$4. ⁹⁵ EA
64-73	Outer	C5ZZ-1001-O	\$4. ⁹⁵ EA

WINDOWS

WINDSHIELD GLASS



Nice replacement windshields without Ford logos.

Year	Description	Part No.	List
64-68	All, tinted	C6ZZ-6503100-T	\$174. ⁹⁵ EA
64-68	All, clear	C6ZZ-6503100-C	\$272. ⁹⁵ EA
69-70	Fastback, tinted	C9ZZ-6503100-T	\$199. ⁹⁵ EA

WINDSHIELD STOPS



Special brackets used to properly align and install windshield also prevents windshield from sagging while calking cures.

Year	Description	Part No.	List
69-70	W/mounting hardware	C8AZ-6203012-A	\$9. ⁹⁵ SE

VENT WINDOW GLASS ASSEMBLY



Comes complete with vent window glass, stainless steel frame, pivot, and 1967 handle. Will fit 1968 but comes with 67 handle. See "Door Parts" section for 1964-68 Frames only without glass.

Year	Description	Part No.	List
67	RH, clear	C7ZZ-6521608-CK	\$99. ⁹⁵ EA
67	RH, tinted	C7ZZ-6521608-TK	\$104. ⁹⁵ EA
67	LH, clear	C7ZZ-6521609-CK	\$99. ⁹⁵ EA
67	LH, tinted	C7ZZ-6521609-TK	\$104. ⁹⁵ EA

WE PROUDLY FEATURE AUTHENTIC MUSTANG REPRODUCTIONS FROM SCOTT DRAKE!



WINDOW SEALER



Used to water-proof windshield and rear window. Silicone type sealer is best suited for 69-73 glue in windshields.

Year	Description	Part No.	List
64-73	Non-hardening	CRL-7708	\$9.95 ^{EA}

VENT WINDOW FRAME & DOOR GLASS RUN ASSEMBLY



Complete vent and window assembly. Includes vent frame, vent glass, vent glass frame and pivot assembly, vent seals, and door glass run. 1964-66 version pictured.

Year	Description	Part No.	List
64-66	RH, clear	C5ZZ-65222404CK	\$349.95 ST
64-66	RH, tinted	C5ZZ-65222404TK	\$349.95 ^{EA}
64-66	LH, clear	C5ZZ-65222405CK	\$339.95 ST
64-66	LH, tinted	C5ZZ-65222405TK	\$349.95 ^{EA}
68*	RH, clear	C8ZZ-65222404CK	\$384.95 ^{EA}
68*	RH, tinted	C8ZZ-65222404TK	\$394.95 ^{EA}
68*	LH, clear	C8ZZ-65222405CK	\$384.95 ^{EA}
68*	LH, tinted	C8ZZ-65222405TK	\$394.95 ^{EA}

*68 versions will also fit 1967, but you must change the vent handle to be concours.

VENT GLASS



Vent glass is available in clear, factory green tinted, or a new "smoke" version which resembles a modern black tint. Fits convertible, coupe, and Fastback.

Year	Description	Part No.	List
64-68	RH, clear	C5ZZ-6521412-C	\$55.95 ^{EA}
64-68	RH, smoke	C5ZZ-6521412-S	\$79.95 ^{EA}
64-68	RH, tinted	C5ZZ-6521412-T	\$65.95 ^{EA}
64-68	LH, clear	C5ZZ-6521413-C	\$55.95 ^{EA}
64-68	LH, smoke	C5ZZ-6521413-S	\$79.95 ^{EA}
64-68	LH, tinted	C5ZZ-6521413-T	\$65.95 ^{EA}

DOOR GLASS MOUNT AND TRACK KIT



Everything you need to install the much improved 1970 Bolt in Glass into a 1969 Mustang. Great upgrade over 1969 glue in versions. Requires using a 1970 window Regulator.

Part No.	Year	Description	List
DOZZ-6321410-MK	69-70	Right Hand	\$134.95 ^{KI}
DOZZ-6321411-MK	69-70	Left Hand	\$134.95 ^{KI}

DOOR GLASS



Our door glass is available in clear, factory green tinted, or a new "smoke" version which resembles a modern black tint. Glass only.

Coupe Door Glass

Year	Description	Part No.	List
64-66	RH, clear	C5ZZ-6521410-C	\$221.95 ^{EA}
64-66	RH, tinted	C5ZZ-6521410-T	\$230.95 ^{EA}
64-66	LH, clear	C5ZZ-6521411-C	\$221.95 ^{EA}
64-66	LH, tinted	C5ZZ-6521411-T	\$230.95 ^{EA}
67-68	RH, clear	C7ZZ-6521410-C	\$212.95 ^{EA}
67-68	RH, smoke	C7ZZ-6521410-S	\$230.95 ^{EA}
67-68	RH, tinted	C7ZZ-6521410-T	\$221.95 ^{EA}
67-68	LH, clear	C7ZZ-6521411-C	\$212.95 ^{EA}
67-68	LH, smoke	C7ZZ-6521411-S	\$230.95 ^{EA}
67-68	LH, tinted	C7ZZ-6521411-T	\$221.95 ^{EA}
69	RH, clear	C9ZZ-6521410-C	\$235.95 ^{EA}
69	RH, smoke	C9ZZ-6521410-S	\$255.95 ^{EA}
69	LH, clear	C9ZZ-6521411-C	\$235.95 ^{EA}
69	LH, smoke	C9ZZ-6521411-S	\$255.95 ^{EA}
70	RH, clear	DOZZ-6521410-C	\$248.95 ^{EA}
70	RH, smoke	DOZZ-6521410-S	\$264.95 ^{EA}
70	RH, tinted	DOZZ-6521410-T	\$255.95 ^{EA}
70	LH, clear	DOZZ-6521411-C	\$248.95 ^{EA}
70	LH, smoke	DOZZ-6521411-S	\$264.95 ^{EA}
70	LH, tinted	DOZZ-6521411-T	\$255.95 ^{EA}

Convertible Door Glass

Year	Description	Part No.	List
64-66	RH, clear	C5ZZ-7621410-C	\$259.95 ^{EA}
64-66	RH, smoke	C5ZZ-7621410-S	\$268.95 ^{EA}
64-66	RH, tinted	C5ZZ-7621410-T	\$259.95 ^{EA}
64-66	LH, tinted	C5ZZ-7621411-T	\$259.95 ^{EA}
67-68	RH, clear	C7ZZ-7621410-C	\$255.95 ^{EA}
67-68	RH, smoke	C7ZZ-7621410-S	\$267.95 ^{EA}
67-68	RH, tinted	C7ZZ-7621410-T	\$255.95 ^{EA}
67-68	LH, clear	C7ZZ-7621411-C	\$255.95 ^{EA}
67-68	LH, smoke	C7ZZ-7621411-S	\$267.95 ^{EA}
67-68	LH, tinted	C7ZZ-7621411-T	\$255.95 ^{EA}
70	RH, clear	DOZZ-7621410-C	\$263.95 ^{EA}
70	RH, tinted	DOZZ-7621410-T	\$263.95 ^{EA}
70	LH, clear	DOZZ-7621411-C	\$263.95 ^{EA}
70	LH, tinted	DOZZ-7621411-T	\$263.95 ^{EA}

Fastback Door Glass

Year	Description	Part No.	List
65-66	RH, clear	C5ZZ-6321410-C	\$230.95 ^{EA}
65-66	RH, smoke	C5ZZ-6321410-S	\$240.95 ^{EA}
65-66	RH, tinted	C5ZZ-6321410-T	\$230.95 ^{EA}
65-66	LH, clear	C5ZZ-6321411-C	\$230.95 ^{EA}
65-66	LH, smoke	C5ZZ-6321411-S	\$240.95 ^{EA}
65-66	LH, tinted	C5ZZ-6321411-T	\$230.95 ^{EA}
67-68	RH, smoke	C7ZZ-6321410-S	\$240.95 ^{EA}
67-68	RH, tinted	C7ZZ-6321410-T	\$240.95 ^{EA}
67-68	LH, smoke	C7ZZ-6321411-S	\$240.95 ^{EA}
67-68	LH, tinted	C7ZZ-6321411-T	\$240.95 ^{EA}
69	RH, clear	C9ZZ-6321410-C	\$235.95 ^{EA}
69	RH, tinted	C9ZZ-6321410-T	\$277.95 ^{EA}
69	LH, clear	C9ZZ-6321411-C	\$240.95 ^{EA}
69	LH, smoke	C9ZZ-6321411-S	\$255.95 ^{EA}
69	LH, tinted	C9ZZ-6321411-T	\$277.95 ^{EA}
70	RH, clear	DOZZ-6321410-C	\$254.95 ^{EA}
70	RH, tinted	DOZZ-6321410-T	\$261.95 ^{EA}
70	LH, clear	DOZZ-6321411-C	\$254.95 ^{EA}
70	LH, smoke	DOZZ-6321411-S	\$298.95 ^{EA}
70	LH, tinted	DOZZ-6321411-T	\$261.95 ^{EA}
71-73	RH, clear	D1ZZ-6321410-C	\$245.95 ^{EA}
71-73	RH, smoke	D1ZZ-6321410-S	\$261.95 ^{EA}
71-73	LH, clear	D1ZZ-6321411-C	\$245.95 ^{EA}
71-73	LH, smoke	D1ZZ-6321411-S	\$261.95 ^{EA}
71-73	LH, tinted	D1ZZ-6321411-T	\$254.95 ^{EA}

DOOR GLASS ASSEMBLY



This door glass includes the frame, glass run and mounting bracket. Available in clear glass or factory green tint. For replacement glass only, see windows section.

Year	Description	Part No.	List
67-68	Fastback, LH, clear	C7ZZ-6321410-KL	\$279.95 ^{KT}
67-68	Fastback, RH, clear	C7ZZ-6321410-KR	\$279.95 ^{KT}
67-68	Coupe, LH, clear	C7ZZ-6521410-KL	\$274.95 ^{KT}
67-68	Coupe, RH, clear	C7ZZ-6521410-KR	\$274.95 ^{KT}
67-68	Convertible, LH, clear	C7ZZ-7621410-KL	\$279.95 ^{KT}
67-68	Convertible, RH, clear	C7ZZ-7621410-KR	\$279.95 ^{KT}
67-68	Fastback, LH, tinted	C7ZZ-6321410-TL	\$279.95 ^{KT}
67-68	Fastback, RH, tinted	C7ZZ-6321410-TR	\$279.95 ^{KT}
67-68	Coupe, LH, tinted	C7ZZ-6521410-TL	\$274.95 ^{KT}
67-68	Coupe, RH, tinted	C7ZZ-6521410-TR	\$274.95 ^{KT}
67-68	Convertible, LH, tinted	C7ZZ-7621410-TL	\$279.95 ^{KT}
67-68	Convertible, RH, tinted	C7ZZ-7621410-TR	\$279.95 ^{KT}

DOOR GLASS ASSEMBLY



Our quarter glass is available in clear, factory green tinted, or a new "smoke" version which resembles a modern black tint.

Coupe Quarter Glass

Year	Description	Part No.	List
64-66	RH, clear	CSZZ-6529710-C	\$132. ⁹⁵ EA
64-66	RH, smoke	CSZZ-6529710-S	\$147. ⁹⁵ EA
64-66	RH, tinted	CSZZ-6529710-T	\$142. ⁹⁵ EA
64-66	LH, clear	CSZZ-6529711-C	\$132. ⁹⁵ EA
64-66	LH, smoke	CSZZ-6529711-S	\$147. ⁹⁵ EA
64-66	LH, tinted	CSZZ-6529711-T	\$142. ⁹⁵ EA
67-68	RH, clear	C7ZZ-6529710-C	\$132. ⁹⁵ EA
67-68	RH, tinted	C7ZZ-6529710-T	\$142. ⁹⁵ EA
67-68	LH, clear	C7ZZ-6529711-C	\$132. ⁹⁵ EA
67-68	LH, tinted	C7ZZ-6529711-T	\$142. ⁹⁵ EA
69	RH, clear	C9ZZ-6529710-C	\$191. ⁹⁵ EA
69	RH, smoke	C9ZZ-6529710-S	\$208. ⁹⁵ EA
69	RH, tinted	C9ZZ-6529710-T	\$201. ⁹⁵ EA
69	LH, clear	C9ZZ-6529711-C	\$191. ⁹⁵ EA
69	LH, smoke	C9ZZ-6529711-S	\$208. ⁹⁵ EA
69	LH, tinted	C9ZZ-6529711-T	\$201. ⁹⁵ EA
70	RH, clear	DOZZ-6529710-C	\$191. ⁹⁵ EA
70	RH, smoke	DOZZ-6529710-S	\$208. ⁹⁵ EA
70	RH, tinted	DOZZ-6529710-T	\$221. ⁹⁵ EA
70	LH, clear	DOZZ-6529711-C	\$191. ⁹⁵ EA
70	LH, smoke	DOZZ-6529711-S	\$208. ⁹⁵ EA
70	LH, tinted	DOZZ-6529711-T	\$221. ⁹⁵ EA

Fastback Quarter Glass

Year	Description	Part No.	List
69-70	RH, clear	C9ZZ-6329710-C	\$230. ⁹⁵ EA
69-70	RH, smoked	C9ZZ-6329710-S	\$230. ⁹⁵ EA
69-70	RH, tinted	C9ZZ-6329710-T	\$230. ⁹⁵ EA
69-70	LH, clear	C9ZZ-6329711-C	\$230. ⁹⁵ EA
69-70	LH, smoke	C9ZZ-6329711-S	\$230. ⁹⁵ EA
69-70	LH, tinted	C9ZZ-6329711-T	\$230. ⁹⁵ EA
71-73	RH, clear	D1ZZ-6329710-C	\$220. ⁹⁵ EA
71-73	RH, smoke	D1ZZ-6329710-S	\$220. ⁹⁵ EA
71-73	RH, tinted	D1ZZ-6329710-T	\$220. ⁹⁵ EA
71-73	LH, clear	D1ZZ-6329711-C	\$220. ⁹⁵ EA
71-73	LH, smoke	D1ZZ-6329711-S	\$220. ⁹⁵ EA
71-73	LH, tinted	D1ZZ-6329711-T	\$220. ⁹⁵ EA

FASTBACK QUARTER GLASS FRAME



69-70 Fastback: RH and LH
C9ZZ-63302223

List
\$132.⁹⁵ PR

Convertible Quarter Glass

Year	Description	Part No.	List
64-66	RH, smoke	CSZZ-7629710-S	\$240. ⁹⁵ EA
64-66	RH, tinted	CSZZ-7629710-T	\$234. ⁹⁵ EA
64-66	LH, clear	CSZZ-7629711-C	\$234. ⁹⁵ EA
64-66	LH, smoke	CSZZ-7629711-S	\$240. ⁹⁵ EA
64-66	LH, tinted	CSZZ-7629711-T	\$234. ⁹⁵ EA
67-68	RH, clear	C7ZZ-7629710-C	\$234. ⁹⁵ EA
67-68	RH, smoke	C7ZZ-7629710-S	\$240. ⁹⁵ EA
67-68	RH, tinted	C7ZZ-7629710-T	\$234. ⁹⁵ EA
67-68	LH, clear	C7ZZ-7629711-C	\$234. ⁹⁵ EA
67-68	LH, smoke	C7ZZ-7629711-S	\$240. ⁹⁵ EA
67-68	LH, tinted	C7ZZ-7629711-T	\$234. ⁹⁵ EA
69	RH, clear	C9ZZ-6529710-C	\$191. ⁹⁵ EA
69	RH, smoke	C9ZZ-6529710-S	\$208. ⁹⁵ EA
69	RH, tinted	C9ZZ-6529710-T	\$201. ⁹⁵ EA
69	LH, clear	C9ZZ-6529711-C	\$191. ⁹⁵ EA
69	LH, smoke	C9ZZ-6529711-S	\$208. ⁹⁵ EA
69	LH, tinted	C9ZZ-6529711-T	\$201. ⁹⁵ EA
70	RH, clear	DOZZ-6529710-C	\$191. ⁹⁵ EA
70	RH, smoke	DOZZ-6529710-S	\$208. ⁹⁵ EA
70	RH, tinted	DOZZ-6529710-T	\$221. ⁹⁵ EA
70	LH, clear	DOZZ-6529711-C	\$191. ⁹⁵ EA
70	LH, smoke	DOZZ-6529711-S	\$208. ⁹⁵ EA
70	LH, tinted	DOZZ-6529711-T	\$221. ⁹⁵ EA

COUPE QUARTER GLASS

ASSEMBLY



Complete quarter window assembly for Mustang Coupes. Includes chrome plated die-cast frame, glass, seal and rollers.

Year	Description	Part No.	List
64-66	RH, clear	CSZZ-6529958-CK	\$329. ⁹⁵ EA
64-66	RH, tinted	CSZZ-6529958-TK	\$334. ⁹⁵ EA
64-66	LH, clear	CSZZ-6529959-CK	\$329. ⁹⁵ EA
64-66	LH, tinted	CSZZ-6529959-TK	\$334. ⁹⁵ EA

Convertible Back Glass GLASS CONVERTIBLE TOP REAR WINDOW



Glass rear windows greatly enhance rear visibility. They are not prone to scratching, cracking or yellowing due to exposure to the sun.

Year	Description	Part No.	List
64-66	Black	CSZZ-7652500-GB	\$209. ⁹⁵ EA
64-66	White	CSZZ-7652500-GW	\$209. ⁹⁵ EA
67-70	Black	C7ZZ-7652500-GB	\$209. ⁹⁵ EA
67-70	White	C7ZZ-7652500-GW	\$209. ⁹⁵ EA
69-70	White	C9ZZ-7652500-GW	\$199. ⁹⁵ EA
71-73	Black	D1ZZ-7652500-GB	\$204. ⁹⁵ EA
71-73	White	D1ZZ-7652500-GW	\$204. ⁹⁵ EA

FASTBACK QUARTER GLASS ASSEMBLY



Quarter window assembly for Mustang Fastbacks.

Year	Description	Part No.	List
69-70	RH, clear	C9ZZ-6321410-K	\$119. ⁹⁵ EA
69-70	LH, clear	C9ZZ-6321411-K	\$119. ⁹⁵ EA

BACK GLASS



Our back glass is available in clear, factory green tinted, or a new "smoke" version which resembles a modern black tint.

Coupe Back Glass

Year	Description	Part No.	List
64-68	Clear	CSZZ-6542006-C	\$258. ⁹⁵ EA
64-68	Smoke	CSZZ-6542006-S	\$293. ⁹⁵ EA
64-68	Tinted	CSZZ-6542006-T	\$297. ⁹⁵ EA
69-70	Smoke	C9ZZ-6542006-S	\$433. ⁹⁵ EA
69-70	Tinted	C9ZZ-6542006-T	\$433. ⁹⁵ EA

Fastback Back Glass

Year	Description	Part No.	List
65-66	Tinted	CSZZ-6342006-T	\$439. ⁹⁵ EA
65-66	Clear	CSZZ-6342006-C	\$439. ⁹⁵ EA
65-66	Smoke	CSZZ-6342006-S	\$484. ⁹⁵ EA
67-68	Tinted	C7ZZ-6342006-T	\$299. ⁹⁵ EA
67-68	Clear	C7ZZ-6342006-C	\$439. ⁹⁵ EA
69-70	Tinted	C9ZZ-6342006-T	\$299. ⁹⁵ EA
69-70	Clear	C9ZZ-6342006-C	\$369. ⁹⁵ EA
69-70	Smoke	C9ZZ-6342006-S	\$484. ⁹⁵ EA

PLASTIC CONVERTIBLE TOP REAR WINDOW



Plastic windows feature heavy duty 40 gauge clear plastic trimmed with premium 38 ounce material and a zipper assembly.

Part No.	Year	Description	List
CSZZ-7652500-PB	64-66	Black	\$122. ⁹⁵ EA
CSZZ-7652500-PW	64-66	White	\$122. ⁹⁵ EA
C7ZZ-7652500-PB	67-68	Black	\$154. ⁹⁵ EA
C7ZZ-7652500-PW	67-68	White	\$154. ⁹⁵ EA
D1ZZ-7652500-PB	71-73	Black	\$114. ⁹⁵ EA
D1ZZ-7652500-PW	71-73	White	\$114. ⁹⁵ EA

WE PROUDLY FEATURE AUTHENTIC MUSTANG REPRODUCTIONS FROM SCOTT DRAKE!



WIPERS

WASHER COMPONENTS

FORD LICENSED WINDSHIELD WASHER BAG



High quality rubberized vinyl bag, with silk screened FoMoCo logo. An exact copy of the original unit



Year	Description	Part No.	List
64-65	White FoMoCo, twist cap	C1AZ-17618-EA	\$19.95 ^{EA}
66	White FoMoCo, flip cap	C1AZ-17618-EA	\$19.95 ^{EA}
66-67	Gold Ford logo, flip cap, concours	C1AZ-17618-D	\$29.95 ^{EA}
66-67	Gold Ford logo, flip cap, economy	C7ZZ-17618-DR	\$23.95 ^{EA}

WINDSHIELD WASHER HOSE CONNECTOR



Injection molded high strength plastic connector for hoses leading to nozzles. Just like the factory pieces.

Year	Part No.	List
64-66	COAB-17A601-A	\$1.50 ^{EA}
67	C7SZ-17A601-A	\$1.50 ^{EA}
68-70	C8OZ-17A601-A	\$1.50 ^{EA}
71-73	D1ZZ-17A601-A	\$1.50 ^{EA}

WINDSHIELD WASHER HOSE KIT



Made from high quality E.P.D.M. rubber with factory style ribbing along the length of each hose.

Kits include proper connector for each year. Hoses are cut to correct length.

Year	Part No.	List
64-66	C5ZZ-17601/5	\$6.95 ^{KI}
67-68	C7ZZ-17601/5	\$7.50 ^{KI}
69-70	C9ZZ-17601/5	\$7.50 ^{KI}
71-73	D1ZZ-17601/5	\$7.50 ^{KI}

FORD LICENSED COMPLETE WINDSHIELD WASHER KIT



Good looking and very complete. Kit includes washer bag, wiper hoses, wiper nozzle's and windshield wiper spacer and nuts.

Year	Part No.	List
64-65	KIT-WIP-1*	\$55.95 ^{KI}
66	KIT-WIP-2*	\$49.95 ^{KI}

WINDSHIELD WASHER NOZZLE



These are excellent reproductions of the original rubber-tipped and later metal-tipped nozzles. Bright cadmium finish for corrosion protection. Sold in pairs.

Year	Description	Part No.	List
64-65	Rubber tips	C5ZZ-17603-D	\$18.50 ^{PR}
66	Steel tips	C5ZZ-17603-E	\$14.00 ^{PR}
67	Correct copper tubing w/ black plating	C7ZZ-17603-A	\$15.95 ^{PR}
68	Correct copper tubing / black plating	C7ZZ-17603-B	\$23.95 ^{EA}
69	Steel tips	C9ZZ-17603-A	\$15.95 ^{PR}
70	Steel tips	D0ZZ-17603-A	\$15.95 ^{PR}
71-73	Black plastic	D1ZZ-17603-A	\$14.95 ^{PR}

WINDSHIELD WASHER NOZZLE TIP



Molded rubber replacement tips.

Year	Description	Part No.	List
64-65	Rubber	C5AZ-17A602-B	\$5.95 ^{PR}

WINDSHIELD WASHER PUMP

Original style washer pumps made to last.



64-65: 1 speed
C4AZ-17664-A

List
\$38.95^{EA}



65-66: 2 speed
C5AZ-17664-A

List
\$52.95^{EA}



69-73: 2 speed
C5AZ-17664-A

List
\$21.95^{EA}

WINDSHIELD WASHER PUMP REPAIR



Replacement diaphragm for under-dash foot operated pump.

Year	Part No.	List
67-68	C7ZZ-17664-RP	\$14.95 ^{EA}

WIPER HOSE FIREWALL GROMMET



Year	Part No.	List
67-68	C7ZZ-17545	\$5.50 ^{EA}

WINDSHIELD WASHER PUMP HARNESS



Supplies power to washer pump.

Part No.	Year	Description	List
C5ZZ-17290-A	64-65		\$7.95 ^{SE}
C6ZZ-17290-A1	66	1 speed	\$11.95 ^{EA}
C6ZZ-17290-A2	66	2 speed	\$15.95 ^{EA}

FORD LICENSED WINDSHIELD WASHER RESERVOIR

Blow Molded Plastic Features Exact Detail With FoMoCo logo.



67-68: w/ FoMoCo logo
C7OZ-17618-A



List
\$34.95^{EA}

67-68: No logo
C7OZ-17618-R

List
\$29.95^{EA}



69-70: Reservoir
C9ZZ-17618-A



List
\$34.95^{EA}

WINDSHIELD WASHER RESERVOIR BRACKET



Stamped steel, painted black enamel.

Year	Part No.	List
65-66	C4AZ-17651-A	\$5.95 ^{EA}

WINDSHIELD WASHER RESERVOIR

CAP



This stamped aluminum cap secures tightly unlike the original and it looks great.

Year	Part No.	List
64-65	C1AZ-17618-CAP	\$4.50 ^{EA}

WIPER COMPONENTS

EXTERNAL WIPER BEZEL NUT TOOL



Specially designed for removing or installing wiper bezel nuts, without risk of scratching or damaging bezel or paint.

Year	Part No.	List
64-65	T-120-BL	\$17.95 ^{EA}

WINDSHIELD WIPER ARM



Excellent reproductions of the originals, with stainless steel arm construction.

Year	Description	Part No.	List
64-65	Smooth end cap, polished	C1SZ-17526-A	\$16.95 ^{EA}
66-70	Flanged end cap, polished	C1SZ-17526-B	\$16.95 ^{EA}
66-70	Flanged end cap, satin	C1SZ-17526-S	\$17.95 ^{EA}

WINDSHIELD WIPER ARM AND BLADE KIT



A convenient kit which makes sales easy. Each kit contains two wiper arms and two blade assemblies.

Year	Description	Part No.	List
64-65	Stainless	KIT-WIP-5	\$54.95 ^{KI}
66-68	Stainless	KIT-WIP-6	\$54.95 ^{KI}

WINDSHIELD WIPER BEZEL AND NUT KIT



These are perfect reproductions of the originals. Bezels are pressure cast in zinc and then finely chrome plated. Nuts are chromed plated brass. Sold in sets with two bezels and two nuts.

Year	Part No.	List
64-65	CSZZ-17514-K	\$14.95 ^{SE}

WINDSHIELD WIPER BLADE ASSEMBLY



Good quality Trico Assembly. Stainless steel construction. Includes one wiper blade assembly and one rubber blade.

Year	Description	List
65-68	15" length	\$16.50 ^{EA}
69-70	16" length	\$15.95 ^{EA}
71-73	18" length	\$13.95 ^{EA}

WINDSHIELD WIPER BLADE REFILL



Quality name brand replacement blades. Made in the U.S.A. by Trico.

Year	Description	Part No.	List
64-68	15" length	C3AZ-17593-C	\$10.95 ^{PR}
69-70	16" length	C9AZ-17593-A	\$10.95 ^{PR}
71-73	18" length	D1ZZ-17593-A	\$10.95 ^{PR}

WINDSHIELD WIPER MOTOR



Replacement 2-speed wiper motor for all 1967-70 Mustangs.

Year	Part No.	List
67-70	C7ZZ-17508	\$114.95 ^{EA}

WINDSHIELD WIPER PIVOT SEAL



Wiper seals are high quality and reliable. Originals were leather.

Year	Description	Part No.	List
64-70	Rubber/foam	CSZZ-17A475-B	\$2.95 ^{PR}
64-66	Leather	CSZZ-17A475-BL	\$13.50 ^{PR}
67-70	Leather	C7ZZ-17A475-BL	\$13.50 ^{PR}

WINDSHIELD WIPER SWITCH RETAINING NUT



This beautifully chromed nut holds the wiper switch into the dash. This nut is almost always damaged from improper tools used for removal and installation. Made from original factory prints.

Year	Part No.	List
65-66	C4DZ-17512-A	\$13.95 ^{EA}

WINDSHIELD WIPER SWITCH



Year	Description	Part No.	List
64-65	1 speed w/out washer	CSZZ-17A553-B	\$39.95 ^{EA}
65-66	1 speed w/ washer	CSZZ-17A553-C	\$36.95 ^{EA}
65-66	2 Speed w/ washer	CSZZ-17A553-D	\$49.95 ^{EA}
67	2 Speed	C7ZZ-17A553-A	\$59.95 ^{EA}
68	2 Speed	C8ZZ-17A553-A	\$59.95 ^{EA}
69	2 Speed	C9ZZ-17A553-A	\$49.95 ^{EA}
70	2 Speed	D0ZZ-17553-A	\$49.95 ^{EA}
71-73	2 speed	D1ZZ-17553-A	\$49.95 ^{EA}

VARIABLE WINDSHIELD WIPER SWITCH



Wiper switches for multiple applications.

Year	Description	Part No.	List
64-66	1 speed w/ control for washer	CSZZ-17A553-V1	\$64.95 ^{EA}
64-66	Variable, 2 speed w/ control for washer	CSZZ-17A553-V2	\$69.95 ^{EA}
69-70	Variable speed w/ control for washer	C9ZZ-17A553-V2	\$64.95 ^{EA}
71-73	Variable speed w/ control for washer	D1ZZ-17A553-V2	\$64.95 ^{EA}

WIPER BEZEL STEM NUT TOOL



Special tool designed to insert into wiper bezel stem nut used for assembly or disassembly. Will not damage nut.

Year	Part No.	List
64-66	T-110-RD	\$17.95 ^{EA}

WIPER TRANSMISSION ARM



New trans arms for smooth, even motion. Will not fit 1964-1/2

Part No.	Year	List
CSZZ-17566/7-A	65-66	\$99.95 ^{EA}
C7ZZ-17566/7-A	67-68	\$99.95 ^{EA}

WE PROUDLY FEATURE AUTHENTIC MUSTANG REPRODUCTIONS FROM SCOTT DRAKE!



INDEX

AC & Heater Interior Kits	110	Automatic Transmission Overhaul Kit.....	234	Caliper Mounting Brackets.....	16
AC Kit	110	Automatic Transmission Shift Kit.....	235	Caliper Piston, Disc Brake	16
AC Vent.....	116	Automatic Transmission Spacer Plate.....	235	Caliper Rebuild Kit.....	16
Accelerator Cable	94	Axle Bumper.....	223	Car Cover.....	5
Accelerator Linkage	94	Axle Vent, Rear.....	17	Car Cover Antenna Grommet	5
Accelerator Pedal.....	94, 192	Axle, U-Bolt	224	Car Cover Cable With Lock	5
Accelerator Pedal Assembly	94	Back Up Light.....	64	Carburetor Spacer	95
Accelerator Pedal Mounting Screw.....	94	Back Up Light Housing	64	Carpet Kit	141-142
Accelerator Pedal Spring	94	Back Up Light Installation Kit.....	64	Choke Cable	95
Accelerator Return Spring	94	Back Up Light Lens.....	65	Choke Thermostat Shield	95
Accelerator Rod Grommet	94, 186	Back Up Light Lens Gasket.....	65, 193	Choke Tube Kit	95
Accessories	4-8	Back Up Light Lens Pad	193	Cigarette Lighter.....	118
Air Cleaner.....	74-78	Back Up Light Lens Screw.....	65	Cigarette Lighter Bezel.....	118
Air Cleaner Element.....	76	Back Up Light Pigtail	65	Clock Feed Wire.....	58
Air Cleaner Lid Gasket.....	77, 186	Back Up Light Spacer	193	Clock Knob and Screw Set	127
Air Cleaner Shaker Assembly	77, 78	Back Up Light Switch	65	Clock Lens	126
Air Cleaner To Snorkel Nut	77	Backing Plate Axle Gasket.....	17, 235	Clock, Dash	126
Air Cleaner Wing Nut.....	77	Ball Joint Kit, Upper	219	Clock, Wall.....	5
Air Conditioner Belt.....	88	Basic Repaint Kit	186	Clutch Anti-Rattle Spring.....	228
Air Conditioner Blower Switch.....	117	Battery Apron Plate	198	Clutch Cable Conversion Kit.....	230
Air Conditioner Compressor Clutch Brushes...	113	Battery Cable Kit.....	68	Clutch Equalizer Bar.....	227
Air Conditioner Compressor Conversion Kit....	113	Battery Clamp Bolt Kit.....	69	Clutch Equalizer Bar Felt Washer.....	228
Air Conditioner Compressor Cover.....	115	Battery Cover	69	Clutch Equalizer Bar Mount Kit.....	228
Air Conditioner Condenser.....	112	Battery Cover Terminal Extenders.....	69	Clutch Equalizer Bar to Pedal Rod.....	227
Air Conditioner Condenser Hose Grommet	112	Battery Fender Shield.....	69	Clutch Equalizer Pivot Bracket.....	227
Air Conditioner Condenser Mount Bracket.....	112	Battery Hold Down Bolt	69	Clutch Equalizer Repair Kit.....	228
Air Conditioner Drain Hose.....	114	Battery Hold Down Clamp	69	Clutch Equalizer Socket.....	228
Air Conditioner Dryer.....	114	Battery Tray	69	Clutch Equalizer Socket Retainer.....	228
Air Conditioner Feed Harness	118	Battery Tray Mounting Kit	68	Clutch Fan Bolt	30
Air Conditioner Hose Straps.....	113	Bedding And Glazing Compound.....	184	Clutch Fork.....	228
Air Conditioner Register.....	118	Bezel and Knob Kit, Dash.....	118	Clutch Fork Pivot.....	228
Air Conditioner Thermostat.....	118	Bezel Installation Tool	119	Clutch Kit.....	228
Air Conditioner Vacuum Motor.....	119	Blower Motor Fan Switch, Heater	115	Clutch Lever Dust Boot.....	228
Air Conditioner Vacuum Switch	119	Body Molding Kit.....	321	Clutch Pedal	164, 226
Air Vent Assembly	119	Books	175-178	Clutch Pedal Bumper	164, 227
Air Vent Inlet Gasket	119	Brake And Clutch Pedal Bushing	21, 227	Clutch Pedal Pad	164, 226
Alternator Belt	81	Brake and Clutch Pedal Pad	41, 342	Clutch Pedal Pad Trim	164, 226
Alternator Bracket	81	Brake And Clutch Pedal Support	21, 165	Clutch Pedal Repair Shaft	226
Alternator Fan	81	Brake And Fuel Line Clip Kit.....	21	Clutch Pedal Return Spring.....	226
Alternator Fan and Pulley Kit.....	81	Brake Booster with Disc Brake MC.....	17	Clutch Pedal Roller Bearing Rebuild Kit	226
Alternator Harness	68	Brake Disc Conversion Kit.....	26, 27	Clutch Pedal Stop	227
Alternator Mounting Kit.....	81	Brake Distribution Block	12, 13	Clutch Pedal Support Bushing Repair Kit	227
Alternator Pulley	81	Brake Drum	16	Clutch Pilot Bushings	228
Alternator Terminal Cover	68	Brake Dust Shield, Disc	15	Clutch Rod.....	228
Aluminum Liquid Line	112	Brake Extension Lead	18	Clutch Rod Adapter	228
Antenna	8	Brake Hose Clip Kit.....	18	Clutch Rod Bushing	227
Antenna Base Grommet.....	187	Brake Hose, Drum.....	17	Clutch Rod to Firewall Seal	227
Arm Rest Base	48	Brake Hose, Rear	17	Clutch Sets	228
Arm Rest Base and Pad Kit	48	Brake Hub Grease Cap.....	16	Clutch Spring	228
Arm Rest Base To Door Panel Screw	109	Brake Light Switch Adapter	18	Coil Spring.....	218
Arm Rest Pad To Base Screw Kit.....	109	Brake Line And Fuel Line Clip.....	18	Coil Spring Insulator	218
Arm Rest Pads.....	48, 49	Brake Line Clip and Grommet Kit, Front.....	18	Coil Spring Perch	219
Arm Rest Plug	49	Brake Line Kit	18, 19	Coil Spring Perch Bushing.....	218
Arm Rest Retaining Clips	109	Brake Line Kit, Master Cylinder	14	Coil, Ignition	85
Ash Tray Bumpers.....	193	Brake Line Kit, Power Booster	12, 13	Compressor Clutch Brushes, AC.....	111
Ash Tray Cover, Quarter Panel.....	157	Brake Line Pressure Gauge Kit	14	Compressor Conversion Kit, AC.....	111
Ash Tray Receptacle, Quarter Panel	157	Brake Pad Retainer Plate, Disc.....	15	Compressor Cover, AC	112
Ash Tray, Console.....	163	Brake Pedal	21	Condenser Hose Grommet, AC	110
Ash Tray, Dash.....	119	Brake Pedal Pad.....	21, 192	Condenser Mounting Bracket, AC.....	110
Audio	8-10	Brake Pedal Pad Trim	21, 192	Condenser, AC	110
Auto Trans C4 Torque Converter Nuts.....	235	Brake Pedal Pad Trim	21, 192	Console Ash Tray	161, 162
Automatic Shift Plate Assembly.....	164, 233	Brake Power Conversion Kits.....	12	Console Assembly, Complete	160, 162
Automatic Transmission Flex Plate.....	235	Brake Pressure Switch.....	13	Console Compartment Box	162
Automatic Transmission Inspection Plate	235	Brake Spring And Hold Down Kit.....	16	Console End Cap.....	161
Automatic Transmission Master Rebuild Kit....	234	Brake Wheel Cylinder	17	Console Front Panel.....	161
		Brakes	10-21	Console Interior Panel.....	161
		Bumper Section	22-23	Console Harness Feed.....	58
		Bumper Sticker.....	4	Console Housing	160
		Caliper Cross Over Line, Disc Brake.....	16	Console Insert.....	162
		Caliper Dust Seal Retainer.....	16	Console Interior Harness	58, 163

Console Lamp Lens.....	58	Dash Knob & Bezel Kit.....	118	Door Latch Screw	46, 169
Console Mounting Bracket.....	161	Dash Molding Clip Kit.....	118	Door Latch Spring.....	46
Console Mounting Kit.....	161	Dash Pads.....	117	Door Lock Cylinder Retainer.....	172
Console Pad.....	162	Dash Panel.....	125, 130	Door Lock Knob.....	46, 135
Console Rear Lamp Assembly.....	58	Dash Panel Assembly.....	118	Door Lock Knob Grommet.....	46, 135
Console Restoration Kit.....	161	Dash Panel Bezel.....	130	Door Lock Rod.....	46
Console Roll Up Door.....	162	Dash Panel Emblem.....	131	Door Panel.....	46-47
Console Shift Plate.....	161, 162, 233	Dash Panel Heater Control Plate Insert.....	130	Door Panel Clip.....	48
Console Shift Side Seal.....	163, 233	Dash Panel Insert.....	131	Door Panel Cup.....	49
Console Shifter Selector Rod.....	163	Dash Panel Nut.....	108	Door Panel Cup Bracket, Deluxe.....	49
Console Upper Plate.....	162	Dash Panel Repair Plate.....	9	Door Panel Cup Pad.....	49
Console, Center.....	160	Dash Panel Trim.....	130	Door Panel Emblem.....	49
Control Arm Bolts, Lower.....	219	Dash Spacer Bar, AC.....	116	Door Panel Insert.....	50
Control Arm, Lower.....	219	Decal Kit.....	36	Door Panel Remover.....	185
Control Arm, Upper.....	219	Decal, Air Cleaner.....	36	Door Panel U-Cup.....	50
Control Panel Bezels and Lenses.....	119	Decals.....	35-41	Door Panels, Pony.....	46
Control Valve to Cylinder Hose.....	209	Defroster Control Cable.....	115	Door Parts.....	41-54
Convertible Header Molding.....	26	Defroster Duct.....	115	Door Pull Brace, Inner.....	50
Convertible Inner Frame Patch.....	199	Defroster Duct Clip.....	115	Door Pull End Cap Kit.....	50
Convertible Parts.....	24-28	Defroster Hose.....	115	Door Pull Inserts, Woodgrain.....	50
Convertible Pillar Seal.....	28, 190	Differential Gasket.....	236	Door Pull, Deluxe.....	50
Convertible Pump Motor And Reservoir.....	25	Differential Rebuild Kit.....	235	Door Shaft Assembly.....	42
Convertible Quarter Panel Snap Kit.....	26	Differential Seal Kit.....	235	Door Shell, Complete.....	203
Convertible Tack Strip, Front.....	27	Disc Brake Calipers.....	15, 16	Door Sill Plate Screw.....	108
Convertible Tack Strip, Rear.....	27	Disc Brake Conversion Kit, Front.....	10, 11	Door Skin.....	203
Convertible Top.....	27-28	Disc Brake Conversion Kit, Rear.....	12	Door Speaker Crossover Harness.....	54
Convertible Top Boot.....	24	Disc Brake Proportioning Valve.....	13	Door Striker Assembly.....	44
Convertible Top Boot Bag.....	24, 237	Disc Brake Push Rod Set, Adjustable.....	14	Door Tag Plate.....	54
Convertible Top Boot Rear Molding.....	26	Disc Brake System.....	10-16	Door Tag Plate Rivets.....	54
Convertible Top Boot Snap Kit.....	24	Discharge Hose, AC.....	112	Door To Window Seal, Front.....	52, 187
Convertible Top Clamp Truss Head Repair Kit... ..	25	Distributor.....	83	Door Water shield.....	48
Convertible Top Clamp Truss Head Screw.....	25	Distributor Cap.....	83	Drain Hole Cover.....	201
Convertible Top Clevis Pin Kit.....	25	Distributor Clamp.....	83	Drip Rail Molding.....	180
Convertible Top Dowel Pin.....	25	Distributor Primary Lead Pigtail.....	69	Drip Rail Molding Joint Cover.....	180
Convertible Top Harness.....	24	Distributor Tune Up Kit.....	83	Driveline Safety Loop.....	236
Convertible Top Harness, Under Hood.....	24	Distributor Vacuum Advance.....	83	Drum Brake Hub.....	16
Convertible Top Header Seal.....	28, 190	Dome Light Assembly.....	58, 159	Drum Brake Shoe.....	16
Convertible Top Hold Down Clamp.....	25	Dome Light Housing.....	58, 159	Dryer Mounting Bracket.....	112
Convertible Top Hook.....	25	Door Access Plug.....	54	Dryer, AC Filter.....	112
Convertible Top Hydraulic Cylinder.....	25	Door Bumper.....	51	Eleanor Gas Cap Conversion Kit.....	97
Convertible Top Hydraulic Hose Line.....	25	Door Courtesy Light Assembly.....	50	Electric Fan And Shroud Kit.....	31
Convertible Top Latch Assembly.....	25	Door Edge Guard.....	5	Electric Trunk Release Kit.....	172
Convertible Top Latch Handle.....	25	Door Glass.....	245	Electrical & Lighting.....	54-71
Convertible Top Latch Mounting Base.....	25	Door Glass Assembly.....	245	Emblem Barrel Clip.....	105
Convertible Top Latch Spring.....	26	Door Glass Bumper.....	97	Emblem Kit.....	71, 72
Convertible Top Pad.....	27	Door Glass Mount Kit (1970).....	51, 245	Emblem Mounting Clips, Grille.....	73
Convertible Top Rear Window.....	26, 246	Door Glass Run Channel, Front.....	53	Emblem, Shelby Seat Belt Insert.....	75
Convertible Top Seal Kit.....	28, 190	Door Glass Run Inserts, Front.....	51, 188	Emblem, Steering Wheel Hub.....	75
Convertible Top Seal Tube Nut Set.....	28	Door Handle & Window Crank Spring.....	43	Emblems.....	71-75
Convertible Top Seal Washer Set.....	28	Door Handle & Window Crank, Inside.....	42, 43	Emergency Brake Components.....	19-21
Convertible Top Switch.....	24, 119	Door Handle Bezel.....	44, 49	Emergency Flasher Knob.....	120
Convertible Top Tension Cable.....	26	Door Handle Clip Remover.....	43	Emergency Flasher Switch.....	61
Convertible Visor Pivot Arm.....	26	Door Handle Shaft Assembly.....	42, 133	Engine.....	75-89
Convertible Visor Rod.....	26	Door Handle Spring Clip.....	44	Engine Dress Up Kit.....	78, 79
Cooling System.....	29-34	Door Handle, Inside.....	42	Engine Gasket, Full Set.....	82
Corso Feroce Steering Wheels.....	120-121	Door Handle, Outside.....	45	Engine Gauge Feed Harness.....	69
Courtesy Light Bracket.....	159	Door Hinge.....	44	Engine Master Fastener Kit.....	84
Courtesy Light Harness.....	58	Door Hinge Bushing.....	44	Engine Mount.....	85
Courtesy Light Switch Socket.....	61	Door Hinge Mount Kit.....	44, 108	Engine Mount Bracket.....	85
Cowl Brace To Cowl Hardware.....	222	Door Hinge Pin.....	44	Engine Mount Bracket to Body Bolts.....	85
Cowl Cover.....	4, 199	Door Hinge Repair Kit.....	44	Engine or Trunk Light.....	70
Cowl Panel.....	199	Door Hinge Repair Spring.....	44	Engine To Firewall Ground Wire.....	70
Cowl Side Panel.....	199	Door Hinge Spring Compressor.....	185	Evaporator, AC.....	112
Cowl To Hood Seal.....	187	Door Inner Upper Trim.....	50	Evapo-Rust.....	185
Cowl Vent Repair Kit.....	200	Door Latch Assembly.....	45, 169	Exhaust Bracket, Rear Upper.....	93
Cowl Vent Repair Panel.....	200	Door Latch Lock Rod.....	45, 169	Exhaust Hanger.....	93
Cowl-Hood Grounding Strap.....	58, 103	Door Latch Reinforcement Kit.....	45, 170	Exhaust Hanger Insulator.....	93
Custom Fiberglass Body Kit.....	208	Door Latch Retainer Bushing Kit.....	45, 169	Exhaust Hanger Retainer.....	93
Custom Front Support Bracket.....	207	Door Latch Rod Retainer.....	45, 169	Exhaust Headers.....	90-91

**WE PROUDLY FEATURE AUTHENTIC MUSTANG
REPRODUCTIONS FROM SCOTT DRAKE!**



Exhaust Kit.....	91, 92	Fog Light Housing Assembly.....	54	Glove Box.....	132
Exhaust Manifold.....	90	Fog Light Housing Assembly, Tri-Bar.....	54	Glove Box and Trunk Lock.....	132-171
Exhaust Manifold Gasket.....	91	Fog Light Housing Rim.....	55	Glove Box Button Bezel.....	132
Exhaust Manifold Heat Riser.....	91	Fog Light Switch.....	55	Glove Box Decal.....	131
Exhaust Manifold Heat Riser Stud.....	91	Fog Light Switch Bezel Tool.....	184	Glove Box Door.....	132
Exhaust Manifold Locking Tab.....	90	Fog Light Wiring Feed.....	55	Glove Box door Bumpers.....	191
Exhaust Pipe Clamp.....	93	Fog Light Wiring Ground.....	55	Glove Box Door Cable.....	132
Exhaust Pipe Flange Gasket.....	91	Fog Light Wiring Pigtail.....	55	Glove Box Door Inserts.....	132
Exhaust Pipes, "H" & "Y".....	91	Fog Light Wiring Under-Dash Harness.....	55	Glove Box Lamp.....	133
Exhaust Port Divider.....	89	Fold Down Seat Carpet, Fastback.....	142	Glove Box Latch.....	132, 171
Exhaust System.....	90-93	Fold Down Seat Latch, Fastback.....	152	Glove Box Lock.....	132, 171
Exhaust Tips.....	92	Fold Down Seat Molding, Fastback.....	152	Glove Box or Trunk Lock Set.....	132, 171
Expansion Valve.....	112	Frame Crossmember.....	199	Glove Box Screw Kit.....	132
Export Brace.....	221	Frame Crossmember Bolts.....	199	Glove Box Striker Set.....	132
Export Brace Mounting Plate.....	222	Frame Rail with Torque Box, Rear.....	202	Glovebox Striker Kit.....	132
Exterior Trim Screw Kit.....	105	Frame Rail Patch, Rear.....	202	Grant Horn Button.....	124, 216
External Wiper Bezel Nut Tool.....	184, 251	Frame Rail, Front.....	199	Grant Hub Kit.....	123, 216
Fan Blade.....	31	Frame Rail, Full Rear.....	202	Grant Steering Wheel.....	123, 216
Fan Clutch.....	30	Frame Rail, Over Axle.....	202	Grant Steering Wheel Adapter.....	123, 216
Fan Shroud.....	31	Front Cross Member.....	198	Grant Tilt Column Adapter.....	218
Fan Shroud Bracket.....	31	Front Fender Extension Molding.....	197	Grille.....	101
Fan Spacer.....	61	Front License Bracket.....	196	Grille Bar.....	102
Fastback Door Glass Molding.....	180	Front Seat Hinge Shaft Retainer Clip Set.....	151	Grille Bar Mounting Bracket.....	102
Fastback Rear Interior Panels.....	154	Front Seat Washer.....	151	Grille Corral (and Horse).....	101
Fastback Rear Quarter Panel Bracket.....	205	Front Spoiler.....	5	Grille Corral LED Light Kit.....	57, 101
Fastback Rear Seat Bottom Bracket.....	205	Front Suspension Bumper.....	219	Grille Emblem.....	101
Fastback Seat Bumpers.....	191	Front Valve.....	195	Grille Emblem Mounting Clips.....	101
Fastback Seat Latch Bumper.....	191	Front Valve Mounting Kit.....	105	Grille Horse.....	101, 102
Fastback Trap Door Bumpers.....	191	Front Wheel Bearing and Race.....	247	Grille Molding.....	102
Fender.....	106	Fuel Cap.....	99-100	Grille Molding And Trim.....	102
Fender And Body Bolt.....	105	Fuel Filler Flange Gasket.....	97	Grille Molding Center Joint Cover.....	102
Fender And Valve Bolt, Small.....	199	Fuel Filler Hose.....	97	Grille Mounting Clip.....	103
Fender Apron Bracket.....	198	Fuel Filler Pipe To Trunk Floor Seal.....	97	Grille Mounting Kit.....	103
Fender Apron, Front.....	198	Fuel Filter.....	95	Grille Support Bracket.....	103
Fender Apron, Rear.....	199	Fuel Filter, Sending Unit.....	98	Hardware.....	103-109
Fender Bolts, Billet.....	104	Fuel Line Bracket.....	97	Harmonic Damper.....	83
Fender Bracket, Inner Front.....	198	Fuel Line Grommet.....	97	Harmonic Damper Spacer.....	83
Fender Covers.....	4	Fuel Line, Pump To Carburetor.....	96	Hats.....	6
Fender Emblem.....	72-73	Fuel Line, Tank To Pump.....	96	Head Pipe Hanger Bracket.....	91
Fender Extension Molding.....	197	Fuel Pipe Hose Clamp.....	97	Head Rest.....	148
Fender Extension Seal.....	186	Fuel Pump.....	96	Headers.....	89-90
Fender Splash Shield Kit.....	186	Fuel Pump Filter Canister.....	96	Headlight.....	55
Fender To Body Pillar Pad.....	186	Fuel Pump Mounting Gasket.....	96	Headlight Adjusters.....	56, 106
Fender to Bumper Fillers.....	45, 197	Fuel Pump Mounting Kit.....	107	Headlight Adjusting Kit.....	56, 106
Fender To Cowl Bolt.....	105	Fuel Pump Rebuild Kit.....	96	Headlight Adjusting Nut.....	56, 106
Fender To Cowl Nut Set.....	105	Fuel System.....	94-100	Headlight Assembly Gill Trim.....	5
Fender, Lower Rear Corner Of.....	196	Fuel Tank.....	98	Headlight Assembly Hardware Kit.....	56
Fender, Reproduction.....	196	Fuel Tank Filler Kit.....	98	Headlight Bucket.....	56
Fiberglass Body Kits.....	208	Fuel Tank Filler Mount Screw.....	98	Headlight Bucket Assembly.....	56, 197
Filler Tube, Fuel.....	97	Fuel Tank Mounting Kit.....	98	Headlight Bucket Housing.....	56, 197
Fire Extinguisher Mount.....	6	Fuel Transfer Line.....	97	Headlight Dimmer Switch.....	56
Fire Extinguisher Mount Clamps.....	6	Fuse Box Repair Kit.....	59	Headlight Dimmer Switch Cover Pad.....	56, 191
Firewall.....	200	Gas Cap.....	99-100	Headlight Door.....	56, 197
Firewall Air Conditioner Hose Grommet.....	112	Gas Cap Lock.....	100	Headlight Door Retainer Clip Kit.....	107
Firewall Grommet Bracket.....	112	Gas Tank.....	98	Headlight Door Screw Kit.....	107
Firewall Insulation Fasteners.....	108, 191	Gauge Pod Assembly, 1967 Under Dash.....	129	Headlight Retaining Ring.....	56
Firewall Insulator.....	141, 200	Gauge Pod Bracket, 1967 Under Dash.....	129	Headlight Switch.....	57
Firewall To Hood Bumpers.....	187	Gauge Pod Face Plate, 1967 Under Dash.....	129	Headlight Switch Bezel.....	57
Flasher, Turn Signal.....	61	Gauge, Amperage.....	127	Headlight Switch Knob.....	57
Flashlight Mount.....	6	Gauge, Fuel.....	127	Headlight Switch Retaining Nut.....	57
Floor Console.....	160, 162	Gauge, Oil Pressure.....	127	Headlight Wiring Harness.....	57
Floor Extension, Front.....	200	Gauge, Speedometer Overlay.....	128	Headliner.....	156
Floor Extension, Rear.....	203	Gauge, Tachometer, Hood.....	128	Headliner Bow.....	156
Floor Frame Support, Inner.....	201	Gauge, Temperature.....	128	Headliner Glue.....	156
Floor Mat.....	142-143	Gear Box Cover Seal.....	208	Headliner Insulation Pad.....	156
Floor Pan.....	200	Gear Box, New.....	208	Headliner Pillar Trim Set.....	157
Floor Pan Support.....	200	Generator Belt.....	80	Headliner Rod Retainer.....	156
Fog Light Bar.....	101	Generator Splash Shield.....	186	Headliner Trim Side Panel.....	157
Fog Light Bulb.....	54	Glass, Windows.....	224-246	Heater & AC Control Knobs.....	111

Heater & AC Interior Kits	109, 111	Horn Switch, Rim Blow	61, 216	License Plate Light Lens	165
Heater & AC Vacuum Line Hose Kit	117	Horn, Electric	70	License Plate Mounting Kit	107
Heater Blower Motor	114	Hub Cap	240-244	License Plate Nut Fastener	107
Heater Blower Motor to Firewall Nut	114	Hub Trim & Emblem, Steering Wheel	122	Light Bulb	62
Heater Box Assembly	114	Hub Trim, Steering Wheel	123	Light Bulb Pricing Table	62
Heater Box Case Clamp	115	Idler Arm	209	Literature	175-178
Heater Cable Clamp Bracket Kit	103	Idler Arm Bracket	209	Lock Kit, Door	170
Heater Control Cable	115	Idler Arm Bushing	209	Lock Kit, Door & Ignition	170
Heater Control Valve	113	Idler Arm Mount Kit	209	Lock Kit, Door, Ignition And Trunk	171
Heater Core	114	Idler Bearing Repair Kit	112	Lock Kit, Glovebox And Trunk	171
Heater Core End Cap	114	Idler Pulley And Bracket	112	Lock Kits, Multiple Door & Ignition	170
Heater Core To Control Valve Hose	113	Ignition Bezel Tool	184	Lower Control Arm	219
Heater Dash Plate	116, 130	Ignition Coil	82	Lower Instrument Panel Pad	118
Heater Hose	114	Ignition Cylinder And Keys	171	Lower Panel In Front Of Rear Wheel	204
Heater Hose Kit	114	Ignition Switch	61	Lower Steering Column Cover	123, 213
Heater Hose Plug, Firewall	114	Ignition Switch Bezel	119, 171	Lug Nut	243
Heater Inlet Gasket	115	Ignition Switch Pigtail	61	Lug Nut Kit, Locking	245
Heater Jumper Harness	115	Ignition Switch Retainer	61, 171	Luggage Rack	5
Heater Plenum	115	Ignitor Conversion	82	Luggage Tote Bag	236
Heater Resistor Assembly	115	Inner Structure Of Fender	197	Magnetic Sign, Mustang	6
Heater Seal Kit	114	Inside Door Handle & Window Crank Screw	108	Magnum Hub Cap	243
Heating & AC	109-117	Inside Rearview Mirror Adhesive	184	Magnum 400 Alloy Wheels	242
Hinges, Door	44	Instrument Bezel	125	Magnum 500 Alloy Wheels	242
Hinges, Hood	194	Instrument Bezel Mounting Set	125	Manual Steering Adapter	208
Hinges, Trunk	206	Instrument Bezel Top Retaining Clips	126	Manual Transmission Master Rebuild Kit	229
Hog Ring Kit	150	Instrument Bezel, Custom 6 Hole	125	Manual Transmission Overhaul Kit	229
Hood	193-194	Instrument Cluster Loom	59	Manual Transmission Spacer Plate	229
Hood Bumper	186	Instrument Lens	126	Manual, Convertible Top Repair	173
Hood Hinge	194	Instrument Lens Anti-Rattle Pad	126, 191	Manuals, Assembly	173-174
Hood Hinge Mounting Kit	107, 194	Instrument Lens Retainer Bezel	126	Marker Light Lens Gasket	63, 187
Hood Hinge Spring	194	Instrument Panel and Glove Box Insert	125	Marker To Body Seal	63, 187
Hood Latch	194	Instrument Panel Circuit, Printed	59	Master Body Kit	105
Hood Latch Pin	195	Instrument Panel LED Lights	60	Master Chassis Kit	104
Hood Latch Support Brace	195	Instrument Panel Light Filter	126	Master Cylinder	13
Hood Letters	73	Instrument Panel Set	130	Master Cylinder Cap	15
Hood Lock Bracket	173	Instrument Voltage Regulator	60	Master Cylinder Pushrod Bushing	14
Hood Molding	179	Insulation	141, 200	Mirrors	179-181
Hood Molding Support	179	Intake Manifold	86	Mirrors w/Led Signals	180
Hood Pin Kit	172	Intake Manifold Bolt Kit	86, 103	Molding Hardware	180
Hood Plenum	77	Intake Manifold Gasket	86	Molding Remover	185
Hood Prop Rod	163, 195	Intake Manifold Washer Kit	86	Molding Retainer Clip	179, 190
Hood Safety Latch	195	Interior Door Dye, AccuMatch™	182	Moldings, Exterior	181-183
Hood Scoop	194	Interior Fastener Kit	108	Monte Carlo Bar	220
Hood Scoop Emblem	74	Interior LED Lights	60	Motor Mounts	85
Hood Scoop Grille	194	Interior Parts & Upholstery	118-171	Muffler	92
Hood Scoop Seal	186	Interior Prep	183	Neutral Safety Switch	62, 233
Hood Seal Retainer Clip	187	Interior Quarter Panel	154, 155	Neutral Safety Switch Harness	61, 233
Hood Turn Signal Harness	58	Interior Trim Screw Kit	108	Nose Bracket, Shelby	196
Hood Turn Signal Insert Grille	194	J Nut Fastener	105	Nose Reinforcement	196
Hood Turn Signal Light Assembly	58	Jack Bag	236	Oil Cap	79-80
Hood Turn Signal Light Gasket	186	Jumper Cable Bag	237	Oil Cap Adapter	80
Hood Twist Lock	172	Key	171	Oil Cap PCV Elbow	80
Hood Twist Lock Catch	173	Key Chain and Fobs	7, 8	Oil Cap To Air Cleaner Hose	80
Hood Twist Lock Retainer	173	Keys, Locks & Latches	169, 172	Oil Dip Stick Tube, Engine	86
Horn Button Rubber Spring Pad	123, 215	Kick Down Cable	233	Oil Dip Stick, Engine	87
Horn Button Spring	215	Kick down Lever	233	Oil Drain Plug	87
Horn Contact Insulator	215	Kick Panel Speaker	10	Oil Filter	87
Horn Contact Spring	215	Kick Panel Trim	144	Oil Pan	87
Horn Lens Insulator	215	Kick Panels	10, 143, 144	Oil Pan Bolt Kit	87
Horn Panel Bezel	123	Knock Off Hub Cap	245	Oil Pan Gasket Kit	87
Horn Panel Bezel Button	123	Leaf Spring	222-223	Oil Pressure Extension Lead	70
Horn Panel Pad	123, 214	Leaf Spring Bushing Kit	224	Oil Pressure Sender Extension	88
Horn Ring Button	121, 214	Leaf Spring Eye Bolt	224	Oil Pressure Sending Unit	70, 88
Horn Ring Center Pad	123, 214	Leaf Spring Eye Bushing	224	Outside Door Handle Pad	189
Horn Ring Contact Kit	215	Leaf Spring Plate	223	Outside Mirror Base Pad	178
Horn Ring Retainer	215	Leaf Spring Shackle Bushing	224	Outside Mirror Mounting Kit	178
Horn Ring Retainer Screw	108	License Plate Bumper	193	Outside Mirror	177-179
Horn Switch	61, 216	License Plate Frame	4	Overhead Console Assembly	59
Horn Switch Trim Plate	216	License Plate Light Gasket	193	Overhead Console Map Light	160

**WE PROUDLY FEATURE AUTHENTIC MUSTANG
REPRODUCTIONS FROM SCOTT DRAKE!**



Overhead Console Overlay	160	Quarter Panel Reflector	63	Rear Wheel Bearing.....	17, 235
Overhead Console Panel	160	Quarter Panel Skin	205	Rear Window Louver Bottom Latch	207
Overhead Map Light Switch.....	59	Quarter Panel Trim	154	Rear Window Louver Kit.....	206
Owners Manual.....	176	Quarter Panel Trim Cap	154, 155	Rear Window Louver Pad.....	206
Owners Manual Wallet.....	5	Quarter Panel Windlace	155	Rear Window Louver Seal.....	206
Package Tray.....	156	Quarter Vent Louvers, Upper.....	204	Rear Window Louver Upper Hinges	207
Package Tray w/Speaker Pads.....	156	Quarter Window Anchor Bolt, FB.....	43	Rear Window Molding Kit.....	181
Paint Stick, Markal.....	185	Quarter Window Molding	180	Rear Window Seal.....	190
Paint, AccuMatch™ Detail.....	184-185	Quarter Window Seal	189	Red Accent Light.....	59
Paint, Tools & Restoration Supplies.....	184-187	Quarter Window Seal, Door Glass To	189	Reinforcement Pan, Convertible.....	201
Panel Behind Rear Window.....	208	Quarter Window To Body Seal	190	Reinforcement Plate, Convertible	201
Park and Turn Signal Light, LED.....	64	Quarter Window Trim.....	180	Remote Control Mirror	178
Park Light Bezel.....	64	Quarter Window Vent Handles	43	Remote Mirror Bezel.....	178
Park Light Kit, Complete	65	Quick Disconnect Fitting	111	Repaint Kit.....	186
Park Light Lens	64	Racing Mirror	178	Return Spring Bracket.....	94
Park Light Lens Gasket.....	64, 189	Rack and Pinion Kit	211	Rev Limiter Repair Pigtail.....	70
Park Light Lens Kit.....	62	Radiator.....	33-34	Rim Blow Steering Wheel	122
Park Light Lens Screw.....	64	Radiator And Heater Hose Clamp Set.....	29	Rims.....	239-243
Park Light Seal.....	63, 187	Radiator Cap.....	31	Rocker Molding.....	180
Parking Light Components.....	19-21	Radiator Cap With Electrolysis Protection	32	Rocker Panel.....	202
Parking Light Retainer	63, 197	Radiator Coolant Filter.....	29	Roll Bar	146
Parts Tag, Mustang.....	5	Radiator Drain Valve	32	Roof Brace	203
PCV Fitting	80	Radiator Hose Set.....	29, 30	Roof Emblem	74
PCV Hose	80	Radiator Hose Set with Wire Clamps	30	Roof Panel, Fastback.....	203
Pedal Covers, Billet.....	166	Radiator Insulator.....	32	Roof Rail Seal.....	190
Pedal Pivot Assembly.....	94	Radiator Mounting Bracket.....	32	Rotor, Disc Brake.....	15
Pillar Molding.....	157	Radiator Mounting Kit.....	32	Rubber Grommet Kit.....	191
Pillar Post Pad.....	157	Radiator Support	198	Rubber Parts	188-195
Pony Door Panel Cups	49	Radiator Support To Hood Bumper	187	Rust Remover.....	185
Pony Door Panels	46	Radiator Support To Hood Seal.....	186	Seat Access Hole Plug.....	191
Power Brake Booster	12, 13	Radio.....	8	Seat Adjuster Knob	152
Power Brake Booster Seal, Push Rod	14	Radio Bezel	9, 130	Seat Back Adjusting Kit	151
Power Brake Booster Vacuum Line.....	13	Radio Knob and Dial Set	9, 119	Seat Backboard	150
Power Brake Conversion Kit.....	12	Radio Molding, Center Dash.....	129	Seat Belt	144, 145
Power Brake Conversion Line And Fitting	12	Rally Pac.....	128	Seat Belt Anchor Plate	202
Power Steering Ball and Stud Repair Kit	212	Rally Pac Center Dial.....	129	Seat Belt Bolt Set	144
Power Steering Belt	88	Rally Pac Clock Bulb.....	129	Seat Belt Buckle Bezel.....	145
Power Steering Control Valve.....	212	Rally Pac Dual Gauge Housing	129	Seat Belt Buckle Button Cover.....	145
Power Steering Control Valve Seal Kit.....	212	Rally Pac Lenses	129	Seat Belt Buckle Restoration Kit	145
Power Steering Conversion Kit.....	211	Rally Pac Mounting Clamp	129	Seat Belt Holder	146
Power Steering Cylinder Boot and Clamp	212	Rally Pac Mounting Kit.....	129	Seat Bottom Frame	151
Power Steering Cylinder Boot Kit	212	Rally Pac Repair Pigtail Kit.....	129	Seat Button	151
Power Steering Cylinder Seal Kit.....	212	Rally Pac Theft Protection Screw.....	129	Seat Cushion	150
Power Steering Drop Bracket.....	213	Rally Pac Trim Ring.....	129	Seat Frame	151
Power Steering Frame Rail Compression Nut.....	212	Rally Pac Under Dash Harness	129	Seat Hinge Cover	151
Power Steering Hose	210	Ram Air Hood Seal	186	Seat Hinge Repair Bracket.....	151
Power Steering Hose Insulator	210	Rear Cross Member.....	204	Seat Latch Handle and Bezel Set	151
Power Steering Mount Bolt.....	211	Rear End Housing Nut And Washer Kit	109	Seat Platform.....	201
Power Steering Pump Cap	210	Rear End Lowering Kit	224	Seat Platform, Convertible	201
Power Steering Pump Dipstick.....	210	Rear End Vent Hose Kit	236	Seat Side Molding	151
Power Steering Pump Housing	210	Rear License Plate Dust Shield.....	193	Seat Side Molding Mount Kit.....	151
Power Steering Pump Mounting Bracket	211	Rear Seat Guide, Fastback.....	152	Seat Springs.....	151
Power Steering Socket Sleeve	210	Rear Seat Hardware, Fastback.....	152	Seat Track Assembly	152
Power Steering to Frame Bushing.....	213	Rear Seat Latch Cover Plate, Fastback.....	152	Seat Track Plate	152
Pressure Plate Bolt Set	107	Rear Seat Latch Knob, Fastback.....	152	Seat Track Spring Set.....	152
Primer	183	Rear Seat Support, Fastback.....	152	Seat Upholstery.....	146-150
Proportioning Valve Rebuild Kit.....	13	Rear Spoiler.....	5, 207	Seat Upholstery Wire Bolster Set	150
Push Rod, Master Cylinder Adjustable.....	14	Rear Spoiler Mounting Bracket.....	207	Self Adjuster Repair Kit.....	17
Quarter Glass.....	246	Rear Spoiler Mounting Gasket.....	207	Sending Unit Float	98
Quarter Glass Pivot Rod Cover.....	154	Rear Spoiler Mounting Hardware Kit.....	207	Sending Unit Gasket.....	98
Quarter Panel.....	204	Rear Trim Panel, Fastback	153	Sending Unit Retaining Ring.....	98
Quarter Panel Drain Plug	192	Rear Valance	206	Sending Unit, Fuel Tank.....	98
Quarter Panel Extension	205	Rear Valance Fastener	107	Sequential Tail Light Kit.....	66
Quarter Panel Extension Nut.....	205	Rear Valance Mounting Kit.....	107	Serrated Flange Nut.....	105
Quarter Panel Extension Seal.....	193	Rear Vertical Glass Run Repair Kit.....	51, 189	Service Valve Caps, AC	111
Quarter Panel Grille Gasket.....	189	Rear View Mirror.....	158	Service Valve, AC.....	111
Quarter Panel Light Lens, Fastback.....	59	Rear View Mirror and Arm Kit.....	159	Shackle Kit.....	224
Quarter Panel Light, Fastback.....	59	Rear View Mirror Arm	159	Shaker Air Cleaner Assembly	77
Quarter Panel Ornament	180	Rear View Mirror Mount	177	Shaker Air Cleaner Base, Metal	78

Shaker Air Cleaner Seal.....	78, 186	Smog Pump Filter.....	88	Sun Visor Tip.....	191
Shaker Flapper Pivot Rod.....	75	Sound Deadener Kit.....	140, 200	Sun Visor, Convertible.....	158
Shaker Flapper Plate.....	75	Spare Tire Cover.....	236	Sun Visor, Coupe and Fastback.....	158
Shaker Hood Trim Ring.....	78	Spare Tire Mounting Bolt.....	237	Surface Cleaner.....	183
Shaker Intermediate Plate.....	78	Spark Plug Wire Separator.....	83	Suspension.....	220-226
Shaker Top Scoop.....	78	Spark Plug Wire Sets.....	84	Sway Bar Bushing.....	222
Shaker Vacuum Motor.....	78	Speaker.....	9	Sway Bar Bushing Kit.....	222
Sheet Metal & Body Parts.....	195-209	Speaker Grille, Door.....	10	Sway Bar End Link.....	222
Shelby Mustang Guide.....	176	Speaker Grille, Rear.....	10	Sway Bar, Front.....	222
Shift Boot Retainer.....	164	Speedo Cable Retainer.....	231	Sway Bar, Rear.....	222
Shift Cover Screw.....	109	Speedometer Cable.....	231	T5 Conversion Kit.....	230
Shift Indicator Light.....	163	Speedometer Gear.....	231	Tach Dash Bracket, Shelby.....	129
Shift Lever Grommet.....	225	Speedometer Gear Retaining Clip.....	231	Tags.....	38-39
Shift Lever Rebuild Kit.....	225	Splash Shield.....	197	Tail Light 3 Bulb Inserts.....	65
Shift Lever Shoulder Bolt.....	225	Splash Shield Support Bracket, Rear.....	197	Tail Light Bezel.....	66
Shifter Assembly.....	232	Spoiler Gasket.....	192	Tail Light Bezel Screw.....	66
Shifter Assembly, Automatic.....	232	Sport Deck Bracket, Rear.....	152	Tail Light Honeycomb Panel.....	181
Shifter Bezel and Knob Kit.....	163, 232	Sport Mirror Bezel Nut.....	178	Tail Light Honeycomb Panel Molding Clips.....	181
Shifter Boot.....	225	Spray Adhesive.....	184	Tail Light Housing.....	67
Shifter Boot Retainer.....	226	Spring Perch, High Performance.....	218	Tail Light Housing Gasket.....	193
Shifter Boot, Lower.....	225	Starter Bolt.....	104	Tail Light Housing Mounting Nut.....	67
Shifter Bracket.....	225	Starter Solenoid.....	70	Tail Light Housing Spacer.....	67
Shifter Bushing, Auto.....	232	Starter Solenoid Cable Brackets.....	68	Tail Light Housing To Body Seal.....	67, 193
Shifter Button.....	231	Steering.....	210-219	Tail Light Lens.....	67-68
Shifter Cable.....	232	Steering Box.....	210	Tail Light Lens & Bezel Kit.....	67
Shifter Cover Assembly.....	232	Steering Box Frame Bolts and Washers.....	210	Tail Light Lens Gasket.....	67, 193
Shifter Cover Retaining Plate.....	232	Steering Box Rebuild Kit.....	210	Tail Light Panel.....	206
Shifter Dial.....	232	Steering Center Link.....	210	Tail Light Panel With Corner Drip Rails.....	206
Shifter Handle, Automatic.....	232	Steering Column to Firewall Seal.....	215	Tail Light Panel Bracket.....	206
Shifter Interlock Washer, 4-Speed.....	226	Steering Column to Floor Grommet.....	215	Tail Light Panel Molding.....	181
Shifter Knob, Manual.....	224	Steering Column to Gear Box Insulator.....	215	Tail Light Panel Molding Clips.....	181
Shifter Lever, Manual.....	225	Steering Coupler.....	212	Tail Light Panel, LED.....	66
Shifter Linkage Retaining Clip.....	226	Steering Coupler Assembly.....	212	Tail Light Pigtail.....	68
Shifter Linkage Rod.....	233	Steering Coupler Bolt and Nut.....	212	Tail Light Retaining Bolt.....	67
Shifter Linkage, Manual.....	226	Steering Shaft Spring.....	215	Tail Light Wiring Harness.....	68
Shifter Mount Plate.....	226	Steering Wheel Assembly.....	122	Tension Rod Anti-Rattler.....	192
Shifter Mounting Plate Extension.....	226	Steering Wheel Assembly, Pony.....	122	Thermostat.....	34
Shifter Plate Assembly, Console.....	161, 223	Steering Wheel Center.....	122	Thermostat Housing.....	34
Shifter Seal.....	223	Steering Wheel Collar.....	122	Thermostat Housing Bolt.....	34
Shifter Selector Rod, Automatic.....	232	Steering Wheel Emblem.....	121-123	Thermostat Housing Gasket.....	34
Shifter Spring.....	109	Steering Wheel Horn Contact Plate.....	215	Tie Rod Adjusting Sleeve.....	209
Shifter, Manual.....	225, 226	Steering Wheel Hub Trim.....	123	Tie Rod End Dust Seal.....	209
Shock Access Hole Plug.....	191	Steering Wheel Insulator Hardware Kit.....	215	Tie Rods.....	209
Shock Tower And Apron Assembly.....	198	Steering Wheel Insulator Kit.....	215	Tilt Away Steering Vacuum Canister.....	216
Shock Tower Bolt.....	104	Steering Wheel Nut.....	213	Tilt Steering Column.....	124
Shock Tower Brace.....	221	Steering Wheel, Standard.....	122, 213	Timing Chain Sets.....	85
Shock Tower Cap.....	198, 221	Steering Wheel, Wood.....	120-122, 215-217	Timing Cover.....	86
Shock Tower Nut.....	104	Stencil Kit, GT.....	39	Timing Cover Gasket.....	86
Shock Tower Patch, Inner.....	198	Stereo Adapter, Ipod.....	8	Tire Pressure Gauge.....	5
Shock Tower With Bracket.....	198	Stereo Adapter, USB Flash.....	9	TMI Upholstery.....	166-169
Shock Tower, Outer.....	198	Stone Deflector.....	196	Tool Kit Bag.....	237
Shocks.....	199	Stone Deflector Bracket.....	196	Top Fender Hardware Kit.....	105
Shop Manuals.....	173	Stone Deflector Mounting Kit.....	106	Top Vent Rivet Tool.....	185
Show Quality Die Cast Center Caps.....	243	Stop Light Switch.....	18	Top Vent Seat Tool, Glass Run.....	185
Shroud, Fan.....	31	Striker Assembly, Door.....	44	Top Vent Window Seal.....	188
Side Marker Bezel.....	64	Strip Body Caulking.....	184	Torque Box.....	200
Side Marker Lens.....	64	Stripe Kits.....	39-40	Torque Box Patch, Rear.....	202
Side Marker Light.....	64	Stripe Stencil, Hood.....	40	Torque Box, Upper Rear.....	202
Side Marker Socket.....	64	Strut Rod Bracket.....	198, 220	Transition Pan.....	203
Side Scoop, Functional.....	207	Strut Rod Bushing.....	220	Transmission & Drivetrain.....	227-237
Side Scoop, Non Functional.....	207	Strut Rods.....	220	Transmission Cluster Gear.....	229
Side Scoop, Shelby.....	207	Styled Steel Hub Cap.....	244	Transmission Countershaft Pin.....	230
Sight Glass Hose.....	111	Styled Steel Hub Cap Emblem.....	245	Transmission Crossmember Bar.....	230
Sill Plate.....	140	Styled Steel Wheel Accent.....	245	Transmission Dip Stick.....	234
Sill Plate Emblem.....	140	Styled Steel Wheel Cover.....	244	Transmission Dip Stick Tube.....	234
Sill Plate Screw.....	140	Styled Steel Wheel Cover Hub Cap.....	244	Transmission Filter.....	234
Smog Diverter Valve.....	88	Sub Frame Connector.....	223	Transmission Flywheel.....	229
Smog Ferrule and Nut.....	88	Sun Shade.....	5	Transmission Flywheel Bolts.....	229
Smog Pump Belt.....	88	Sun Visor Bracket, Center.....	158	Transmission Fulcrum, T5.....	230

**WE PROUDLY FEATURE AUTHENTIC MUSTANG
REPRODUCTIONS FROM SCOTT DRAKE!**



Transmission Gear.....	230	Under Hood Seal Kit.....	187	Wheel Spacer.....	246
Transmission Input Shaft.....	229	Undercoating, AccuMatch™.....	183	Wheel Stud, Front Drum.....	17
Transmission Kick Down Cable Kit.....	233	Under-Dash Harness.....	60	Wheelhouse.....	207
Transmission Mainshaft.....	229	Under-Dash Harness, Air Conditioner.....	60	Wheels.....	241-246
Transmission Mount.....	230	Under-Dash Reminder Light, Seat Belt.....	60	Windlace.....	157
Transmission Mount Bolts.....	109, 230	Under-Hood Stainless Trim.....	89	Window Channel Strips.....	53
Transmission Oil Cooler Fitting.....	234	Underhood Turn Signal Wiring Clips.....	71	Window Crank & Door Handle Back Plate.....	44
Transmission Oil Cooler Hose Kit.....	234	Underlayment Kit, Carpet.....	140, 200	Window Crank Handle Cover Plate.....	44
Transmission Oil Cooler Line.....	234	Upholstery, Seat.....	146-150, 167-168	Window Crank, Door.....	43
Transmission Oil Line Bracket.....	234	Upper Control Arms.....	219	Window Crank, Quarter.....	43
Transmission Oil Line Retainer Clip.....	234	Upper Panel Joint Cover, Fastback.....	153	Window Glass.....	53
Transmission Pan.....	233	Vacuum Modulator.....	235	Window Grommet.....	53
Transmission Ring Gear.....	229	Vacuum Modulator Line.....	235	Window Guide.....	51
Transmission Spacer Plate Conversion Kit.....	230	Vacuum Canister.....	117	Window Moldings.....	180-181
Transmission Support.....	201	Vacuum Line Hose Kit.....	117	Window Regulator Retainer Clip.....	42
Transmission Synchronizer.....	229	Valance To Frame Bracket.....	196	Window Regulator Scissor Assembly.....	43
Transmission Synchronizer Fork.....	229	Valance, Front.....	195	Window Regulator, Door.....	42
Trap Door Hinge, Fastback.....	153	Valance, Rear.....	206	Window Roller & Clip.....	43
Trap Door Latch, Fastback.....	153	Valve Cover.....	78-79	Window Sealer.....	184
Trap Door Prop Assembly.....	153	Valve Cover Bolt.....	104	Windows.....	246-249
Trap Door Prop Rod.....	153	Valve Cover Gasket.....	79	Windshield And Body Sealant.....	184
Trap Door, Fastback.....	153	Valve Cover Grommet.....	79	Windshield Bottom Stops (1969-70).....	179
Trap Door, Fastback w/Speaker.....	10, 154	Valve Stems, Short Chrome.....	244	Windshield Filler Panel Moldings.....	180
Trim Adhesive Spray, Super.....	184	Vent Glass.....	245	Windshield Glass.....	247
Trip Reset Button Assembly.....	126	Vent Grill, Fastback Interior.....	153	Windshield Pillar Molding, Convertible.....	180
Trunk Brace and Cross Member, Convertible.....	204	Vent Seal Edge Rivet.....	88	Windshield Seal.....	190
Trunk Brace, Convertible.....	204	Vent Slide, Fastback.....	153	Windshield Sealant.....	184
Trunk Bumper Brace.....	204	Vent Window Bracket.....	52	Windshield Washer Bag.....	250
Trunk Carpet Kit.....	239	Vent Window Channel.....	51, 188	Windshield Washer Hose Connector.....	250
Trunk Compartment.....	238-240	Vent Window Division Bar Seal.....	52, 188	Windshield Washer Hose Kit.....	250
Trunk Divider and Package shelf.....	203	Vent Window Frame.....	52	Windshield Washer Kit.....	250
Trunk Filler Board.....	239	Vent Window Frame & Glass Assy.....	52, 245	Windshield Washer Nozzle.....	250
Trunk Floor Drop Off.....	203	Vent Window Frame To Door Seal.....	52, 188	Windshield Washer Nozzle Tip.....	250
Trunk Floor, Complete.....	203	Vent Window Glass Frame.....	52	Windshield Washer Pump.....	250
Trunk Latch.....	172, 238	Vent Window Handle.....	52	Windshield Washer Pump Harness.....	250
Trunk Latch Striker.....	172, 238	Vent Window Seal.....	52, 188	Windshield Washer Reservoir, Ford Licensed.....	250
Trunk Lid.....	206	Vent Window Seal Kit.....	52, 188	Windshield Wiper Arm.....	251
Trunk Lid and Quarter Extensions.....	207	Vent Window To Door Seal.....	52, 188	Windshield Wiper Arm and Blade Kit.....	251
Trunk Lid Bumper.....	193	Vented Quarter Panel Trim, Fastback.....	153	Windshield Wiper Bezel and Nut Kit.....	251
Trunk Lid Fill Panel, Fastback.....	206	Vinyl Cleaner.....	185	Windshield Wiper Blade Assembly.....	251
Trunk Lid Hinge.....	206	Vinyl Dye.....	182	Windshield Wiper Blade Refill.....	251
Trunk Lid Prop Rod.....	206, 238	Vinyl Protectant.....	185	Windshield Wiper Motor.....	251
Trunk Lid Springs.....	206	Vinyl Top.....	180	Windshield Wiper Pivot Seal.....	251
Trunk Lock Cylinder.....	171	Vinyl Top Molding.....	180	Windshield Wiper Switch.....	251
Trunk Lock Cylinder Housing Pad.....	193	Voltage Regulator.....	70	Windshield Wiper Switch Retaining Nut.....	251
Trunk Lock Cylinder Sleeve.....	171	Voltage Regulator Cover.....	70	Wiper Bezel Stem Nut Tool.....	184, 251
Trunk Lock Housing Spacer.....	171	Voltage Regulator Mounting Kit.....	71, 104	Wiper Knob.....	118
Trunk Lock Stem Extension.....	171	Voltage Regulator Screw Caps.....	71, 104	Wiper Motor Loom.....	60
Trunk Mat.....	236	Warning Buzzer, Headlight "On".....	57	Wiper Transmission Arm.....	250
Trunk Molding.....	181	Washer Pump Pedal Pad.....	192	Wipers.....	250-251
Trunk Panel.....	203	Water Bypass Hose.....	30	Wire Loom Mounting Kit.....	71
Trunk Rear Corner.....	205	Water Pump.....	30	Wire Spoke Wheel Cover.....	244
Trunk Release.....	172, 238	Water Pump Bolt Kit.....	30	Wiring Clip Master Kit.....	71
Trunk Release, Electronic.....	172, 238	Water Temperature Sending Unit.....	34	Wiring Diagram Manual.....	54
Trunk Release, Wireless.....	172, 238	Watershields.....	48	Wiring Diagram Manual, Large Format.....	54
Trunk Seal.....	192	Weather Stripping, Door.....	52	Wiring Loom Ties.....	71, 104
Trunk Underlayment.....	239	Weather Stripping, Door Bottom.....	52	Yoke.....	231
Trunk Wheelhouse Seam Cover.....	192	Weatherstrip Adhesive.....	53		
Try-Y Headers.....	89	Weatherstrip Fastener.....	29		
T-Shirt, Women's.....	7	Well Liner.....	29		
T-Shirt, Youth.....	7	Well Liner Mounting Set.....	29		
T-Shirts.....	7	Well Liner Tensioning Spring.....	29		
Turn Signal Cancel Cam.....	61	Wheel Beauty Ring.....	241		
Turn Signal Harness Socket.....	61	Wheel Cover.....	243, 245		
Turn Signal Light Lever.....	120	Wheel Cover Emblem.....	243		
Turn Signal Switch.....	62	Wheel Grease Seal, Front.....	17, 244		
U-Joint.....	231	Wheel Lock.....	242		
U-Joint Bolt Kit.....	109, 231	Wheel Opening Molding.....	181		
Under Hood Detailing Kit.....	103	Wheel Seal, Rear Axle.....	17, 246		



Never out of style.™



1965 Mustang with 15 x 6 Magnum 400 wheels



SCOTT DRAKE

Driven Beyond Perfection

